



# RS700A-E13 Series

RS700A-E13-RS12U/RS700A-E13-RS4U

## 1U Rackmount Server User Guide



E25444  
First Edition  
February 2025

**Copyright © 2025 ASUSTeK COMPUTER INC. All Rights Reserved.**

No part of this manual, including the products and software described in it, may be reproduced, transmitted, transcribed, stored in a retrieval system, or translated into any language in any form or by any means, except documentation kept by the purchaser for backup purposes, without the express written permission of ASUSTeK COMPUTER INC. ("ASUS").

ASUS provides this manual "as is" without warranty of any kind, either express or implied, including but not limited to the implied warranties or conditions of merchantability or fitness for a particular purpose. In no event shall ASUS, its directors, officers, employees, or agents be liable for any indirect, special, incidental, or consequential damages (including damages for loss of profits, loss of business, loss of use or data, interruption of business and the like), even if ASUS has been advised of the possibility of such damages arising from any defect or error in this manual or product.

Specifications and information contained in this manual are furnished for informational use only, and are subject to change at any time without notice, and should not be construed as a commitment by ASUS. ASUS assumes no responsibility or liability for any errors or inaccuracies that may appear in this manual, including the products and software described in it.

Product warranty or service will not be extended if: (1) the product is repaired, modified or altered, unless such repair, modification or alteration is authorized in writing by ASUS; or (2) the serial number of the product is defaced or missing.

Products and corporate names appearing in this manual may or may not be registered trademarks or copyrights of their respective companies, and are used only for identification or explanation and to the owners' benefit, without intent to infringe.

# Contents

Safety information.....	vii
About this guide .....	ix

## Chapter 1: Product Introduction

1.1	System package contents.....	1-2
1.2	Serial number label .....	1-3
1.3	System specifications.....	1-4
1.4	Front panel features .....	1-7
1.5	Rear panel features.....	1-7
1.6	Internal features .....	1-8
1.7	LED information .....	1-9
1.7.1	Front panel LEDs .....	1-9
1.7.2	Rear panel LEDs .....	1-10
1.7.3	LAN (RJ-45) LEDs .....	1-10
1.7.4	Storage device status LEDs.....	1-11

## Chapter 2: Hardware Setup

2.1	Chassis cover .....	2-2
2.1.1	Removing the chassis cover .....	2-2
2.1.2	Installing the chassis cover .....	2-4
2.2	Air duct.....	2-6
2.2.1	Removing the air duct .....	2-6
2.2.2	Installing the air duct.....	2-6
2.3	Central Processing Unit (CPU) .....	2-7
2.3.1	Installing the CPU and heatsink .....	2-8
2.4	System memory .....	2-9
2.4.1	Memory configurations.....	2-9
2.4.2	Installing a DIMM .....	2-10
2.4.3	Removing a DIMM .....	2-10
2.5	Front bezel (optional) .....	2-11
2.5.1	Removing the front bezel.....	2-11

# Contents

- 2.6 Storage devices.....2-12**
  - 2.6.1 Installing a 2.5" storage device..... 2-12
  - 2.6.2 Installing a 3.5" storage device (on selected models)..... 2-14
  - 2.6.3 Installing an M.2 SSD module ..... 2-15
- 2.7 Expansion card brackets ..... 2-16**
  - 2.7.1 Removing the expansion card brackets ..... 2-16
- 2.8 Expansion slots ..... 2-17**
  - 2.8.1 Installing a PCIe expansion card..... 2-18
  - 2.8.2 Installing an HBA/RAID card ..... 2-20
  - 2.8.3 Installing a cache vault power module (optional)..... 2-20
  - 2.8.4 Installing an OCP card ..... 2-22
- 2.9 Cable connections ..... 2-24**
  - 2.9.1 Pre-connected system cables ..... 2-25
  - 2.9.2 Storage device configurations and cabling..... 2-27
- 2.10 System fans ..... 2-28**
  - 2.10.1 Removing a system fan..... 2-28
  - 2.10.2 Installing a system fan..... 2-28
- 2.11 Redundant power supply units ..... 2-29**
  - 2.11.1 Removing a power supply unit ..... 2-29
  - 2.11.2 Installing a power supply unit ..... 2-30
- 2.12 Motherboard ..... 2-30**
  - 2.12.1 Removing the motherboard..... 2-30
  - 2.12.2 Installing the motherboard..... 2-31
- 2.13 CMOS battery ..... 2-32**
  - 2.13.1 Replacing the CMOS battery ..... 2-32
- 2.14 Rail kit options ..... 2-32**

# Contents

## Chapter 3: Motherboard Information

3.1	Motherboard layout .....	3-2
3.2	Sockets .....	3-4
3.3	Jumpers .....	3-6
3.4	Internal LEDs.....	3-8
3.5	Internal connectors .....	3-9

## Chapter 4: BIOS Setup

4.1	Managing and updating your BIOS.....	4-2
4.1.1	ASUS CrashFree BIOS 3 Utility.....	4-2
4.1.2	ASUS EZ Flash Utility.....	4-3
4.2	BIOS setup program.....	4-4
4.2.1	BIOS menu screen.....	4-5
4.2.2	Menu bar .....	4-5
4.3	Main menu.....	4-7
4.4	Performance Tuning menu .....	4-8
4.5	Advanced menu.....	4-10
4.5.1	Trusted Computing.....	4-10
4.5.2	Redfish Host Interface Settings .....	4-11
4.5.3	AMD CBS.....	4-12
4.5.4	SMART Settings .....	4-21
4.5.5	UEFI Variables Protection.....	4-21
4.5.6	Serial Port Console Redirection .....	4-22
4.5.7	CPU Configuration .....	4-24
4.5.8	PCI Subsystem Settings.....	4-25
4.5.9	USB Configuration.....	4-26
4.5.10	Network Stack Configuration.....	4-27
4.5.11	NVMe Configuration.....	4-28
4.5.12	SATA Configuration .....	4-28
4.5.13	APM Configuration.....	4-29
4.5.14	AMD Mem Configuration Status.....	4-30
4.5.15	TIs Auth.....	4-30
4.5.16	Driver Health .....	4-31
4.5.17	Third-party UEFI driver configurations .....	4-31

# Contents

<b>4.6</b>	<b>Chipset menu</b> .....	<b>4-32</b>
<b>4.7</b>	<b>Security menu</b> .....	<b>4-33</b>
<b>4.8</b>	<b>Boot menu</b> .....	<b>4-35</b>
<b>4.9</b>	<b>Tool menu</b> .....	<b>4-36</b>
<b>4.10</b>	<b>Event Logs menu</b> .....	<b>4-37</b>
	4.10.1 Change Smbios Event Log Settings.....	4-37
	4.10.2 View Smbios Event Log.....	4-37
<b>4.11</b>	<b>Server Mgmt menu</b> .....	<b>4-38</b>
	4.11.1 System Event Log.....	4-38
	4.11.2 BMC network configuration.....	4-38
	4.11.3 View System Event Log.....	4-38
<b>4.12</b>	<b>Exit menu</b> .....	<b>4-39</b>
 <b>Appendix</b>		
	<b>Block diagram</b> .....	<b>A-2</b>
	<b>Q-Code table</b> .....	<b>A-3</b>
	<b>Notices</b> .....	<b>A-8</b>
	<b>Service and Support</b> .....	<b>A-14</b>

## Safety information

### Electrical Safety

- Before installing or removing signal cables, ensure that the power cables for the system unit and all attached devices are unplugged.
- To prevent electrical shock hazard, disconnect the power cable from the electrical outlet before relocating the system.
- When adding or removing any additional devices to or from the system, ensure that the power cables for the devices are unplugged before the signal cables are connected. If possible, disconnect all power cables from the existing system before you add a device.
- If the power supply is broken, do not try to fix it by yourself. Contact a qualified service technician or your dealer.

### Operation Safety

- Any mechanical operation on this server must be conducted by certified or experienced engineers.
- Before operating the server, carefully read all the manuals included with the server package.
- Before using the server, ensure all cables are correctly connected and the power cables are not damaged. If any damage is detected, contact your dealer as soon as possible.
- To avoid short circuits, keep paper clips, screws, and staples away from connectors, slots, sockets and circuitry.
- Avoid dust, humidity, and temperature extremes. Place the server on a stable surface.
- If you encounter technical problems with the product, contact a qualified service technician or your retailer.

---

**CAUTION:** This product is equipped with a three-wire power cable and plug for the user's safety. Use the power cable with a properly grounded electrical outlet to avoid electrical shock.

---

### Restricted Access Area

This equipment should only be installed in a Restricted Access Area where both these conditions apply:

- Access can only be gained by skilled or instructed persons who have been instructed about the reasons for the restrictions applied to the area and about any precautions that shall be taken; and
- Access is through the use of a TOOL, or other means of security, and is controlled by the authority responsible for the area.

### Lithium-Ion Battery Warning

CAUTION! Danger of explosion if battery is incorrectly replaced. Replace only with the same or equivalent type recommended by the manufacturer. Dispose of used batteries according to the manufacturer's instructions.

### Heavy System

CAUTION! This server system is heavy. Ask for assistance when moving or carrying the system.

### Shock Hazard



CAUTION! Risk of electric shock.



Disconnect all power supply input plugs before servicing.

## Optical Drive Safety Information

### Laser Safety Information



---

**CAUTION:** To prevent exposure to the optical drive's laser, do not attempt to disassemble or repair the optical drive by yourself. For your safety, contact a professional technician for assistance.

---



# About this guide

## Audience

This user guide is intended for system integrators, and experienced users with at least basic knowledge of configuring a server.

## Contents

This guide contains the following parts:

**1. Chapter 1: Product Introduction**

This chapter describes the general features of the server, including sections on front panel and rear panel specifications.

**2. Chapter 2: Hardware Setup**

This chapter lists the hardware setup procedures that you have to perform when installing or removing system components.

**3. Chapter 3: Motherboard Information**

This chapter gives information about the motherboard that comes with the server. This chapter includes the motherboard layout, jumper settings, and connector locations.

**4. Chapter 4: BIOS Setup**

This chapter tells how to change system settings through the BIOS Setup menus and describes the BIOS parameters.

## Conventions

To ensure that you perform certain tasks properly, take note of the following symbols used throughout this manual.



**DANGER/WARNING:** Information to prevent injury to yourself when trying to complete a task.



**CAUTION:** Information to prevent damage to the components when trying to complete a task.



**IMPORTANT:** Instructions that you **MUST** follow to complete a task.



**NOTE:** Tips and additional information to help you complete a task.

## Typography

### Bold text

Indicates a menu or an item to select.

### Italics

Used to emphasize a word or a phrase.

### <Key>

Keys enclosed in the less-than and greater-than sign means that you must press the enclosed key.

Example: <Enter> means that you must press the Enter or Return key.

### <Key1>+<Key2>+<Key3>

If you must press two or more keys simultaneously, the key names are linked with a plus sign (+).

Example: <Ctrl>+<Alt>+<Del>

### Command

Means that you must type the command exactly as shown, then supply the required item or value enclosed in brackets.

Example: At the command prompt, type the command line: **format A: /S**

## References

Refer to the following sources for additional information and for product and software updates.

### 1. ASUS Control Center (ACC) user guide

This manual tells how to set up and use the proprietary ASUS server management utility. Visit [asuscontrolcenter.asus.com](http://asuscontrolcenter.asus.com) for more information.

### 2. ASUS websites

The ASUS websites worldwide provide updated information for all ASUS hardware and software products. Refer to the ASUS contact information.

# Product Introduction

# 1

This chapter describes the general features of the server. It includes sections on front panel and rear panel specifications.

## 1.1 System package contents

Check your system package for the following items.

<b>Model name</b>	<b>RS700A-E13</b>
Chassis	ASUS 1U rackmount chassis
Motherboard	ASUS K15PP-D24 server board
Accessories	1 x Set of screws 1 x CPU air duct 2 x PSU air ducts 2 x CPU heatsinks 2 x AC power cables 2 x 80 PLUS PSU
Optional items	1 x 1U full-pull ball bearing rail kit

**NOTE:** If any of the above items is damaged or missing, contact your retailer.

## 1.2 Serial number label

When requesting support from the ASUS Technical Support Team, provide the product's serial number. The serial number has 12 characters, such as xxSxxxxxxxxx, and is printed on the asset tag. Refer to the below illustration for the location of the asset tag.

### RS700A-E13-RS4U

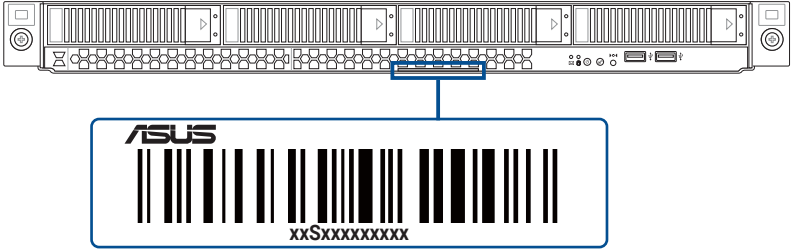

### RS700A-E13-RS12U

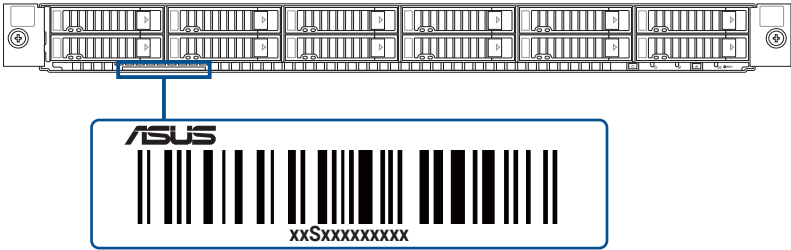

## 1.3 System specifications

The ASUS RS700A-E13 series features the ASUS K15PP-D24 server board designed for AMD EPYC™ 9005 series processors.

Model name		RS700A-E13
Motherboard		K15PP-D24
Processor support		2 x Socket SP5 (LGA 6096P) AMD EPYC™ 9005 series processors xGMI (External Global Memory Interface Link) * Up to 500W TDP, TDP support varies by configuration
Memory	Total slots	24 (12 channels per CPU, 12 DIMMs per CPU, 1DPC)
	Capacity	Maximum up to 3072GB
	Memory type	DDR5 6400/5600 RDIMM/3DS RDIMM, up to 6000MT/s * Refer to ASUS server AVL for the latest update
	Memory size	128GB, 96GB, 64GB, 32GB RDIMM/3DS RDIMM * Refer to ASUS server AVL for the latest update
Expansion slots	Total PCIe slots	4 PCIe slots
	Slot type	2 x PCIe (Gen5 x16 link, FHHL) 2 x OCP 3.0 (SFF)
	M.2	2 x M.2 sockets (Gen3 x4 link, 22110/2280/2260)
	microSD	1 microSD slot
Storage	Motherboard connectors	<b>All models:</b> 2 x M.2 sockets (Gen3 x4 link, 22110/2280/2260) 6 x M.2 sockets (Gen3 x4 link, 22110/2280/2260) 6 x M.2 sockets (Gen3 x4 link, 22110/2280/2260) 6 x M.2 sockets (Gen3 x4 link, 22110/2280/2260) <b>RS700A-E13-RS12U:</b> 12 x SATA 6Gb/s ports <b>RS700A-E13-RS4U:</b> 4 x SATA 6Gb/s ports
	Backplane connectors	<b>RS700A-E13-RS12U:</b> 6 x M.2 sockets (Gen3 x4 link, 22110/2280/2260) 3 x SlimSAS x4 (for SATA) <b>RS700A-E13-RS4U:</b> 2 x M.2 sockets (Gen3 x4 link, 22110/2280/2260) 1 x SlimSAS x4 (for SATA)

(continued on the next page)

Model name		RS700A-E13
Storage	Storage bays	<b>RS700A-E13-RS12U:</b> 12 x 2.5" hot-swap storage bays (front) SKU1: Supports 12x NVMe SKU2: Supports 4x SATA/SAS* + 8x NVMe/SATA/SAS* <b>RS700A-E13-RS4U:</b> 4 x 2.5"/3.5" hot-swap storage bays (front) Supports 4x NVMe/SATA/SAS* * SAS support requires an optional HBA/RAID card
	Default cables	<b>RS700A-E13-RS12U:</b> 12x SATA support: 2 x MCIO to SlimSAS cable (optional) <b>RS700A-E13-RS4U:</b> 4x SATA support: 1 x MCIO to SlimSAS cable (optional)
	NVMe upgrade options	<b>RS700A-E13-RS12U:</b> 8x NVMe support: 4 x MCIO cable (optional) 12x NVMe support: 6 x MCIO cable (optional) <b>RS700A-E13-RS4U:</b> 4x NVMe support: 2 x MCIO cable (optional)
	Auxiliary storage	n/a
Networking		1 x Management LAN port 2 x OCP 3.0 adapter (optional)
Onboard graphics		Aspeed AST2600 64MB
I/O ports	Front	<b>RS700A-E13-RS12U:</b> n/a <b>RS700A-E13-RS4U:</b> 2 x USB 5Gbps ports
	Rear	2 x USB 5Gbps ports 1 x Mini DisplayPort 1 x RJ-45 Management LAN port 1 x Debug port
Switch/LED	Front	1 x Power switch w/ LED 1 x Reset switch 1 x Location switch w/ LED 1 x HDD access LED 1 x Message LED
	Rear	1 x Power switch w/ LED 1 x Location switch w/ LED 1 x Message LED
Security Options		Dual BMC module or PFR module (optional) TPM-SPI module (optional) * Default option: Dual BMC module

(continued on the next page)

<b>Model name</b>	<b>RS700A-E13</b>
<b>OS support</b>	Windows® Server, RedHat® Enterprise Linux, SuSE® Linux Enterprise Server, CentOS, Ubuntu, VMWare * Refer to <a href="https://servers.asus.com/support/os">https://servers.asus.com/support/os</a> for the latest supported OS list
<b>Management solutions</b>	<b>Hardware (out-of-band remote management):</b> Onboard ASMB12-iKVM for KVM-over-IP <b>Software:</b> ASUS Control Center Enterprise Classic (optional)
<b>Regulatory compliance</b>	BSMI, CE, CB, RCM, FCC (Class A), ISED
<b>Dimensions</b>	483mm x 43.2mm x 821.7mm / 19.02" x 1.7" x 32.35" (1U)
<b>Net weight</b>	13.81kg (excluding CPU, DRAM, and storage)
<b>Gross weight</b>	16.71kg (including packaging, excluding CPU, DRAM, and storage)
<b>Power supply and rating</b>	1+1 Redundant 2000W 80 PLUS Titanium/Platinum PSU 100-127V~/220-240V~, 12A/10A (x2), 50/60Hz * <b>Power supply configuration varies by region</b>
<b>Environment</b>	Operating temperature: 10° ~ 35° Non-operating temperature: -40° ~ 60° Non-operating humidity: 20% ~ 90% (Non-condensing)

**NOTE:** Specifications are subject to change without notice.



## 1.4 Front panel features

### RS700A-E13-RS4U

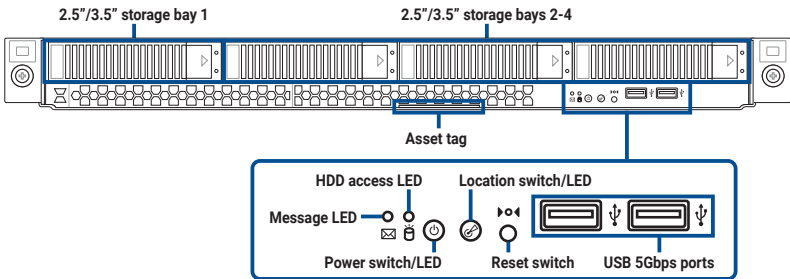

### RS700A-E13-RS12U

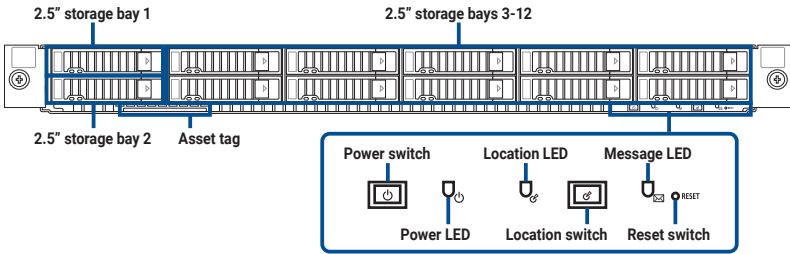

## 1.5 Rear panel features

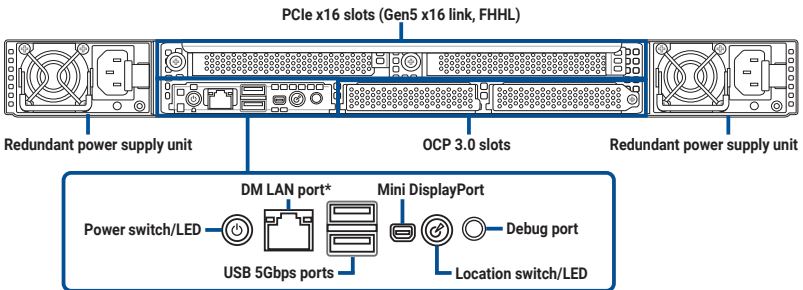

**NOTE:** The DM (Dedicated Management) port is for ASUS ASMB12-iKVM only.

# 1.6 Internal features

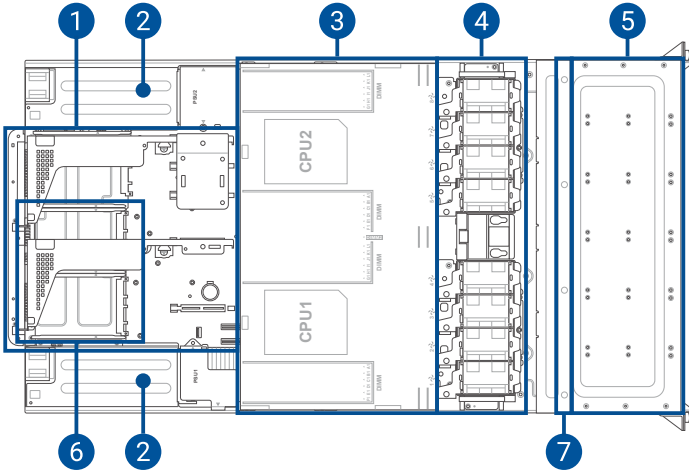

- |                                        |                             |
|----------------------------------------|-----------------------------|
| 1. PCIe expansion card brackets (FHHL) | 5. Storage device bays      |
| 2. Redundant power supply units        | 6. OCP 3.0 slots            |
| 3. Server board                        | 7. Storage device backplane |
| 4. System fans                         |                             |

**NOTE:**

- A protective film is pre-attached to the front cover before shipping. Please remove the protective film before turning on the system for proper heat dissipation.
- The barebone server does not include a floppy disk drive. Connect a USB floppy disk drive to any of the USB ports on the front or rear panel if you need to use a floppy disk.

**WARNING**  
**HAZARDOUS MOVING PARTS**  
**KEEP FINGERS AND OTHER BODY PARTS AWAY**

## 1.7 LED information

### 1.7.1 Front panel LEDs

#### RS700A-E13-RS4U

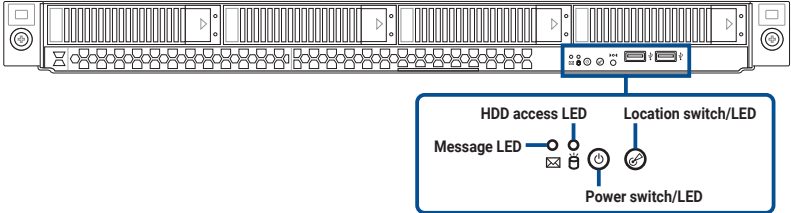

#### RS700A-E13-RS12U

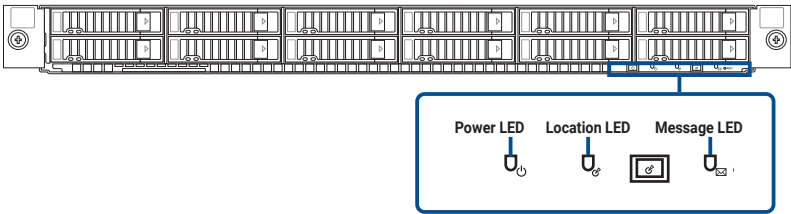

LED	Status	Description
Power LED	ON	System power on
Location LED	ON	Received user command to locate the system
	OFF	Function off
Message LED	ON	A hardware monitor event is indicated
	OFF	System is normal; no incoming event
HDD access LED	Blinking	Storage device reading or writing data
	OFF	No activity

## 1.7.2 Rear panel LEDs

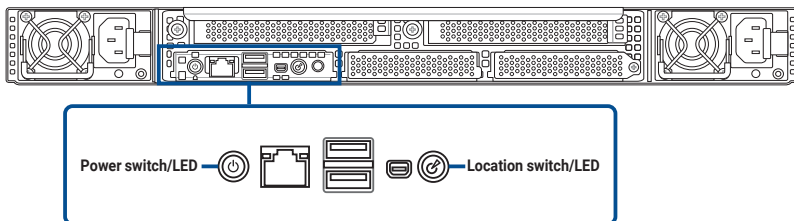

LED	Status	Description
Power LED	ON	System power on
Location LED	ON	Received user command to locate the system
	OFF	Function off

## 1.7.3 LAN (RJ-45) LEDs

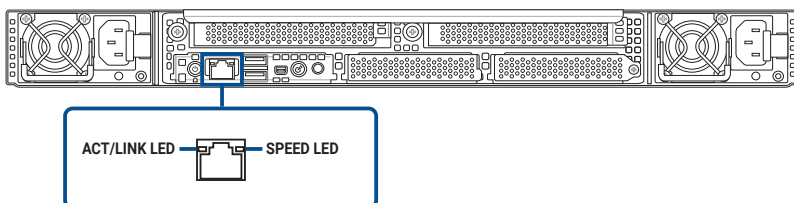

### Dedicated Management LAN port (DM\_LAN1) LEDs

SPEED LED		ACT/LINK LED	
Status	Description	Status	Description
OFF	10 Mbps connection	OFF	No link
ORANGE	100 Mbps connection	ORANGE	Linked
GREEN	1 Gbps connection	BLINKING	Data activity

## 1.7.4 Storage device status LEDs



Storage Device LED Description		
Status (RED)	ON	Storage device has failed
	Blinking	RAID rebuilding or locating
Activity (GREEN)	ON	Storage device power ON
	Blinking	Storage device reading or writing data
	OFF	Storage device not found



# Hardware Setup

# 2

This chapter lists the hardware setup procedures that you have to perform when installing or removing system components.

## 2.1 Chassis cover

**NOTE:** A protective film is pre-attached to the system cover before shipping. Remove the protective film before turning on the system for proper heat dissipation.

### 2.1.1 Removing the chassis cover

1. Turn the screw clockwise to unlock the latch.

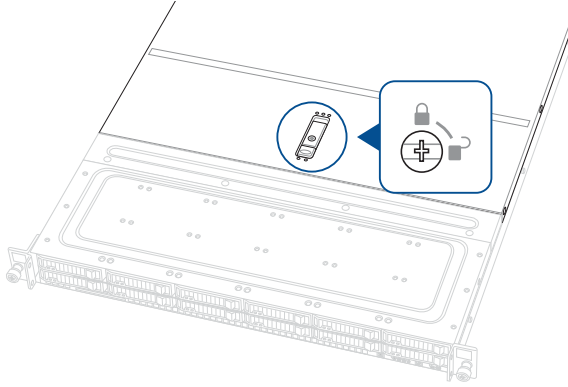

2. Press the spring lock to release the latch, then pull the latch upwards to disengage the chassis cover from the chassis.

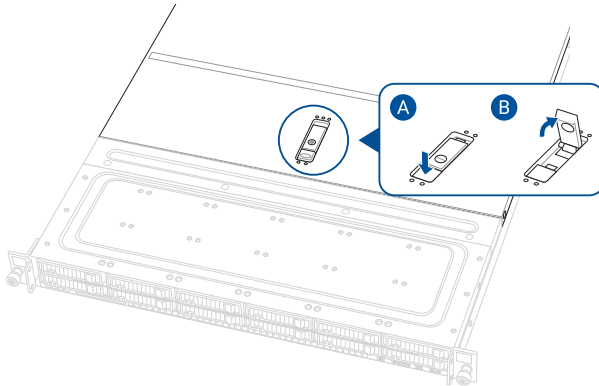



3. Slide the chassis cover towards the rear of the chassis, then lift and remove it from the chassis.

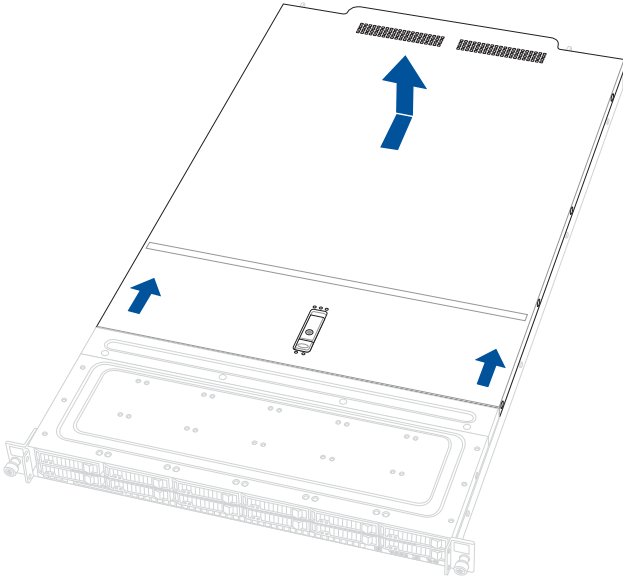

## 2.1.2 Installing the chassis cover

1. Place the chassis cover onto the chassis, then slide the chassis cover towards the front of the chassis.

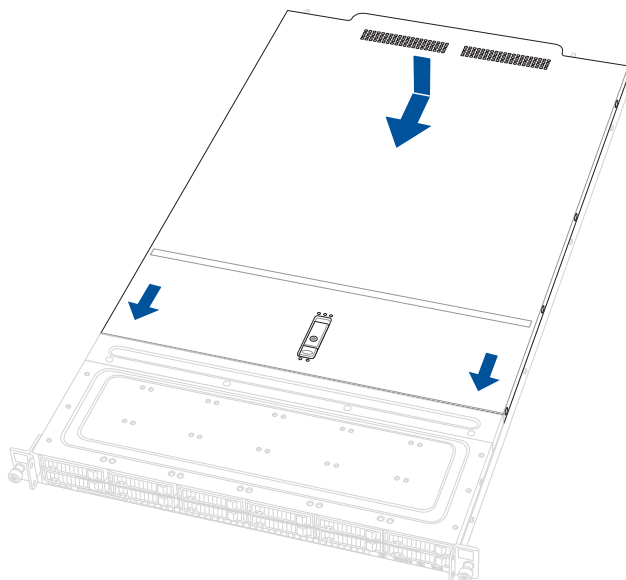

2. Push the latch downwards to lock the chassis cover into place.

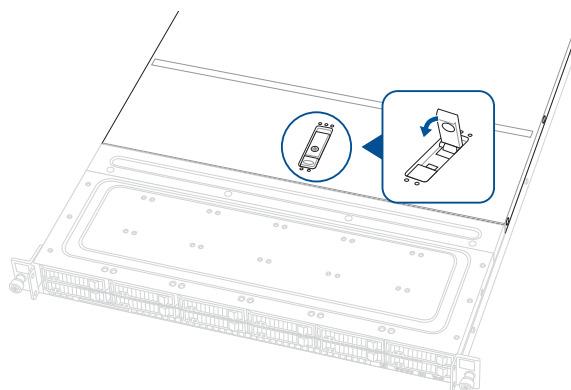

3. Turn the screw counter-clockwise to lock the latch.

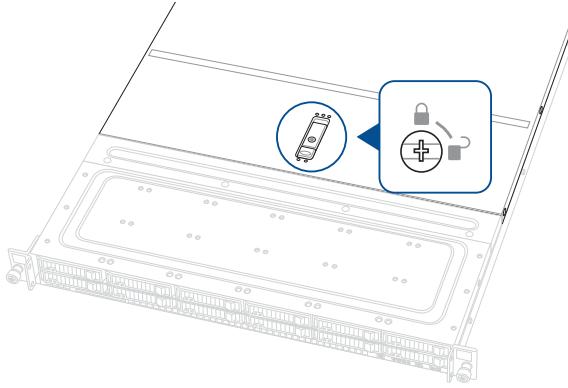

## 2.2 Air duct

### 2.2.1 Removing the air duct

Lift and remove the air duct.

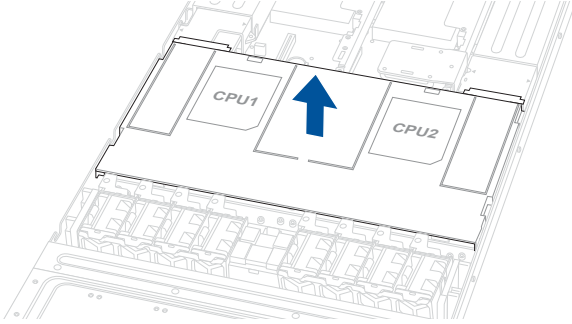

### 2.2.2 Installing the air duct

Install the air duct.

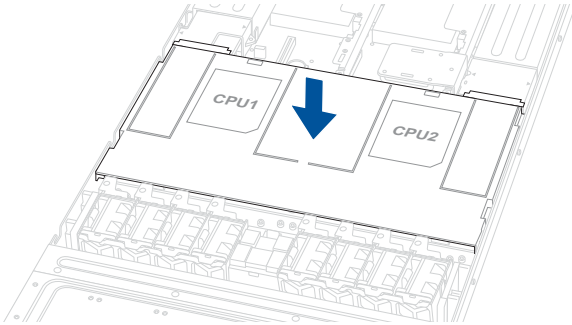

## 2.3 Central Processing Unit (CPU)

The motherboard comes with two surface mount Socket SP5 sockets designed for AMD EPYC™ 9005 series processors.

### CAUTION:

- Upon purchase of the motherboard, ensure that the PnP cap is on the socket and the socket contacts are not bent. Contact your retailer immediately if the PnP cap is missing, or if you see any damage to the PnP cap/socket contacts/motherboard components. ASUS will shoulder the cost of repair only if the damage is shipment/transit-related.
- Keep the cap after installing the motherboard. ASUS will process Return Merchandise Authorization (RMA) requests only if the motherboard comes with the cap on the socket.
- The product warranty does not cover damage to the socket contacts resulting from incorrect CPU installation/removal, or misplacement/loss/incorrect removal of the PnP cap.

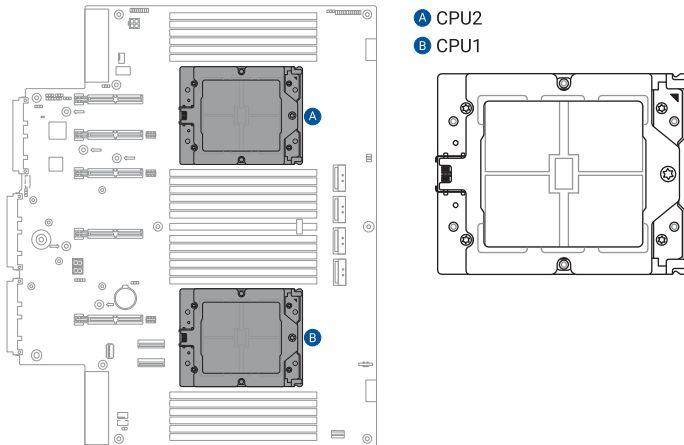

## 2.3.1 Installing the CPU and heatsink

**NOTE:**

- A T20 screwdriver with a torque value of  $13.5\pm 1.0$  kgf-cm is recommended.
- When securing the heatsink, partially tighten each of the six screws just enough to attach the heatsink to the motherboard. After all six screws are partially tightened, fully tighten each screw one by one.
- To remove this component, follow the instructions in reverse order.

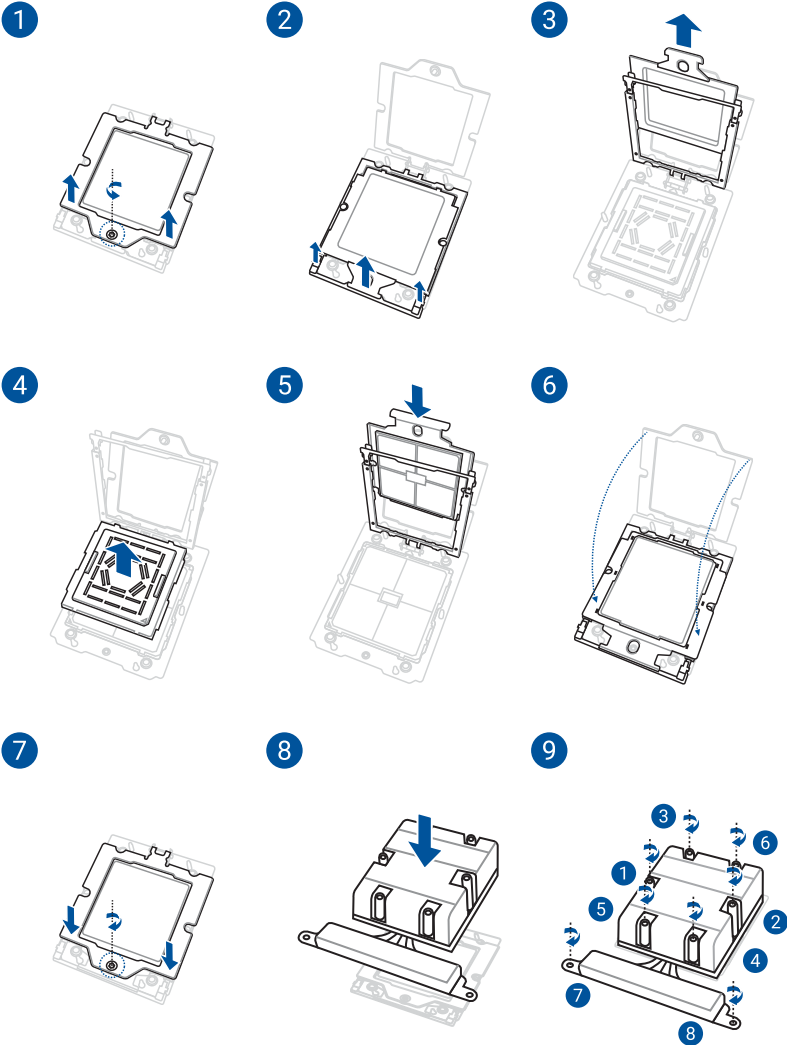

## 2.4 System memory

The motherboard comes with twenty four (24) Double Data Rate 5 (DDR5) Dual Inline Memory Modules (DIMM) sockets.

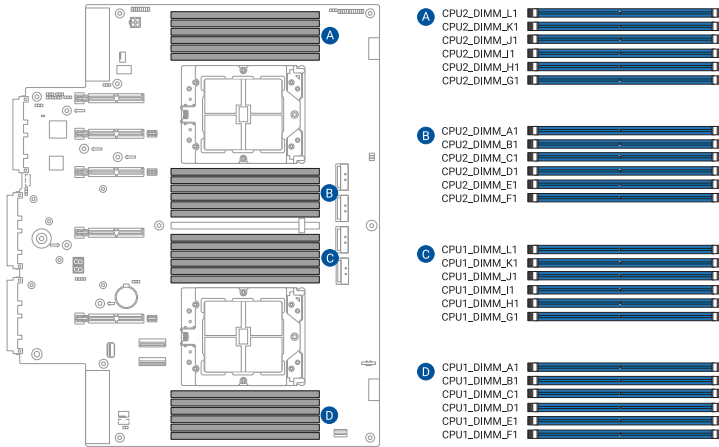

### 2.4.1 Memory configurations

**NOTE:**

- Refer to ASUS Server AVL for the updated list of compatible DIMMs.
- Always install DIMMs with the same CAS latency. For optimum compatibility, it is recommended that you obtain memory modules from the same vendor.

Recommended dual CPU configuration							
	2 DIMMs	4 DIMMs	8 DIMMs	12 DIMMs	16 DIMMs	20 DIMMs	24 DIMMs
CPU1/CPU2 A1	•	•	•	•	•	•	•
CPU1/CPU2 B1				•	•	•	•
CPU1/CPU2 C1			•	•	•	•	•
CPU1/CPU2 D1						•	•
CPU1/CPU2 E1					•	•	•
CPU1/CPU2 F1							•
CPU1/CPU2 G1		•	•	•	•	•	•
CPU1/CPU2 H1				•	•	•	•
CPU1/CPU2 I1			•	•	•	•	•
CPU1/CPU2 J1						•	•
CPU1/CPU2 K1					•	•	•
CPU1/CPU2 L1							•

## 2.4.2 Installing a DIMM

**NOTE:** A DIMM is keyed with a notch so that it fits in only one direction. DO NOT force a DIMM into a socket in the wrong direction to avoid damaging the DIMM.

**CAUTION:** Always insert the DIMM into the socket vertically to prevent DIMM notch damage.

1

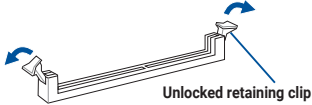

2

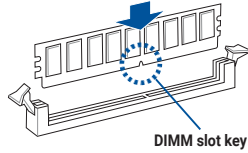

3

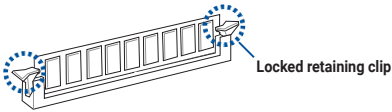

## 2.4.3 Removing a DIMM

**NOTE:** Support the DIMM lightly with your fingers when pressing the retaining clips. The DIMM might get damaged when it springs out with extra force.

1

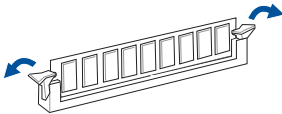

2

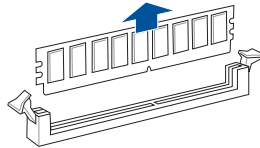



## 2.5 Front bezel (optional)

For extra security, a front bezel (purchased separately) can be installed to prevent unauthorized physical access to the hard drives and power button.

---

**NOTE:** To remove this component, follow the instructions in reverse order.

---

### 2.5.1 Removing the front bezel

1. Push the bezel release latch towards the right.



2. Pull the left side of the bezel to detach it from the chassis.

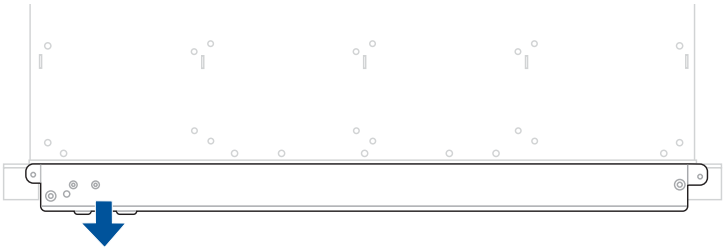

3. Slide the bezel towards the left and remove it from the chassis.

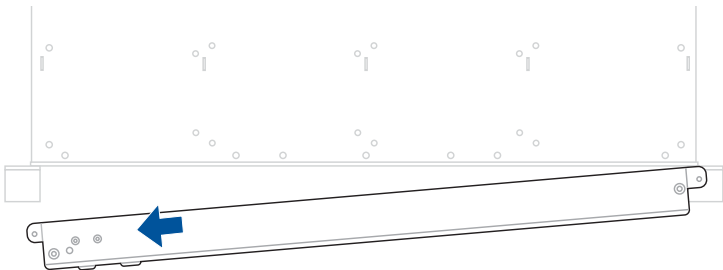

# 2.6 Storage devices

## RS700A-E13-RS4U

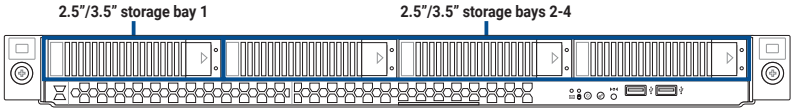

## RS700A-E13-RS12U

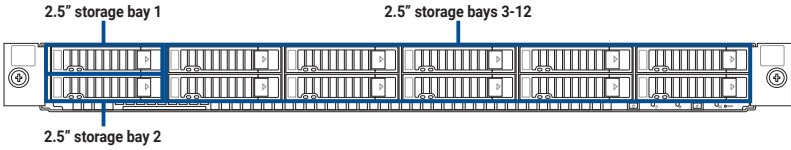

### 2.6.1 Installing a 2.5" storage device

**NOTE:** To remove this component, follow the instructions in reverse order.

#### 2.5" storage bays

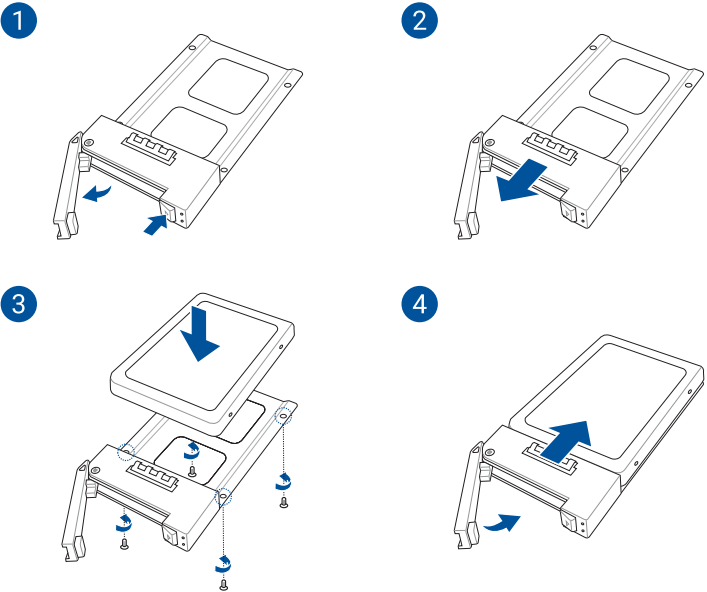

## 2.5"/3.5" storage bays

1

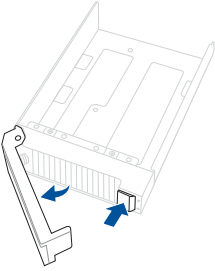

2

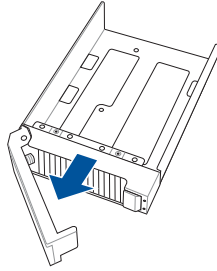

3

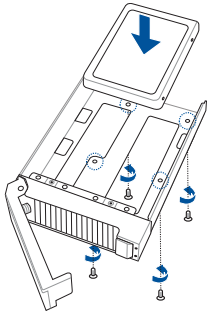

4

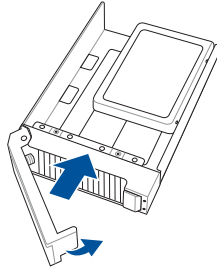

## 2.6.2 Installing a 3.5" storage device (on selected models)

---

**NOTE:** To remove this component, follow the instructions in reverse order.

---

### 2.5"/3.5" storage bays

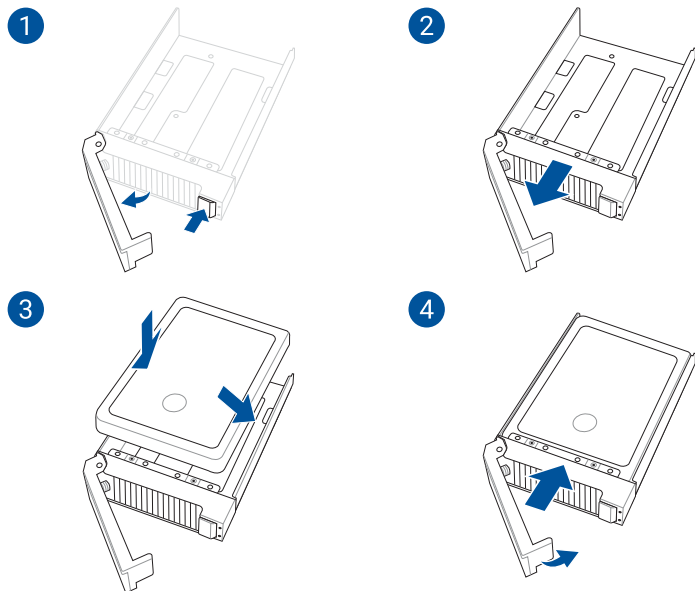

## 2.6.3 Installing an M.2 SSD module

**NOTE:**

- To remove this component, follow the instructions in reverse order.
- To install M.2 SSD modules of different lengths, remove the pre-installed standoff screw and install it in a different position.

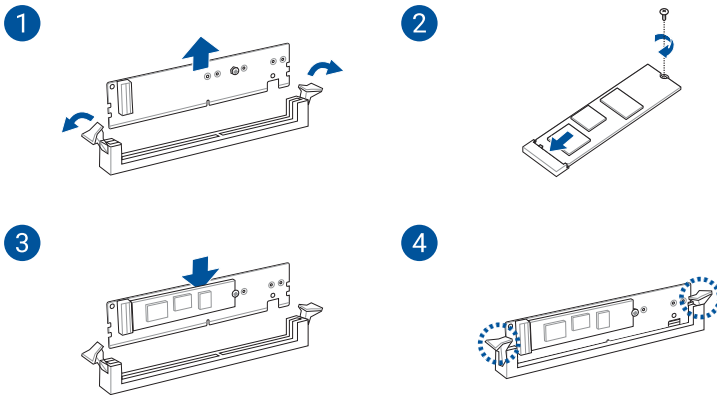
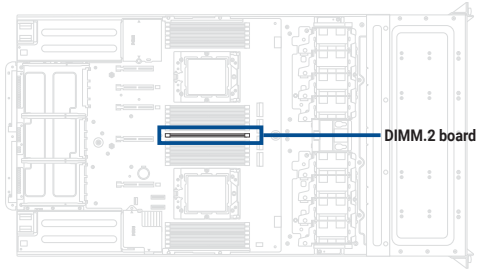

## 2.7 Expansion card brackets

### 2.7.1 Removing the expansion card brackets

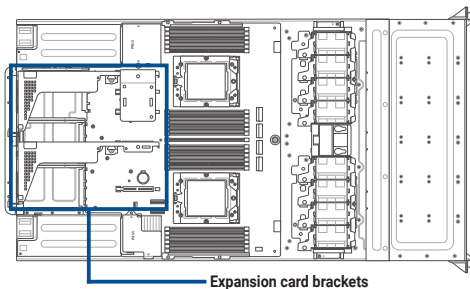

1. Loosen the thumbscrew.

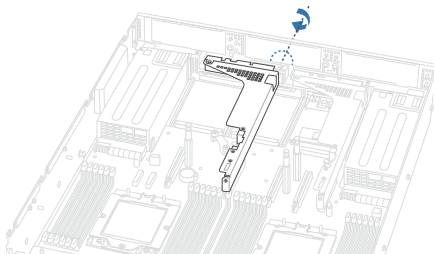

2. Press the latch inwards, then lift and remove the expansion card bracket.

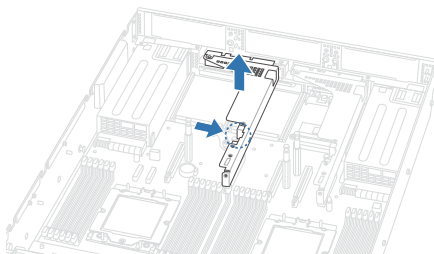

## 2.8 Expansion slots

**WARNING:** Unplug the power cord before adding or removing expansion cards. Failure to do so may cause you physical injury and damage motherboard components.

**NOTE:**

- Before installing an expansion card, read the documentation that came with it and ensure that the proper hardware settings are configured.
- To remove this component, follow the instructions in reverse order.

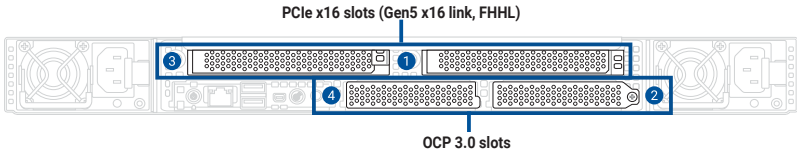

#	PCIe link	BIOS identifier	Slot interface	Operating mode
1	Gen5 x16 link	S0P2	MXI02-X16	Gen5 x16 link
2	Gen5 x16 link	S0P3	CPU1-OCP	Gen5 x16 link
3	Gen5 x16 link	S1P2	MXI05-X16	Gen5 x16 link
4	Gen5 x16 link	S1P1	CPU2-OCP	Gen5 x16 link

## 2.8.1 Installing a PCIe expansion card

1. Remove the following components:
  - Chassis cover
  - Air duct
  - Upper expansion card brackets
2. Push the slot cover lock outwards, then remove the PCIe slot cover.

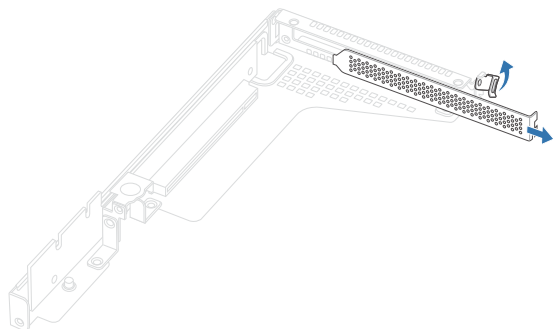

3. Install the expansion card, then push the slot cover lock inwards to secure the expansion card.

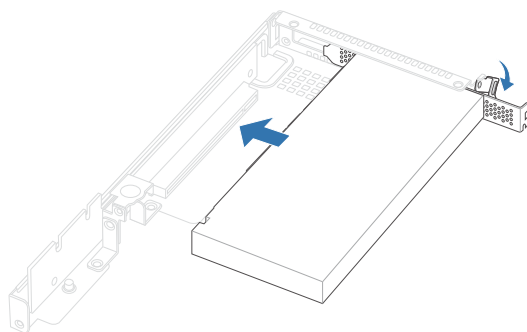



4. Install the expansion card bracket and tighten the thumbscrew.

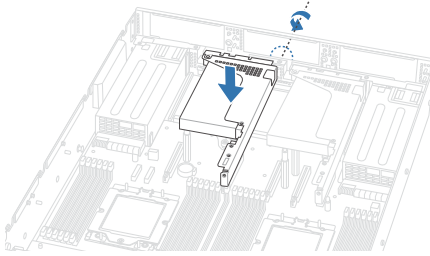

## 2.8.2 Installing an HBA/RAID card

1. Refer to the **Installing a PCIe expansion card** section to install the HBA/RAID card.
2. Connect the HBA/RAID card to the storage device backplane.
3. To install a cache vault power module, refer to the **Installing a cache vault power module** section (optional).

## 2.8.3 Installing a cache vault power module (optional)

1. Partially fasten the three nuts onto the expansion card bracket.

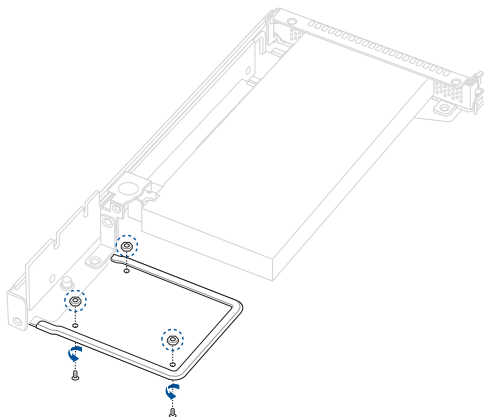

2. Install the cache vault power module clip onto the air duct, then fully tighten the screws.

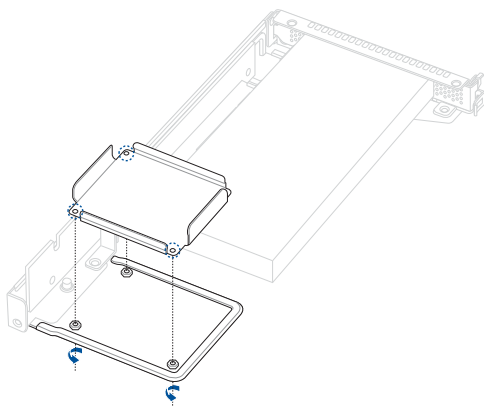

3. Install the cache vault power module, then connect the cache vault power module to the HBA/RAID card.

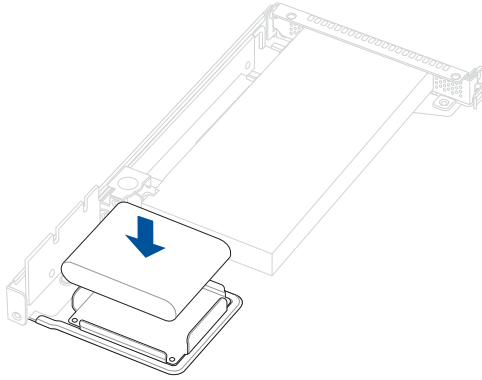

## 2.8.4 Installing an OCP card

### OCP 3.0 slots

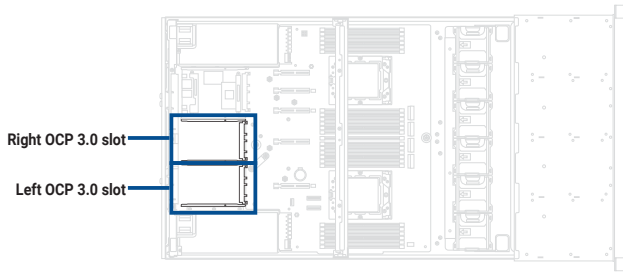

### Left OCP 3.0 slot

1. Remove the following components:
  - Chassis cover
  - Air duct
  - Expansion card brackets
2. Remove the screw, then remove the OCP slot cover.

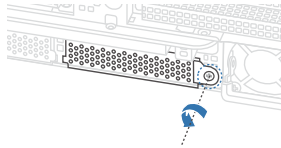

3. Install the OCP card.

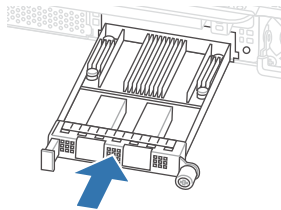

## Right OCP 3.0 slot

1. Remove the following components:
  - Chassis cover
  - Air duct
  - Expansion card brackets
2. Remove the screws, then remove the OCP slot cover.

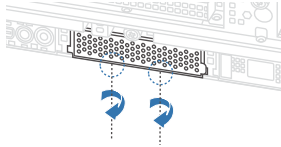

3. Install the OCP card.

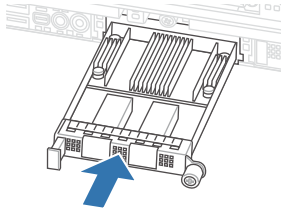

# 2.9 Cable connections

**NOTE:**

- The bundled system cables are pre-connected before shipment. You do not need to disconnect these cables unless you are going to remove pre-installed components to install additional devices.
- Refer to the **Motherboard Information** chapter for detailed information on the connectors.

## Board locations

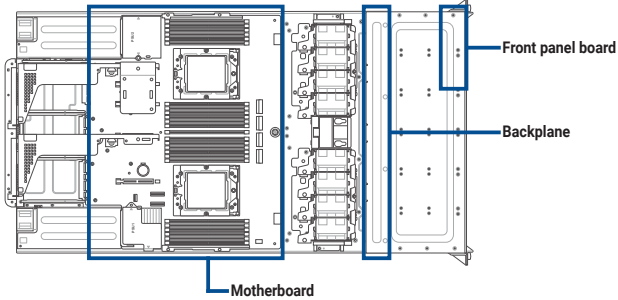

## Motherboard connector locations

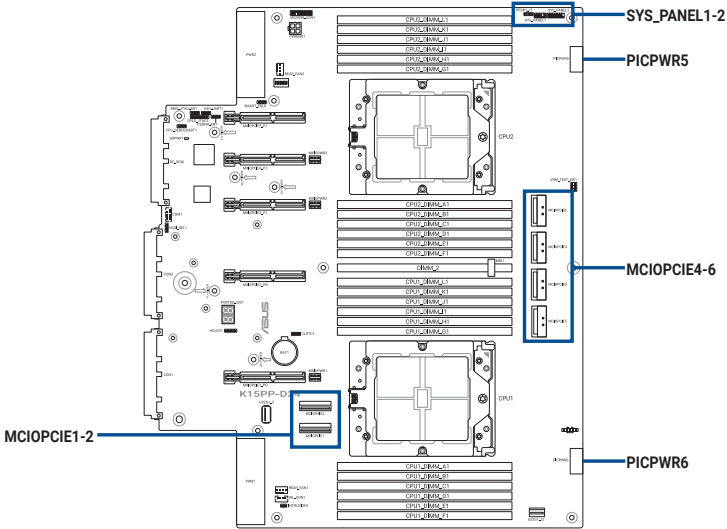

## 2.9.1 Pre-connected system cables

### RS700A-E13-RS4U (4x NVMe/SATA)

2.5"/3.5" storage bays 1-4 (NVMe/SATA)

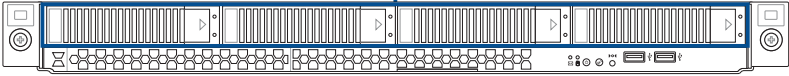

Connect from		Connect to	
Connector	Location	Connector	Location
MCIOPCIE1	Motherboard	SLIMSAS1	Backplane
MCIOPCIE3	Motherboard	MCIO_P2	Backplane
MCIOPCIE5	Motherboard	MCIO_P1	Backplane
PICPWR5	Motherboard	PWR1	Backplane
U32G1_12	Motherboard	USB3_HD1	Front panel board
SYS_PANEL1	Motherboard	FPB_CON1	Front panel board
SYS_PANEL2	Motherboard	LAN34_CON1	Front panel board

## RS700A-E13-RS12U (SKU1: 12x NVMe)



Connect from		Connect to	
Connector	Location	Connector	Location
MCIOPCIE1	Motherboard	MCIO_P1	Backplane
MCIOPCIE2	Motherboard	MCIO_P2	Backplane
MCIOPCIE3	Motherboard	MCIO_P4	Backplane
MCIOPCIE4	Motherboard	MCIO_P5	Backplane
MCIOPCIE5	Motherboard	MCIO_P3	Backplane
MCIOPCIE6	Motherboard	MCIO_P6	Backplane
PICPWR5	Motherboard	PWR1	Backplane
SYS_PANEL1	Motherboard	FPB_CON1	Front panel board
SYS_PANEL2	Motherboard	FPB_CON1	Front panel board

## RS700A-E13-RS12U (SKU2: 8x NVMe/SATA + 4x SATA)

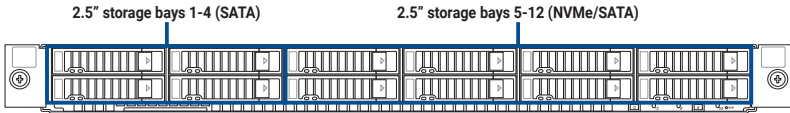

Connect from		Connect to	
Connector	Location	Connector	Location
MCIOPCIE1	Motherboard	SLIMSAS1, SLIMSAS2	Backplane
MCIOPCIE2	Motherboard	SLIMSAS3	Backplane
MCIOPCIE3	Motherboard	MCIO_P4	Backplane
MCIOPCIE4	Motherboard	MCIO_P5	Backplane
MCIOPCIE5	Motherboard	MCIO_P3	Backplane
MCIOPCIE6	Motherboard	MCIO_P6	Backplane
PICPWR5	Motherboard	PWR1	Backplane
SYS_PANEL1	Motherboard	FPB_CON1	Front panel board
SYS_PANEL2	Motherboard	FPB_CON1	Front panel board



## 2.9.2 Storage device configurations and cabling

### RS700A-E13-RS4U (4x NVMe/SATA)

#### RAID for NVMe (bays 1-4)

Connect from		Connect to	
Connector	Location	Connector	Location
C0	RAID card	MCI0_P1	Backplane
C1	RAID card	MCI0_P2	Backplane

#### RAID for SATA/SAS (bays 1-4)

Connect from		Connect to	
Connector	Location	Connector	Location
MCI0PCIE3	Motherboard	MCI0_P2	Backplane
MCI0PCIE5	Motherboard	MCI0_P1	Backplane
C0	RAID card	SLIMSAS1	Backplane

### RS700A-E13-RS12U (SKU1: 12x NVMe)

#### RAID for NVMe (bays 1-4)

Connect from		Connect to	
Connector	Location	Connector	Location
MCI0PCIE3	Motherboard	MCI0_P4	Backplane
MCI0PCIE4	Motherboard	MCI0_P5	Backplane
MCI0PCIE5	Motherboard	MCI0_P3	Backplane
MCI0PCIE6	Motherboard	MCI0_P6	Backplane
C0	RAID card	MCI0_P1	Backplane
C1	RAID card	MCI0_P2	Backplane

### RS700A-E13-RS12U (SKU2: 8x NVMe/SATA + 4x SATA)

#### RAID for SATA/SAS (bays 1-12)

Connect from		Connect to	
Connector	Location	Connector	Location
MCI0PCIE3	Motherboard	MCI0_P4	Backplane
MCI0PCIE4	Motherboard	MCI0_P5	Backplane
MCI0PCIE5	Motherboard	MCI0_P3	Backplane
MCI0PCIE6	Motherboard	MCI0_P6	Backplane
C0	RAID card	SLIMSAS1, SLIMSAS2	Backplane
C1	RAID card	SLIMSAS3	Backplane

## 2.10 System fans

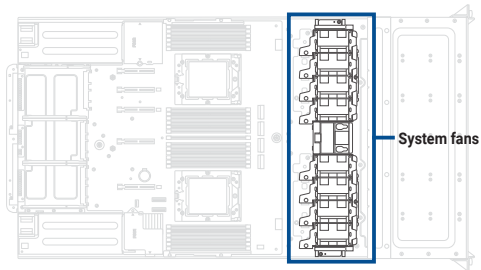

### 2.10.1 Removing a system fan

Press the latch inwards, then pull and remove the fan from the fan cage.

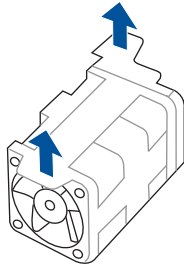

### 2.10.2 Installing a system fan

Install the fan into the fan cage and ensure it is securely seated.

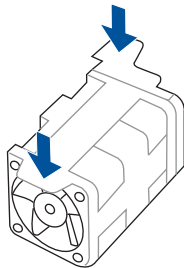

## 2.11 Redundant power supply units

### NOTE:

- The system automatically combines the power supply units. The combined output power varies with input voltages.
- To enable the hot-swap feature (redundant mode), keep the total power consumption of the system under the maximum output power of an individual power supply module.

### WARNING:

- Always use PSUs with the same watt and power rating. Combining PSUs with different wattages may yield unstable results and potential damage to your system.
- For a steady power input, use only the power cables that come with the server system package.

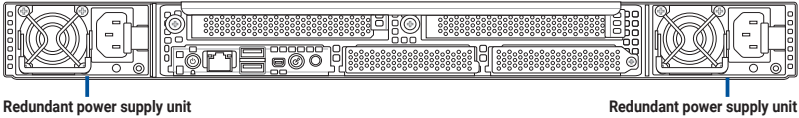

### 2.11.1 Removing a power supply unit

1. Lift up the PSU lever.

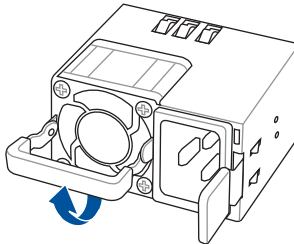

2. Hold the PSU lever and press the PSU latch inwards, then carefully pull the PSU out of the system chassis.

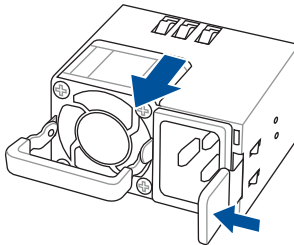

## 2.11.2 Installing a power supply unit

Align and install the PSU into the server chassis until it clicks into place.

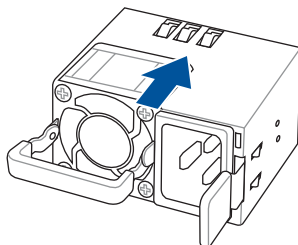

## 2.12 Motherboard

### 2.12.1 Removing the motherboard

To remove the system motherboard:

1. Disconnect the cables from the motherboard and remove any installed components on the motherboard.

---

**NOTE:** Take a photo or make a note of which components are removed, which cables are disconnected, and which connectors the cables were connected to.

---

2. Remove the screws, then remove the motherboard.

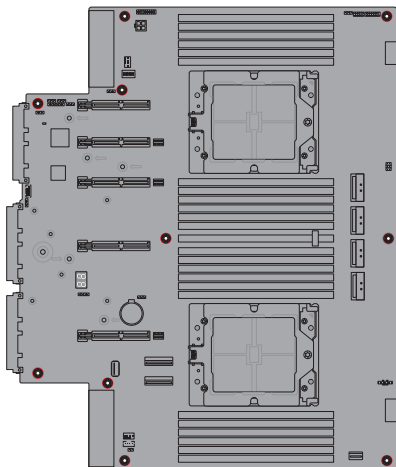

## 2.12.2 Installing the motherboard

To install the system motherboard:

1. Place the motherboard into the chassis and ensure the screw holes on the motherboard are aligned with the screw holes in the chassis, then secure the motherboard to the chassis using the screws removed previously.

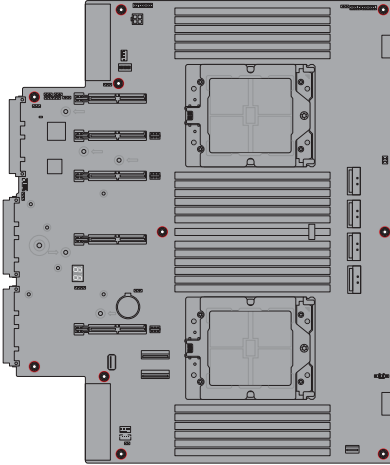

2. Reinstall any removed components and reconnect the cables to the motherboard.

## 2.13 CMOS battery

### 2.13.1 Replacing the CMOS battery

1. Remove the CMOS battery.

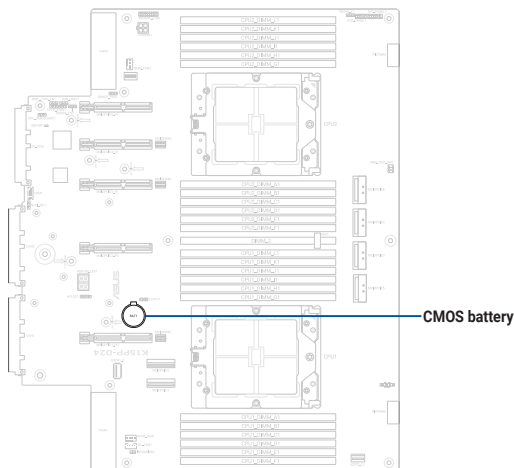

2. Place the replacement CMOS battery into the battery compartment.

## 2.14 Rail kit options

This server system supports the rail kit options listed below. For more information on rail kit installation, refer to corresponding documentation on the ASUS support site or on the official product site for this server system.

---

#### NOTE:

- We strongly recommend that at least two able-bodied persons perform the installation of the rail kit.
  - We recommend the use of an appropriate lifting tool or device, if necessary.
- 
- 1U full-pull ball bearing rail kit

# Motherboard Information

This chapter includes the motherboard layout and brief descriptions of the jumpers and internal connectors.



# 3.1 Motherboard layout

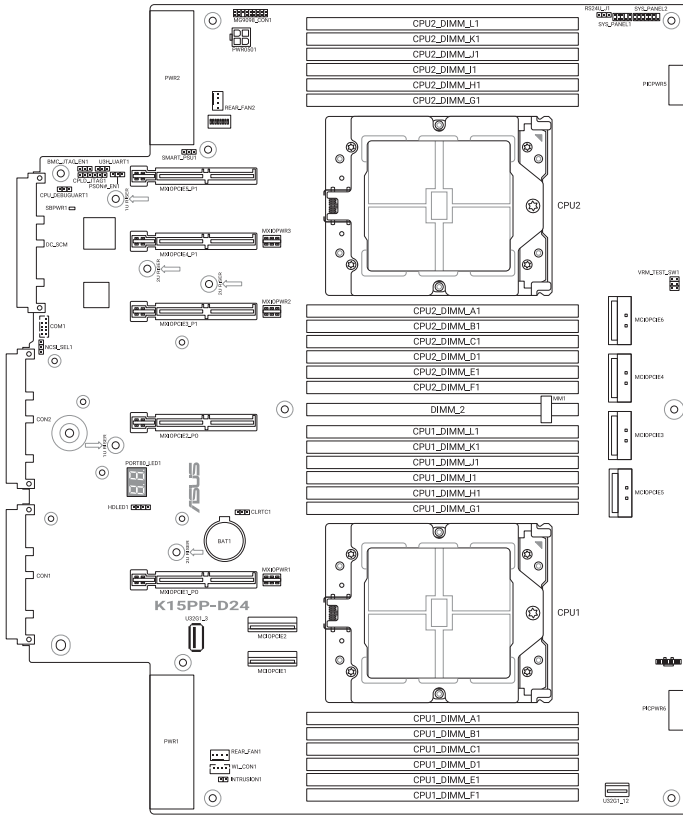



## Layout contents

Sockets/slots	Page
1. CPU sockets (CPU1-2)	3-4
2. DIMM sockets (CPU1/CPU2_DIMM_A1-L1)	3-4
3. DIMM2 socket (DIMM.2)	3-5

Jumpers	Page
1. Clear RTC RAM (3-pin CLRTC1)	3-6
2. NCSI setting (3-pin NCSI_SEL1)	3-7
3. Smart Ride Through (SmART) setting (3-pin SMART_PSU1)	3-7

Onboard LEDs	Page
1. Q-Code LED (PORT80_LED1)	3-8
2. Standby power LED (SBPWR1)	3-8

Internal connectors	Page
1. Serial port connector (10-1 pin COM1)	3-9
2. CPLD JTAG connector (6-pin CPLD_JTAG1)	3-9
3. Chassis intrusion connector (2-pin INTRUSION1)	3-10
4. MCIOPCIE connector (MCIOPCIE1-6)	3-10
5. Power connector (PWR1-2)	3-11
6. System panel connector (10-1 pin SYS_PANEL1; 14-1 pin SYS_PANEL2)	3-12
7. USB 5Gbps connector (U32G1_12; U32G1_3)	3-13

## 3.2 Sockets

### 1. CPU sockets (CPU1-2)

The motherboard comes with two surface mount Socket SP5 sockets designed for AMD EPYC™ 9005 series processors.

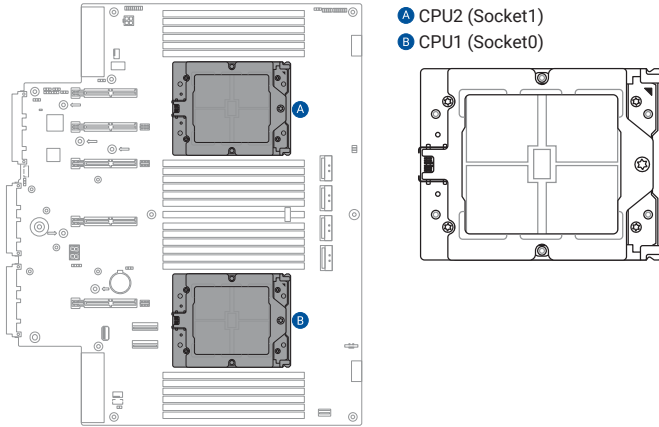

### 2. Dual Inline Memory Module (DIMM) sockets (CPU1/CPU2\_DIMM\_A1-L1)

The motherboard comes with twenty four (24) Double Data Rate 5 (DDR5) Dual Inline Memory Modules (DIMM) sockets.

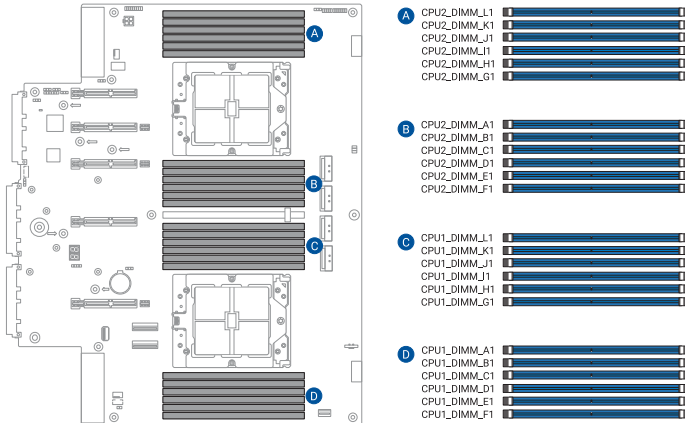

### 3. DIMM.2 socket (DIMM.2)

This socket is designed for the DIMM.2 M.2 board.

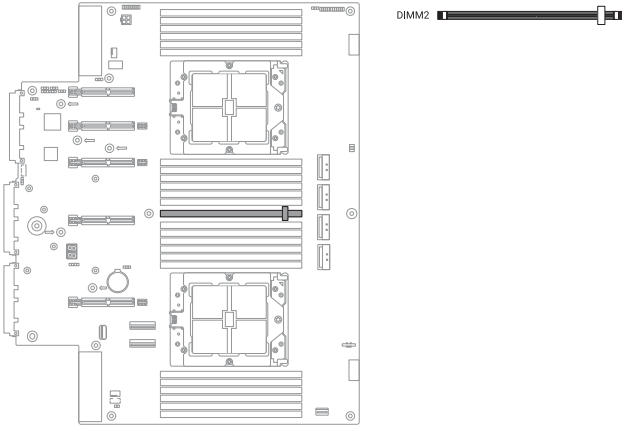

# 3.3 Jumpers

## 1. Clear RTC RAM (3-pin CLRTC1)

This jumper allows you to clear the Real Time Clock (RTC) RAM in CMOS. You can clear the CMOS memory of date, time, and system setup parameters by erasing the CMOS RTC RAM data. The onboard button cell battery powers the RAM data in CMOS, which include system setup information such as system passwords.

To erase the RTC RAM:

1. Turn OFF the computer and disconnect the power cord.
2. Move the jumper cap from pins 1-2 (default) to pins 2-3. Keep the cap on pins 2-3 for about 5-10 seconds, then move the cap back to pins 1-2.
3. Reconnect the power cord and turn ON the computer.
4. Hold down the <Del> key during the boot process to enter the BIOS setup and reconfigure system setup parameters.

---

**CAUTION:** Except when clearing the RTC RAM, never remove the cap in the default position on the CLRTC jumper. Removing the cap will cause system boot failure!

---

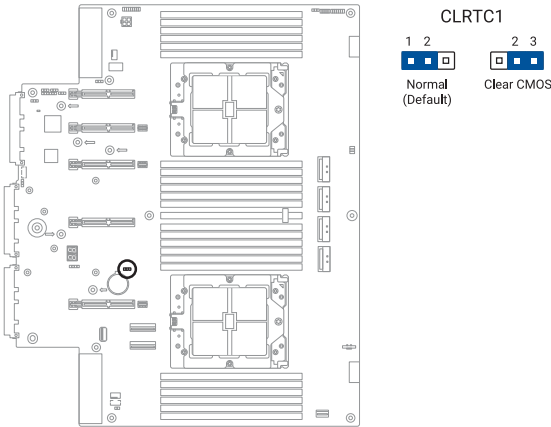

## 2. NCSI setting (3-pin NCSI\_SEL1)

This jumper allows you to select the NCSI device.

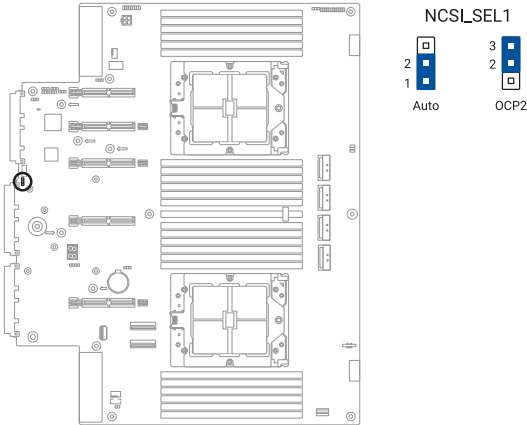

## 3. Smart Ride Through (SmaRT) setting (3-pin SMART\_PSU1)

This jumper allows you to enable or disable the Smart Ride Through (SmaRT) function. This feature is enabled by default. Set to pins 2-3 to disable it. When enabled, SmaRT allows uninterrupted operation of the system during an AC loss event.

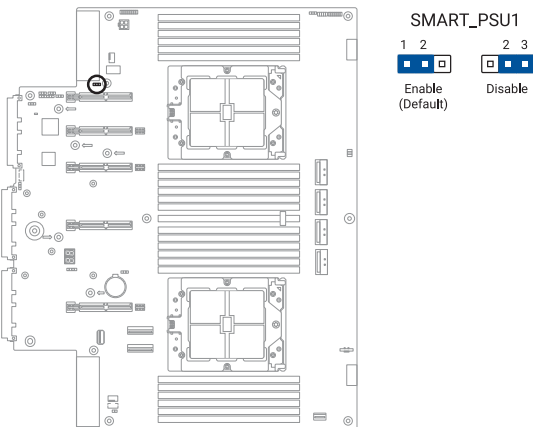

### 3.4 Internal LEDs

#### 1. Q-Code LED (PORT80\_LED1)

The Q-Code LED displays a 2-digit error code that indicates the system status.

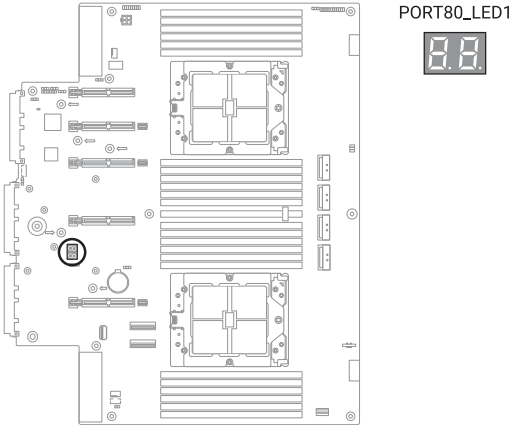

#### 2. Standby power LED (SBPWR1)

The standby power LED lights up to indicate that the system is ON, in sleep mode, or in soft-off mode. This is a reminder that you should shut down the system and unplug the power cable before removing or plugging in any motherboard component.

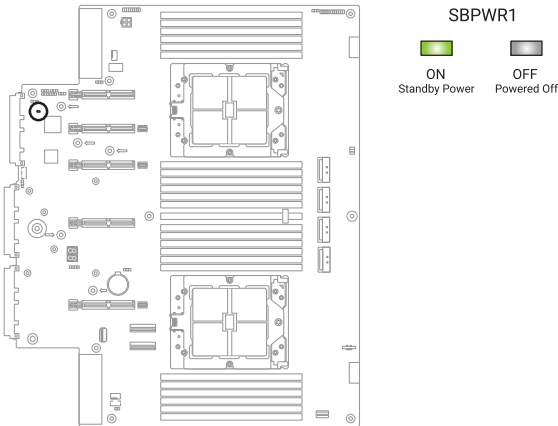

## 3.5 Internal connectors

### 1. Serial port connector (10-1 pin COM1)

This connector is for a serial (COM) port. Connect the serial port module cable to this connector, then install the module to a slot opening at the back of the system chassis.

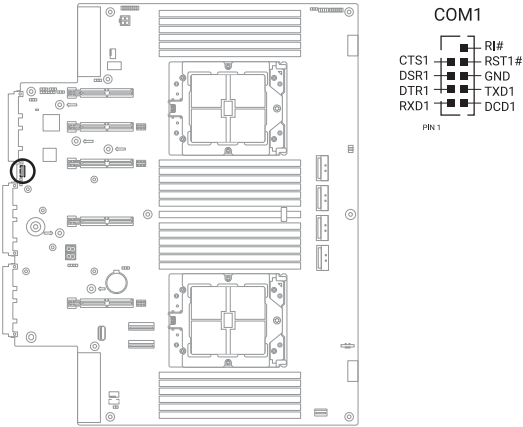

### 2. CPLD JTAG connector (6-pin CPLD\_JTAG1)

This connector is used for burning the CPLD JTAG.

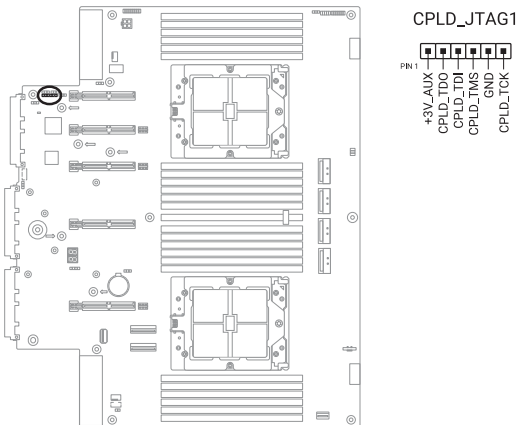

**3. Chassis intrusion connector (2-pin INTRUSION1)**

This connector is for a chassis-mounted intrusion detection sensor or switch. Connect one end of the chassis intrusion sensor or switch cable to this connector. The chassis intrusion sensor or switch sends a high-level signal to this connector when a chassis component is removed or replaced. The signal is then generated as a chassis intrusion event.

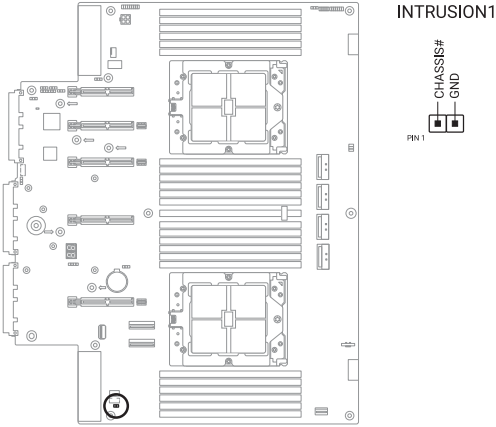

**4. MCIOPCIE connector (MCIOPCIE1-6)**

This connector connects the PCIe signal to the backplane.

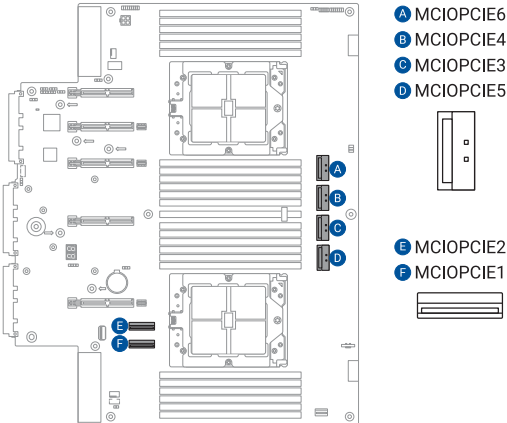



## 5. Power connector (PWR1-2)

This connector connects to the power supply units and supplies power to the motherboard.

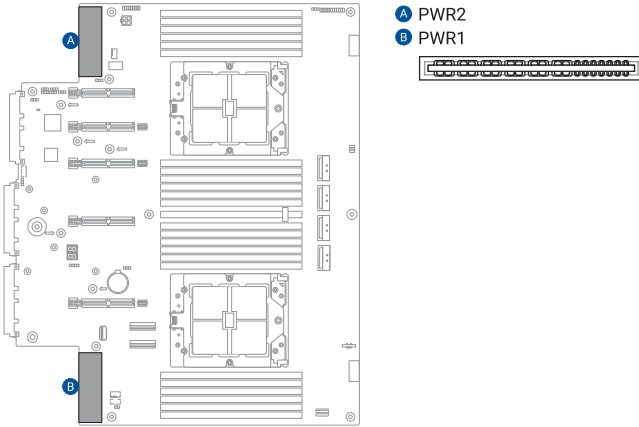

**6. System panel connector (10-1 pin SYS\_PANEL1; 14-1 pin SYS\_PANEL2)**

This connector supports several chassis-mounted functions.

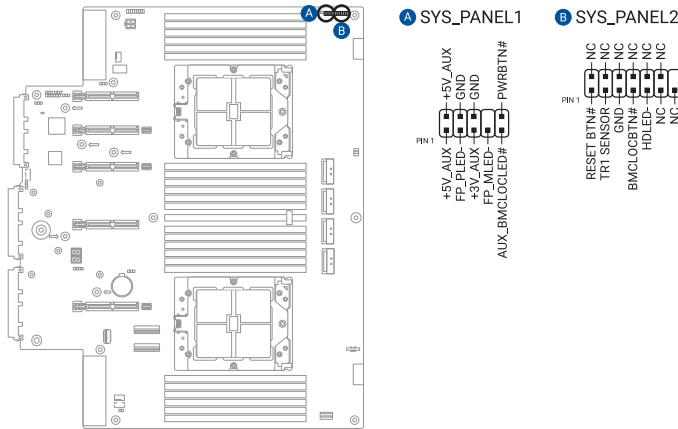

- System power LED (FP\_PLED)**

This 1-pin connector is for the system power LED. Connect the chassis power LED cable to this connector. The system power LED lights up when you turn on the system power.
- Message LED (FP\_MLED)**

This 2-pin connector is for the message LED cable that connects to the front message LED. The message LED is controlled by the BMC to indicate an abnormal event occurrence.
- Locator LED connector (AUX\_BMCLOCCLED)**

This connector allows you to connect the Locator LED. The Location LED helps visually locate and identify the server in error on a server rack.
- Power Button/Soft-off Button connector (PWRBTN)**

The 3-1 pin connector allows you to connect the system power button. Press the power button to power up the system, or put the system into sleep or soft-off mode (depending on the operating system settings).
- Reset button connector (RESETBTN)**

This connector allows you to connect the chassis-mounted reset button. Press the reset button to reboot the system.
- TR1 Sensor connector (TR1\_SENSOR)**

This connector allows detection of the environmental temperature of the front panel.
- Locator button connector (BMCLOCBTN#)**

This connector allows you to connect the Locator button. Press the button to light up the Locator LED.

**7. USB 5Gbps connector (U32G1\_12; U32G1\_3)**

This connector allows you to connect a USB 5Gbps module for additional USB 5Gbps ports on the front panel. The Type-A connector allows you to directly connect a USB flash drive.

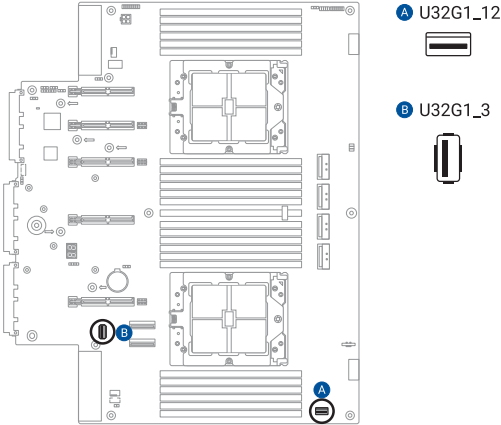



# BIOS Setup

# 4

This chapter tells how to change the system settings through the BIOS Setup menus. Detailed descriptions of the BIOS parameters are also provided.

## 4.1 Managing and updating your BIOS

The following utilities allow you to manage and update the motherboard Basic Input/Output System (BIOS) setup:

1. **ASUS CrashFree BIOS 3**

To recover the BIOS using a bootable USB flash disk drive if the BIOS file fails or gets corrupted.

2. **ASUS EzFlash**

Updates the BIOS using a USB flash disk.

Refer to the corresponding sections for details on these utilities.

### 4.1.1 ASUS CrashFree BIOS 3 Utility

The ASUS CrashFree BIOS 3 is an auto recovery tool that allows you to restore the BIOS file if it fails or gets corrupted during the updating process. You can update a corrupted BIOS file using a USB flash drive that contains the updated BIOS file.

---

**NOTE:** Prepare a USB flash drive containing the updated motherboard BIOS before using this utility.

---

#### Recovering the BIOS from a USB flash drive

To recover the BIOS from a USB flash drive:

1. Insert the USB flash drive with the original or updated BIOS file to one USB port on the system.
2. The utility will automatically recover the BIOS. It resets the system when the BIOS recovery finished.

---

**CAUTION:** DO NOT shut down or reset the system while recovering the BIOS! Doing so would cause system boot failure!

---

**NOTE:** The recovered BIOS may not be the latest BIOS version for this motherboard. Visit the ASUS website at [www.asus.com](http://www.asus.com) to download the latest BIOS file.

---

## 4.1.2 ASUS EZ Flash Utility

The ASUS EZ Flash Utility feature allows you to update the BIOS without having to use a DOS-based utility.

---

**NOTE:** Before you start using this utility, download the latest BIOS from the ASUS website at [www.asus.com](http://www.asus.com).

---

To update the BIOS using EZ Flash Utility:

1. Insert the USB flash disk that contains the latest BIOS file into the USB port.
2. Enter the BIOS setup program. Go to the **Tool** menu, then select **Start ASUS EZ Flash**. Press <Enter>.

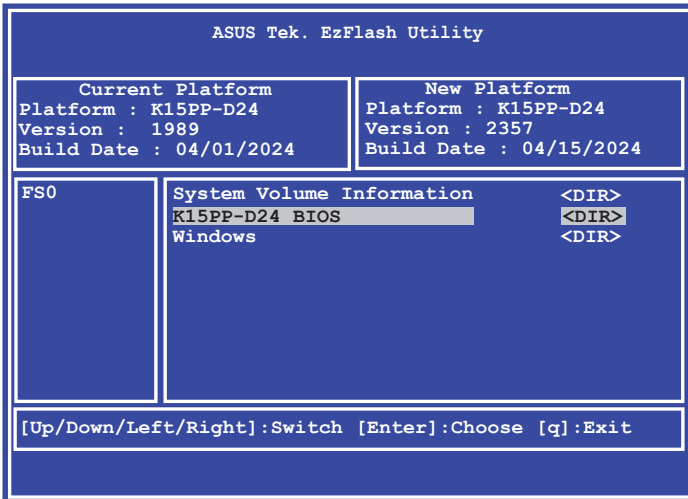

3. Press the Left/Right arrow keys to switch to the **Drive** field.
4. Press the Up/Down arrow keys to find the USB flash disk that contains the latest BIOS, then press <Enter>.
5. Press Left/Right arrow keys to switch to the **Folder Info** field.
6. Press the Up/Down arrow keys to find the BIOS file, then press <Enter> to perform the BIOS update process. Reboot the system when the update process is done.

---

**CAUTION:**

- This function can support devices such as a USB flash disk with FAT 32/16 format and single partition only.
  - DO NOT shut down or reset the system while updating the BIOS to prevent system boot failure!
- 

**NOTE:** Use the default BIOS settings to ensure system compatibility and stability. Press <F5> and select **Yes** to load the default BIOS settings.

---

## 4.2 BIOS setup program

This motherboard supports a programmable firmware chip that you can update using the provided utility described in the **Managing and updating your BIOS** section.

Use the BIOS Setup program when you are installing a motherboard, reconfiguring your system, or prompted to "Run Setup." This section explains how to configure your system using this utility.

Even if you are not prompted to use the Setup program, you can change the configuration of your computer in the future. For example, you can enable the security password feature or change the power management settings. This requires you to reconfigure your system using the BIOS Setup program so that the computer can recognize these changes and record them in the CMOS RAM of the firmware chip.

The firmware chip on the motherboard stores the Setup utility. When you start up the computer, the system provides you with the opportunity to run this program. Press <Del> during the Power-On Self-Test (POST) to enter the Setup utility; otherwise, POST continues with its test routines.

If you wish to enter Setup after POST, restart the system by pressing <Ctrl>+<Alt>+<Delete>, or by pressing the reset button on the system chassis. You can also restart by turning the system off and then back on. Do this last option only if the first two failed.

The Setup program is designed to make it as easy to use as possible. Being a menu-driven program, it lets you scroll through the various sub-menus and make your selections from the available options using the navigation keys.

---

### NOTE:

- The default BIOS settings for this motherboard apply for most conditions to ensure optimum performance. If the system becomes unstable after changing any BIOS settings, load the default settings to ensure system compatibility and stability. Press <F5> and select **Yes** to load the BIOS default settings.
  - The BIOS setup screens shown in this section are for reference purposes only, and may not exactly match what you see on your screen.
  - Visit the ASUS website ([www.asus.com](http://www.asus.com)) to download the latest BIOS file for this motherboard.
-



## 4.2.1 BIOS menu screen

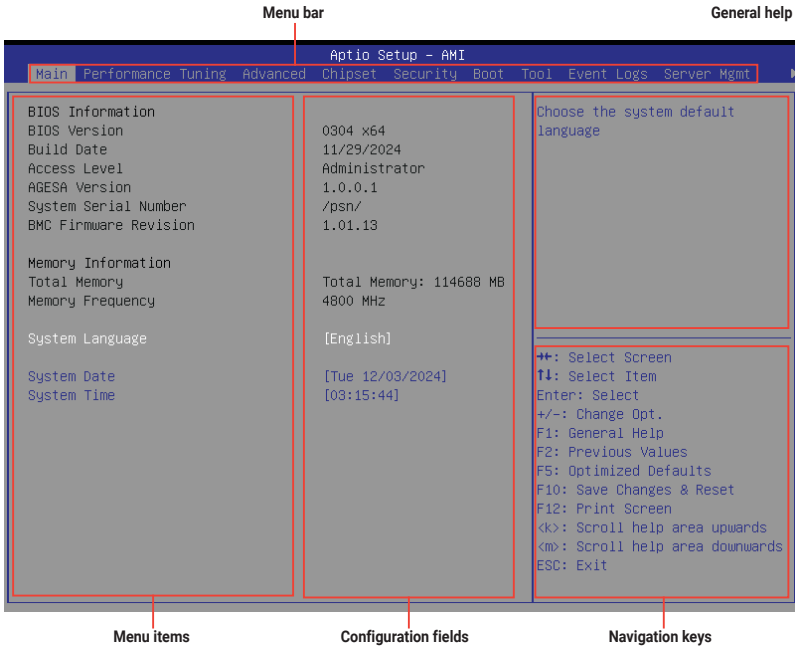

## 4.2.2 Menu bar

The menu bar on top of the screen has the following main items:

- Main** For changing the basic system configuration
- Advanced** For changing the advanced system settings
- Chipset** For changing the chipset settings
- Security** For changing the security settings
- Boot** For changing the system boot configuration
- Tool** For configuring options for special functions
- Event Logs** For changing the event log settings
- Server Mgmt** For changing the Server Mgmt settings
- Exit** For selecting the exit options

To select an item on the menu bar, press the right or left arrow key on the keyboard until the desired item is highlighted.

## Menu items

The highlighted item on the menu bar displays the specific items for that menu. For example, selecting **Main** shows the Main menu items.

The other items (such as **Advanced**) on the menu bar have their respective menu items.

## Submenu items

A solid triangle before each item on any menu screen means that the item has a submenu. To display the submenu, select the item then press <Enter>.

## Navigation keys

At the bottom right corner of a menu screen are the navigation keys for the BIOS setup program. Use the navigation keys to select items in the menu and change the settings.

## General help

At the top right corner of the menu screen is a brief description of the selected item.

## Configuration fields

These fields show the values for the menu items. If an item is user-configurable, you can change the value of the field opposite the item. You cannot select an item that is not user-configurable.

A configurable field is enclosed in brackets, and is highlighted when selected. To change the value of a field, select it and press <Enter> to display a list of options.

## Pop-up window

Select a menu item and press <Enter> to display a pop-up window with the configuration options for that item.

## Scroll bar

A scroll bar appears on the right side of a menu screen when there are items that do not fit on the screen. Press the Up/Down arrow keys or <Page Up> / <Page Down> keys to display the other items on the screen.

## 4.3 Main menu

When you enter the BIOS Setup program, the Main menu screen appears. The Main menu provides you an overview of the basic system information, and allows you to set the system date, time, and language settings.

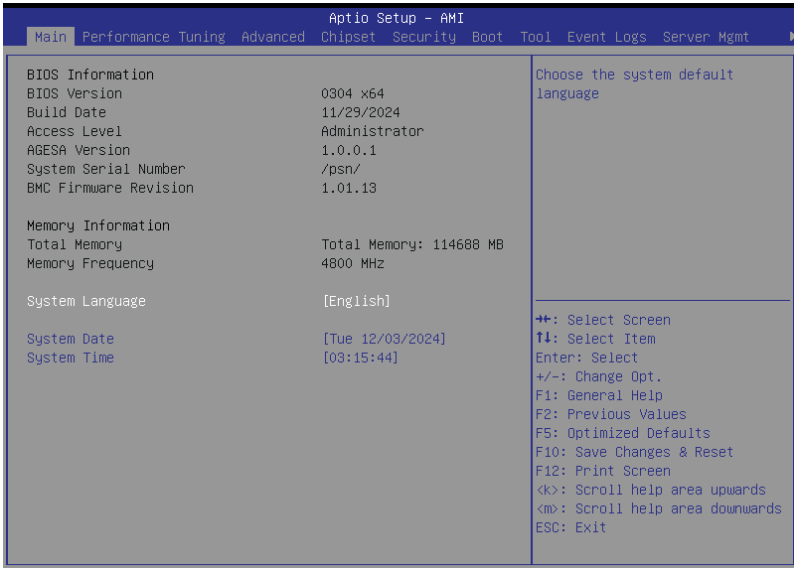

### System Language

Allows you to set the system language.

### System Date [MM/DD/YYYY]

Allows you to set the system date.

### System Time [HH:MM:SS]

Allows you to set the system time.

## 4.4 Performance Tuning menu

The Performance Tuning menu items allow you to change performance related settings for different scenarios.



### Optimized Performance Setting [Default]

Allows you to select performance settings for different scenarios.

[Default] Default settings.

[By Benchmark] Optimize for different kinds of benchmarks. Select this option, then select a benchmark type from the >> list.

[By Workload] Optimize for different kinds of workloads. Select this option, then select a workload type from the >> list.

---

**CAUTION:** This function will reset some BIOS settings that you have changed back to their default values. Please check your BIOS settings again.

---

**NOTE:** The following item appears only when **Power Balancer** is set to **[Disabled]**, or if **Optimized Performance Setting** is set to **[Default]** or **[By Benchmark]**.

---

### Core Optimizer [Disabled]

Allows you to keep the processor operating at the turbo highest frequency for the maximum performance.

Configuration options: [Disabled] [Auto] [Manual]

---

**NOTE:** The following item appears only when you set **Core Optimizer** to **[Manual]**.

---

### CPU Max frequency [XXXX]

The default value for this option will be the maximum supported frequency of the CPU installed and may vary between different CPUs.

---

**NOTE:** The following item appears only when **Optimized Performance Setting** is set to **[Default]** or **[By Benchmark]**.

---

### Engine Boost [Disabled]

Enable this item to boost the CPU's frequency. Recommended operation at an ambient temperature of 25°C or below for optimized performance.

Configuration options: [Disabled] [Normal] [Aggressive]

---

**NOTE:** Operate with an ambient temperature of 25°C or lower for optimized performance.

---

## Overclocking [Disabled]

Enable this item to increase the CPU's clock. Please use an external PCIe storage controller for your hard drives when enabling this feature.

Configuration options: [Disabled] [Enabled]

---

**CAUTION:** Please note that overclocking might cause component damage or system crashes, which may reduce the lifespan of the system and the CPU. Use this tool at your own risk.

---

**NOTE:** The following item appears only when **Core Optimizer** is set to [Disabled], or if **Optimized Performance Setting** is set to [Default] or [By Benchmark].

---

## Power Balancer [Disabled]

Allows you to dynamically adjust the frequency of all CPU cores based on their current utilization, delivering better performance per watt for improved system energy efficiency.

Configuration options: [Disabled] [Enabled by ACC]

---

**CAUTION:** When setting **Power Balancer** to [Enabled by ACC], make sure that you have the latest ASUS Control Center software installed to support Power Balancer. Please see below for recommended software versions:

- **ACC:** 1.4.3.5 version or above.

---

**NOTE:** The following item appears only when **Power Balancer** is set to [Enabled by ACC].

---

## Policy [Auto]

Configuration options: [Auto] [Manual]

---

**NOTE:** The following item appears only when set **Policy** is set to [Manual].

---

## CPU Max frequency [XXXX]

The default value for this option will be the maximum supported frequency of the CPU installed and may vary between different CPUs.

## 4.5 Advanced menu

The Advanced menu items allow you to change the settings for the CPU and other system devices.

**CAUTION:** Take caution when changing the settings of the Advanced menu items. Incorrect field values can cause the system to malfunction.

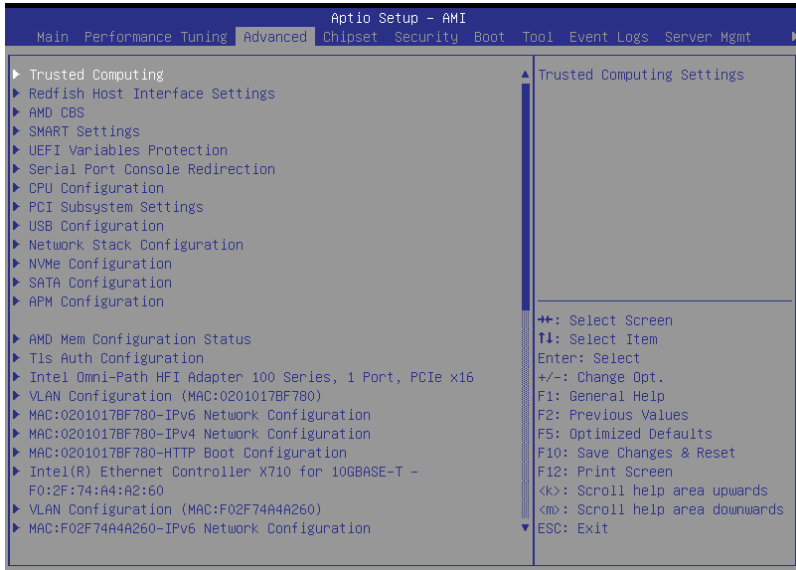

### 4.5.1 Trusted Computing

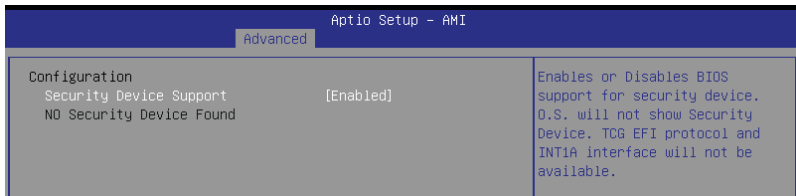

#### Security Device Support [Enabled]

Allows you to enable or disable the BIOS support for security device.

Configuration options: [Disabled] [Enabled]

## 4.5.2 Redfish Host Interface Settings

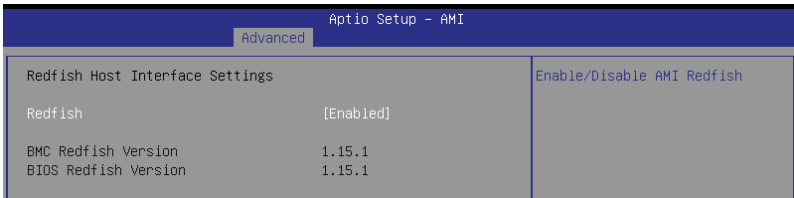

### Redfish [Enabled]

Allows you to enable or disable AMI Redfish.

Configuration options: [Disabled] [Enabled]

---

**NOTE:** The following item appears only when **Redfish** is set to **[Enabled]**.

---

### Authentication Mode [Basic Authentication]

Configuration options: [Basic Authentication] [Session Authentication] [Authentication None]

### IP Address

Allows you to set the IP address

### IP Mask Address

Allows you to set the IP mask address

### IP Port

Allows you to set the IP port

## 4.5.3 AMD CBS

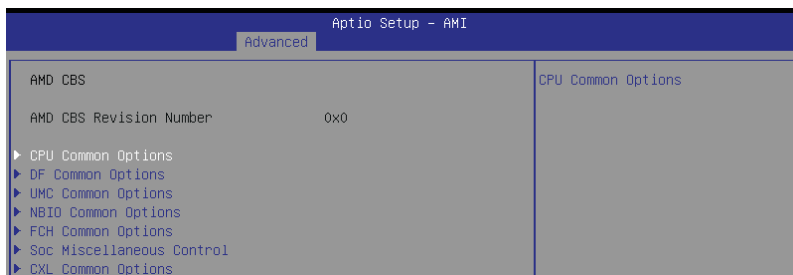

### CPU Common Options

#### Performance

Allows you to configure performance options.

#### REP-MOV/STOS Streaming [Enabled]

Allows you to enable or disable the use of non-caching streaming stores for large sizes.

Configuration options: [Disabled] [Enabled]

#### Prefetcher Settings

Allows you to configure prefetcher options.

#### Core Watchdog

Allows you to configure core watchdog options.

#### RedirectForReturnDis [Auto]

Allows you to set RedirectForReturnDis to 0, 1, or Auto as a workaround for GCC/C000005 issue for XV Core on CZ A0.

Configuration options: [Auto] [1] [0]

#### Platform First Error Handling [Auto]

Allows you to enable or disable PFEH, cloak individual banks, and mask deferred error interrupts from each bank.

Configuration options: [Disabled] [Enabled] [Auto]

#### Core Performance Boost [Auto]

Configuration options: [Disabled] [Auto]



**Global C-State Control [Auto]**

Configuration options: [Disabled] [Enabled] [Auto]

**Power Supply Idle Control [Auto]**

Configuration options: [Low Current Idle] [Typical Current Idle] [Auto]

**Streaming Stores Control [Auto]**

Configuration options: [Disabled] [Enabled] [Auto]

**Local APIC Mode [Auto]**

Configuration options: [Compatibility] [xAPIC] [x2APIC] [Auto]

**ACPI\_CST C1 Declaration [Auto]**

Configuration options: [Disabled] [Enabled] [Auto]

**ACPI CST C2 Latency [100]**

Allows you to set the C2 latency value in microseconds.

**MCA Error Threshold Enable [Auto]**

Configuration options: [False] [True] [Auto]

---

**NOTE:** The following item appears only when **MCA Error Threshold Enable** is set to **[True]**.

---

***MCA Error Threshold Count [FF5]***

Allows you to set the MCA error threshold count.

**MCA FruText [True]**

Configuration options: [False] [True]

**SMU and PSP Debug Mode [Auto]**

If this option is enabled, uncorrected errors detected by the PSP FW or SMU FW will hang and not reset the system instead of causing a cold reset.

Configuration options: [Disabled] [Enabled] [Auto]

**PPIN Opt-in [Auto]**

Configuration options: [Disabled] [Enabled] [Auto]

## **SMEE [Auto]**

Configuration options: [Disabled] [Enabled] [Auto]

---

**NOTE:** The following item appears only when **SMEE** is set to **[Enabled]**.

---

### ***SEV Control [Enabled]***

Configuration options: [Disabled] [Enabled]

### ***SEV-ES ASID Space Limit [1]***

Allows you to set the SEV-ES ASID Space Limit.

### ***SNP Memory (RMP Table) Coverage [Auto]***

Configuration options: [Disabled] [Enabled] [Custom] [Auto]

---

**NOTE:** The following items appear only when **SNP Memory (RMP Table) Coverage** is set to **[Enabled]** or **[Custom]**.

---

### ***Split RMP Table [Auto]***

Configuration options: [Disabled] [Enabled] [Auto]

### ***Segmented RMP Table [Auto]***

Configuration options: [Disabled] [Enabled] [Auto]

### ***RMP Segment Size [Auto]***

Configuration options: [Disabled] [Enabled] [Auto]

---

**NOTE:** The following item appears only when **SNP Memory (RMP Table) Coverage** is set to **[Enabled]**.

---

### ***RMP Coverage for 64Bit MMIO Ranges [Auto]***

Configuration options: [Disabled] [Enabled] [Auto]

---

**NOTE:** The following item appears only when **SNP Memory (RMP Table) Coverage** is set to **[Custom]**.

---

### ***Amount of Memory to Cover [0]***

Allows you to set the amount of system memory (MB) to be covered in hex.

**Action on BIST Failure [Auto]**

Allows you to configure what action is taken when a CCD BIST failure is detected.

Configuration options: [Do nothing] [Down-CCD] [Auto]

**Enhanced Short REP MOVSB/STOSB (ESRM) [Auto]**

Configuration options: [Disabled] [Enabled] [Auto]

**Log Transparent Errors [Auto]**

Configuration options: [Disabled] [Enabled] [Auto]

**AVX512 [Auto]**

Configuration options: [Disabled] [Enabled] [Auto]

**Enhanced REP MOVSB STOS B [Auto]**

Configuration options: [Disabled] [Enabled] [Auto]

**MONITOR and MWAIT Disable [Auto]**

When this option is enabled, MONITOR, MWAIT, MONITORX, and MWAITX opcodes become invalid.

Configuration options: [Disabled] [Enabled] [Auto]

**CPU Speculative Store Modes [Auto]**

Configuration options: [Balanced] [More Speculative] [Auto]

**Fast Short REP MOVSB (FSRM) [Auto]**

Configuration options: [Disabled] [Enabled] [Auto]

**PauseCntSel\_1\_0 [Auto]**

Configuration options: [Auto] [16 cycles] [32 cycles] [64 cycles] [128 cycles]

**Prefetch/Request Throttle [Auto]**

Configuration options: [Disabled] [Enabled] [Auto]

**Scan Dump Debug Enable [Disabled]**

Configuration options: [Disabled] [Enabled]

**MCAX 64 Bank Support [Auto]**

Configuration options: [Disabled] [Enabled] [Auto]

**Adaptive Allocation (AA) [Auto]**

Configuration options: [Disabled] [Enabled] [Auto]

**Latency Under Load (LUL) [Auto]**

Configuration options: [Disabled] [Enabled] [Auto]

**Core Trace Dump Enable [Disabled]**

Configuration options: [Disabled] [Enabled]

**FP512 [Auto]**

Configuration options: [Disabled] [Enabled] [Auto]

## DF Common Options

### Memory Addressing

Allows you to configure memory addressing options.

### ACPI

Allows you to configure ACPI options.

### Link

Allows you to configure Link options.

### SDCI

Allows you to configure SDCI options.

### Probe Filter

Allows you to configure Probe Filter options.

### DF Watchdog Timer Interval [Auto]

Configuration options: [Auto] [41ms] [166ms] [334ms] [669ms] [1.34 seconds] [2.68 seconds] [5.36 seconds]

### Disable DF to external IP Sync Flood Propagation [Auto]

Configuration options: [Sync flood disabled] [Sync flood enabled] [Auto]

### Sync Flood Propagation to DF Components [Auto]

Configuration options: [Sync flood disabled] [Sync flood enabled] [Auto]

### Freeze DF Module Queues on Error [Auto]

Configuration options: [Disabled] [Enabled] [Auto]

### CC6 Memory Region Encryption [Auto]

Configuration options: [Disabled] [Enabled] [Auto]

### CC6 B/W Balance Throttle Level [Auto]

Configuration options: [Auto] [Level 0] [Level 1] [Level 2] [Level 3] [Level 4]

### Number of PCI Segments [Auto]

Configuration options: [Auto] [1 Segment] [2 Segments] [4 Segments]

### **CCM Throttler [Auto]**

Configuration options: [Disabled] [Enabled] [Auto]

---

**NOTE:** The following item appears only when **CCM Throttler** is set to **[Enabled]**.

---

#### ***MemReqBandwidthControl [FineThrotHeavy] [0]***

Allows you to set the CCM throttle limit.

#### ***MemReqBandwidthControl [FineThrotLight] [0]***

Allows you to set the CCM throttle limit.

### **Clean Victim FTI Cmd Balancing [Auto]**

Configuration options: [Disabled] [Enabled] [Auto]

---

**NOTE:** The following item appears only when **Clean Victim FTI Cmd Balancing** is set to **[Enabled]**.

---

#### ***CCMConfig5 [ReqvReqNDImbThr] [Auto]***

Configuration options: [Auto] [1h] [2h] [3h] [4h] [5h] [6h] [7h]

### **CXL Strongly Ordered Writes [Disabled]**

Configuration options: [Disabled] [One at a time]

## **UMC Common Options**

#### **DDR Addressing Options**

Allows you to configure DDR addressing options.

#### **DDR Controller Configuration**

Allows you to configure DDR controller options.

#### **DDR MBIST Options**

Allows you to configure DDR MBIST options.

#### **DDR RAS**

Allows you to configure DDR RAS options.

#### **DDR Bus Configuration**

Allows you to configure DDR Bus options.

#### **DDR Timing Configuration**

Allows you to configure DDR Timing options.

**DDR Training Options**

Allows you to configure DDR Training options.

**DDR Security**

Allows you to configure DDR Security options.

**DDR PMIC Configuration**

Allows you to configure DDR PMIC options.

**DDR Thermal Throttling**

Allows you to configure DDR Thermal Throttling options.

**DDR Miscellaneous**

Allows you to configure DDR Miscellaneous options.

**NBIO Common Options****SMU Common Options**

Allows you to configure SMU Common options.

**NBIO RAS Common Options**

Allows you to configure NBIO RAS Common options.

**PCIE**

Allows you to configure PCIE options.

**nBif Common Options**

Allows you to configure nBif Common options.

**IOMMU/Security**

Allows you to configure IOMMU/Security options.

**Enable Port Bifurcation**

Allows you to configure Port Bifurcation options.

**Link EQ Preset Options**

Allows you to configure Link EQ Preset options.

**PCIe Loopback Mode [Auto]**

Configuration options: [Disabled] [Enabled] [Auto]

**Enable 2SPC (Gen 4) [Auto]**

Configuration options: [Disabled] [Enabled] [Auto]

**Enable 2SPC (Gen 5) [Auto]**

Configuration options: [Disabled] [Enabled] [Auto]

**Safe recovery upon a BERExceeded Error [Auto]**

Configuration options: [Disabled] [Enabled] [Auto]

**Periodic Calibration [Auto]**

Configuration options: [Disabled] [Enabled] [Auto]

## FCH Common Options

### **I3C/I2C Configuration Options**

Allows you to configure I3C/I2C options.

### **SATA Configuration Options**

Allows you to configure SATA options.

### **USB Configuration Options**

Allows you to configure USB options.

### **AC Power Loss Options**

Allows you to configure AC power loss options.

### **UART Configuration Options**

Allows you to configure UART options.

### **FCH RAS Options**

Allows you to configure FCH RAS options.

### **Miscellaneous Options**

Allows you to configure miscellaneous FCH options.

## SOC Miscellaneous Control

### **ABL Console Out Control [Auto]**

Configuration options: [Disabled] [Enabled] [Auto]

---

**NOTE:** The following items appear only when **ABL Console Out Control** is set to **[Enabled]**.

---

#### ***ABL Console Out Serial Port [Auto]***

Configuration options: [eSPI UART] [SOC UART0] [SOC UART1] [Auto]

#### ***ABL Console Out Serial Port IO [Auto]***

Configuration options: [0x3F8] [0x2F8] [0x3E8] [0x2E8] [Auto]

#### ***ABL Serial Port IO Customized Enabled [Disabled]***

Configuration options: [Disabled] [Enabled]

#### ***ABL Basic Console Out Control [Auto]***

Configuration options: [Disabled] [Enabled] [Auto]

#### ***ABL PMU Message Control [Auto]***

Allows you to control the number of PMU debug messages.

Configuration options: [Detailed debug messages] [Coarse debug messages] [Stage completion] [Auto]

**ABL Memory Population Message Control [Warning Message]**

Configuration options: [Warning Message] [Fatal Error]

**PSP Error Injection Support [False]**

Configuration options: [False] [True]

**Firmware Anti-rollback (FAR)**

Allows you to configure Firmware Anti-Rollback (FAR) options.

**SEC\_I2C Voltage Mode [Auto]**

Configuration options: [Auto] [1.8V] [1.1V]

**CXL Common Options**

**CXL Control [Auto]**

Configuration options: [Disabled] [Enabled] [Auto]

**CXL Physical Addressing [Auto]**

Configuration options: [Normalized address] [System address] [Auto]

**CXL Memory Attribute [Auto]**

Configuration options: [Disabled] [Enabled] [Auto]

**CXL Encryption [Disabled]**

Configuration options: [Disabled] [Enabled]

**CXL DVSEC Lock [Auto]**

Configuration options: [Disabled] [Enabled] [Auto]

**CXL HDM Decoder Lock On Commit [Auto]**

Configuration options: [Disabled] [Enabled] [Auto]

**Temp Gen5 Advertisement [Auto]**

Configuration options: [Disabled] [Enabled] [Auto]

**Sync Header Bypass [Auto]**

Configuration options: [Disabled] [Enabled] [Auto]

**Sync Header Bypass Compatibility Mode [Auto]**

Configuration options: [Disabled] [Enabled] [Auto]

**CXL RAS**

Allows you to configure CXL RAS options.

**CXL Memory Online/Offline [Disabled]**

Configuration options: [Disabled] [Enabled]

**Override CXL Memory Size [Auto]**

Configuration options: [32GB] [64GB] [128GB] [Auto]



## 4.5.4 SMART Settings

Advanced		Aptio Setup - AMI
SMART Settings		
SMART Self Test	[Enabled]	The S.M.A.R.T.(self-monitoring, analysis and reporting technology) is a monitor system. Enable this item to show a warning message during the POST(power-on self-test) when any error occurs in hard disks.

### SMART Self Test [Enabled]

Configuration options: [Disabled] [Enabled]

## 4.5.5 UEFI Variables Protection

Advanced		Aptio Setup - AMI
Password protection of Runtime Variables	[Disabled]	Control the NVRAM Runtime Variable protection through System Admin Password

### Password Protection of Runtime Variables [Disabled]

Configuration options: [Disabled] [Enabled]

## 4.5.6 Serial Port Console Redirection

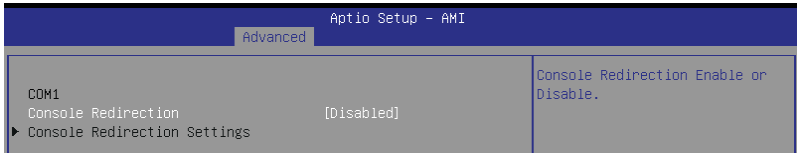

### COM1/COM2(SOL)

#### Console Redirection [Disabled]

Allows you to enable or disable the console redirection feature.

Configuration options: [Disabled] [Enabled]

---

**NOTE:** The following items appear only when **Console Redirection** is set to **[Enabled]**.

---

#### Terminal Type [VT100Plus]

Allows you to set the terminal type.

[VT100] ASCII char set.

[VT100Plus] Extends VT100 to support color, function keys, etc.

[VT-UTF8] Uses UTF8 encoding to map Unicode chars onto 1 or more bytes.

[ANSI] Extended ASCII char set.

#### Bits per second [115200]

Selects serial port transmission speed. The speed must be matched on the other side. Long or noisy lines may require lower speeds.

Configuration options: [9600] [19200] [38400] [57600] [115200]

#### Data Bits [8]

Configuration options: [7] [8]

#### Parity [None]

A parity bit can be sent with the data bits to detect some transmission errors. [Mark] and [Space] parity do not allow for error detection.

[None] None

[Even] parity bit is 0 if the num of 1's in the data bits is even

[Odd] parity bit is 0 if num of 1's in the data bits is odd

[Mark] parity bit is always 1

[Space] parity bit is always 0

#### Stop Bits [1]

Stop bits indicate the end of a serial data packet. (A start bit indicates the beginning.)

The standard setting is 1 stop bit. Communication with slow devices may require more than 1 stop bit.

Configuration options: [1] [2]

**Flow Control [Hardware RTS/CTS]**

Flow control can prevent data loss from buffer overflow. When sending data, if the receiving buffers are full, a “stop” signal can be sent to stop the data flow. Once the buffers are empty, a “start” signal can be sent to re-start the flow. Hardware flow control uses two wires to send start/stop signals.

Configuration options: [None] [Hardware RTS/CTS]

**VT-UTF8 Combo Key Support [Enabled]**

This allows you to enable the VT-UTF8 Combination Key Support for ANSI/VT100 terminals.

Configuration options: [Disabled] [Enabled]

**Recorder Mode [Disabled]**

With this mode enabled only text will be sent. This is to capture Terminal data.

Configuration options: [Disabled] [Enabled]

**Resolution 100x31 [Enabled]**

This allows you to set the number of rows and columns supported on the Legacy OS.

Configuration options: [Disabled] [Enabled]

**Putty Keypad [VT100]**

This allows you to select the FunctionKey and Keypad on Putty.

Configuration options: [VT100] [LINUX] [XTERMR6] [SCO] [ESCN] [VT400]

## Serial Port for Out-of-Band Management/ Windows Emergency Management Service (EMS)

### Console Redirection EMS [Disabled]

Allows you to enable or disable the console redirection feature.  
Configuration options: [Disabled] [Enabled]

---

**NOTE:** The following items appear only when **Console Redirection EMS** is set to **[Enabled]**.

---

#### Console Redirection Settings

##### Out-of-Band Mgmt Port [COM1]

Microsoft Windows Emergency Management Services (EMS) allow for remote management of a Windows Server OS through a serial port.  
Configuration options: [COM1] [COM2]

##### Terminal Type EMS [VT-UTF8]

Microsoft Windows Emergency Management Services (EMS) allow for remote management of a Windows Server OS through a serial port.  
Configuration options: [VT100] [VT100Plus] [VT-UTF8] [ANSI]

##### Bits per second EMS [115200]

Microsoft Windows Emergency Management Services (EMS) allow for remote management of a Windows Server OS through a serial port.  
Configuration options: [9600] [19200] [57600] [115200]

##### Flow Control EMS [None]

Microsoft Windows Emergency Management Services (EMS) allow for remote management of a Windows Server OS through a serial port.  
Configuration options: [None] [Hardware RTS/CTS] [Software Xon/Xoff]

## 4.5.7 CPU Configuration

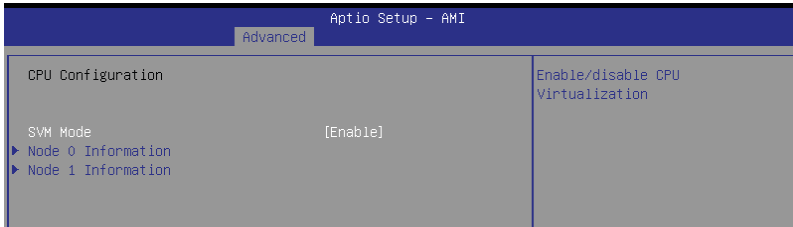

### SVM Mode [Enabled]

This item allows you to enable or disable CPU Virtualization.  
Configuration options: [Disabled] [Enable]

### Node Information

This item allows you to view memory information related to the selected node.

## 4.5.8 PCI Subsystem Settings

Advanced		Aptio Setup - AMI
PCI Devices Common Settings:		Value to be programmed into PCI Latency Timer Register.
PCI Latency Timer	[32 PCI Bus Clocks]	
PCI-X Latency Timer	[64 PCI Bus Clocks]	
VGA Palette Snoop	[Disabled]	
PERR# Generation	[Disabled]	
SERR# Generation	[Disabled]	
Resize BAR Support	[Disabled]	
SR-IOV Support	[Enabled]	
▶ PCI Express Settings		

### PCI Latency Timer [32 PCI Bus Clocks]

Configuration options: [32 PCI Bus Clocks] [64 PCI Bus Clocks] [96 PCI Bus Clocks] [128 PCI Bus Clocks] [160 PCI Bus Clocks] [192 PCI Bus Clocks] [224 PCI Bus Clocks] [248 PCI Bus Clocks]

### PCI-X Latency Timer [64 PCI Bus Clocks]

Configuration options: [32 PCI Bus Clocks] [64 PCI Bus Clocks] [96 PCI Bus Clocks] [128 PCI Bus Clocks] [160 PCI Bus Clocks] [192 PCI Bus Clocks] [224 PCI Bus Clocks] [248 PCI Bus Clocks]

### VGA Palette Snoop [Disabled]

Configuration options: [Disabled] [Enabled]

### PERR# Generation [Disabled]

Configuration options: [Disabled] [Enabled]

### SERR# Generation [Disabled]

Configuration options: [Disabled] [Enabled]

### Re-Size BAR Support [Disabled]

Configuration options: [Disabled] [Auto]

### SR-IOV Support [Enabled]

Configuration options: [Disabled] [Enabled]

### PCI Express Settings

Allows you to configure PCI Express options.

### PCI Express GEN 2 Settings

Allows you to configure PCI Express GEN 2 options.

### PCI Hot-Plug Settings

Allows you to configure PCI Hot-Plug options.

## 4.5.9 USB Configuration

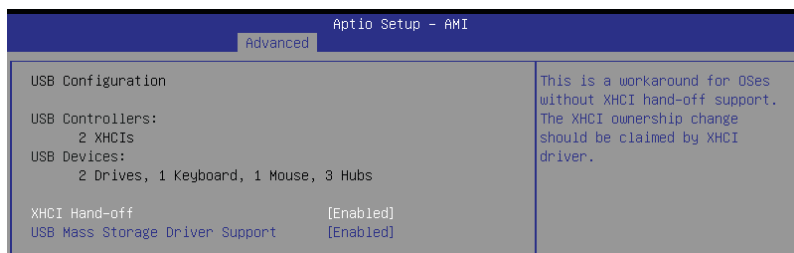

### **XHCI Hand-off [Enabled]**

Configuration options: [Enabled] [Disabled]

### **USB Mass Storage Driver Support [Enabled]**

Configuration options: [Disabled] [Enabled]

### **Mass Storage Devices**

Allows you to select the mass storage device emulation type for devices connected.

Configuration options: [Auto] [Floppy] [Forced FDD] [Hard Disk] [CD-ROM]

## 4.5.10 Network Stack Configuration

Aptio Setup - AMI		
Advanced		
Network Stack	[Enabled]	Enable/Disable UEFI Network Stack
IPv4 PXE Support	[Enabled]	
IPv4 HTTP Support	[Enabled]	
IPv6 PXE Support	[Disabled]	
IPv6 HTTP Support	[Disabled]	
PXE boot wait time	0	
Media detect count	1	

### Network Stack [Enabled]

Configuration options: [Disabled] [Enabled]

---

**NOTE:** The following items appear only when **Network Stack** is set to **[Enabled]**.

---

#### IPv4 PXE Support [Enabled]

Configuration options: [Disabled] [Enabled]

#### IPv4 HTTP Support [Enabled]

Configuration options: [Disabled] [Enabled]

#### IPv6 PXE Support [Disabled]

Configuration options: [Disabled] [Enabled]

#### IPv6 HTTP Support [Disabled]

Configuration options: [Disabled] [Enabled]

#### PXE boot wait time [0]

Wait time to press ESC key to abort the PXE boot.

#### Media detect count [1]

Wait time (in seconds) to detect media.

### 4.5.11 NVMe Configuration

This page will display the NVMe controller and drive information.



### 4.5.12 SATA Configuration

This page will display the SATA controller and drive information.

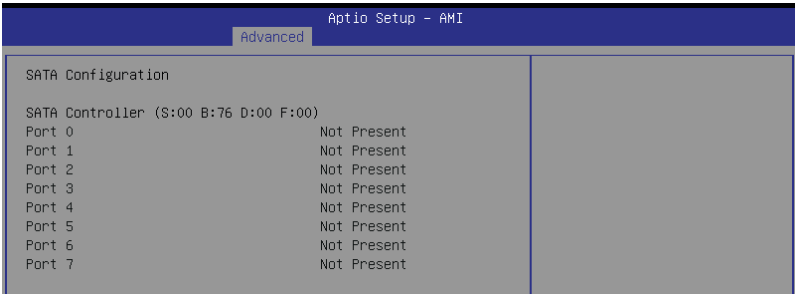



## 4.5.13 APM Configuration

Allows you to configure the Advance Power Management (APM) settings.

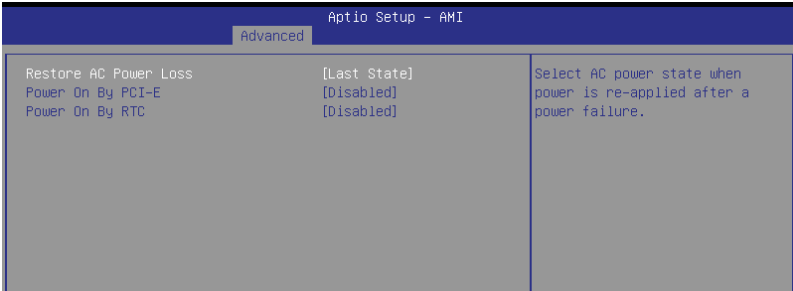

### Restore AC Power Loss [Last State]

When set to [Power Off], the system goes into off state after an AC power loss. When set to [Power On], the system will reboot after an AC power loss. When set to [Last State], the system goes into either off or on state, whatever the system state was before the AC power loss.

Configuration options: [Power On] [Power Off] [Last State]

### Power On By PCI-E [Disabled]

[Disabled] Disables the PCIE devices to generate a wake event.

[Enabled] Enables the PCIE devices to generate a wake event.

### Power On By RTC [Disabled]

[Disabled] Disables RTC to generate a wake event.

[Enabled] When set to [Enabled], the items **RTC Alarm Date (Days)** and **Hour/Minute/Second** will become user-configurable with set values.

## 4.5.14 AMD Mem Configuration Status

The items in this menu display the memory configuration (initialized by ABL) status.

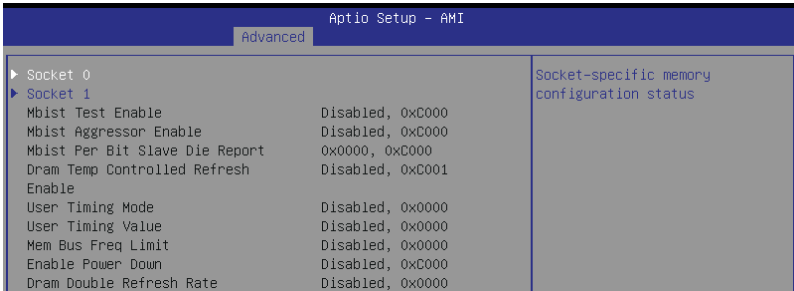

## 4.5.15 T1s Auth

Allows you to configure the Server Certificate Authority (CA).

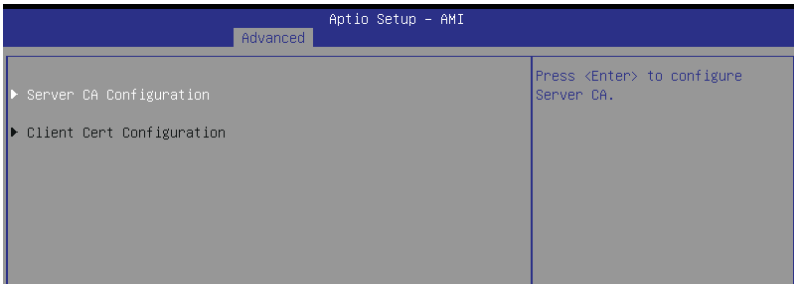

### Server / Client CA Configuration

#### Enroll Cert

Allows you to enroll a certificate using a certificate file or manually input a certificate GUID.

##### **Enroll Cert Using File**

Allows you to enroll a certificate using a certificate file. You will be prompted to select a storage device and navigate to the location of the certificate file.

##### **Cert GUID**

Allows you to enroll a certificate by manually inputting the certificate GUID.

##### **Commit Changes and Exit**

Exit Server CA configuration after saving the changes.

##### **Discard Changes and Exit**

Exit Server CA configuration without saving any changes.

#### Delete Cert

Allows you to delete the certificate.

## 4.5.16 Driver Health

This page will display the driver and controller health status.

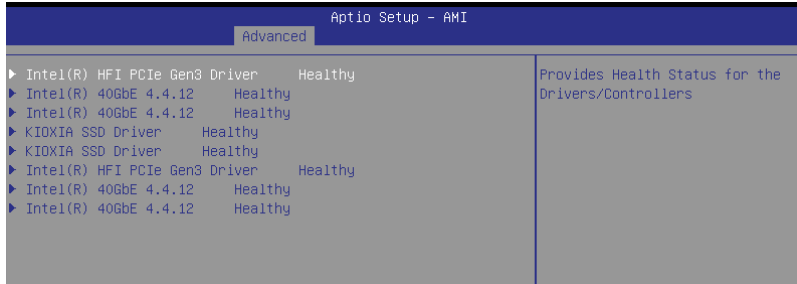

## 4.5.17 Third-party UEFI driver configurations

Additional configuration options for third-party UEFI drivers installed to the system will appear in the section marked in red in the screenshot below.

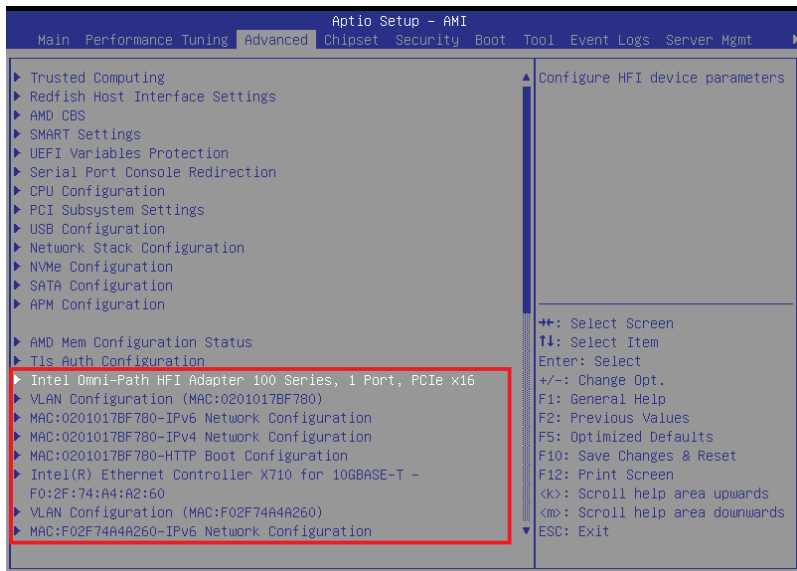

## 4.6 Chipset menu



### PCIe Compliance Mode [Off]

This item allows you to turn the PCIe Compliance Mode on or off.

Configuration options: [Off] [On]

### PCH Configuration

#### SB Debug Configuration

Allows you to configure SB Debug options.

### System Agent (SA) Configuration

#### Socket Information

This item displays the memory information for the selected socket.

## 4.7 Security menu

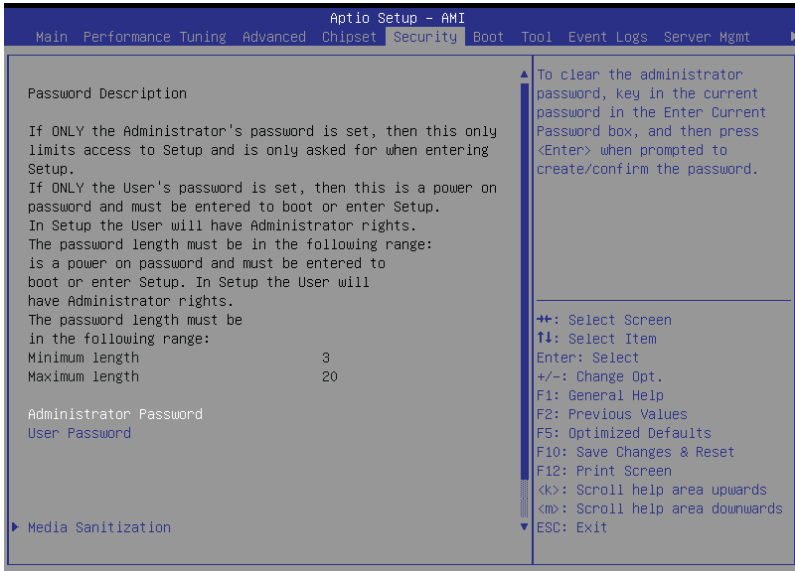

### Administrator Password

To set an administrator password:

1. Select the Administrator Password item and press <Enter>.
2. From the Create New Password box, key in a password, then press <Enter>.
3. Confirm the password when prompted.

To change an administrator password:

1. Select the Administrator Password item and press <Enter>.
2. From the Enter Current Password box, key in the current password, then press <Enter>.
3. From the Create New Password box, key in a new password, then press <Enter>.
4. Confirm the password when prompted.

---

**NOTE:** To clear the administrator password, follow the same steps as in changing an administrator password, but press <Enter> when prompted to create/confirm the password.

---

## User Password

To set a user password:

1. Select the User Password item and press <Enter>.
2. From the Create New Password box, key in a password, then press <Enter>.
3. Confirm the password when prompted.

To change a user password:

1. Select the User Password item and press <Enter>.
2. From the Enter Current Password box, key in the current password, then press <Enter>.
3. From the Create New Password box, key in a new password, then press <Enter>.
4. Confirm the password when prompted.

---

**NOTE:** To clear the user password, follow the same steps as in changing a user password, but press <Enter> when prompted to create/confirm the password.

---

## Media Sanitization

This item allows you to sanitize selected drives. After selecting the drive you wish to sanitize, select the Method Type from between [Clear] or [Purge]. The default method is set to [Clear], and will apply logical techniques to sanitize data in all user-addressable storage locations through standard Read and Write commands to the storage device.

When [Purge] is selected, it will apply physical or logical techniques that render Target Data recovery infeasible using state-of-the-art laboratory techniques.

## Secure Boot

### Secure Boot [Disabled]

Secure Boot can be enabled if the system is running in User mode with enrolled platform Key (EPK) or if the CSM function is disabled.

Configuration options: [Disabled] [Enabled]

### Secure Boot Mode [Custom]

Allows you to set the Secure Boot selector.

Configuration options: [Standard] [Custom]

### Restore Factory Keys

Allows you to restore the factory keys.

### Reset To Setup Mode

Allows you to reset to setup mode.

### Expert Key Management

Allows you to configure Expert Key Management options.

## 4.8 Boot menu

The Boot menu items allow you to change the system boot options.

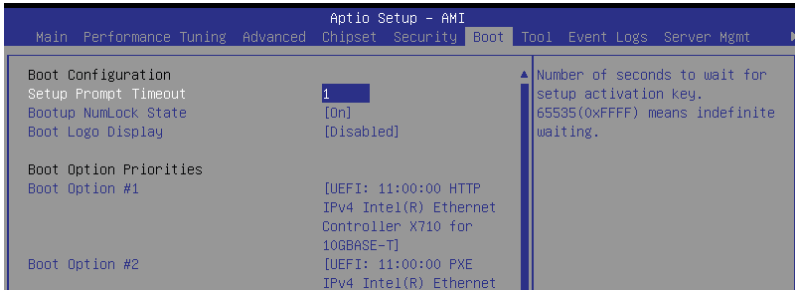

### Setup Prompt Timeout [1]

Allows you to set the number of seconds that the firmware waits before initiating the original default boot selection. 65535 (0xFFFF) means indefinite waiting. Use the <+> or <-> to adjust the value.

### Bootup NumLock State [On]

Allows you to select the power-on state for the NumLock.  
Configuration options: [On] [Off]

### Boot Logo Display [Disabled]

Allows you to enable or disable Quiet Boot option.  
Configuration options: [Disabled] [Enabled]

### Boot Option Priorities

These items specify the boot device priority sequence from the available devices. The number of device items that appears on the screen depends on the number of devices installed in the system.

---

**NOTE:** To select the boot device during system startup, press <F8> when ASUS Logo appears.

---

### POST Report [5 sec]

Allows you to set the desired POST Report waiting time from 1 to 10 seconds.  
Configuration options: [1 sec] - [10 sec] [Until Press ESC]

### Hard Drive BBS Priorities

These items appear only when you connect a network cable or SATA ODD to the SATA port, and allows you to set the booting order of the Network / SATA devices.

## 4.9 Tool menu

The Tool menu items allow you to configure options for special functions. Select an item and press <Enter> to display the submenu.

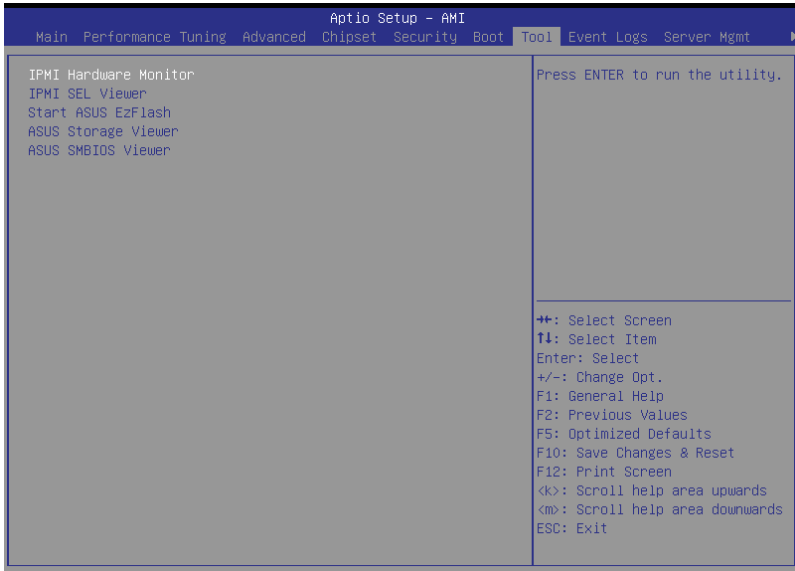

### IPMI Hardware Monitor

Allows you to run the IPMI hardware monitor.

### IPMI SEL Viewer

Allows you to run the IPMI SEL viewer.

### Start ASUS EzFlash

Allows you to run ASUS EZ Flash BIOS ROM Utility. Refer to the ASUS EZ Flash Utility section for details.

### ASUS Storage Viewer

Allows you to run ASUS Storage Viewer.

### ASUS SMBIOS Viewer

Allows you to run ASUS SMBIOS Viewer.



## 4.10 Event Logs menu

The Event Logs menu items allow you to change the event log settings and view the system event logs.

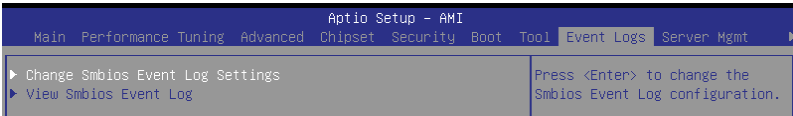

### 4.10.1 Change Smbios Event Log Settings

Press <Enter> to change the Smbios Event Log configuration.

---

**NOTE:** All values changed here do not take effect until computer is restarted.

---

#### **Smbios Event Log [Enabled]**

Change this to enable or disable all features of Smbios Event Logging during boot.  
Configuration options: [Disabled] [Enabled]

---

**NOTE:** The following item appears only when **Smbios Event Log** is set to **[Enabled]**.

---

#### **Erase Event Log [No]**

Choose options for erasing Smbios Event Log. Erasing is done prior to any logging activation during reset.

Configuration options: [No] [Yes, Next reset] [Yes, Every reset]

#### **When Log is Full [Do Nothing]**

Choose options for reactions to a full Smbios Event Log.

Configuration options: [Do Nothing] [Erase Immediately]

#### **Log EFI Status Code [Enabled]**

This option allows you to enable or disable logging of the EFI Status Codes.

Configuration options: [Disabled] [Enabled]

---

**NOTE:** The following item appears only when **Log EFI Status Code** is set to **[Enabled]**.

---

#### ***Convert EFI Status Codes to Standard Smbios Type [Disabled]***

This option allows you to enable or disable converting of EFI Status Codes to Standard Smbios Type (Not all may be translated).

Configuration options: [Disabled] [Enabled]

### 4.10.2 View Smbios Event Log

Press <Enter> to view all smbios event logs.

## 4.11 Server Mgmt menu

The Server Management menu displays the server management status and allows you to change the settings.



Aptio Setup - AMI		
Main Performance Tuning Advanced Chipset Security Boot Tool Event Logs Server Mgmt		
BMC Self Test Status	PASSED	If enabled, starts a BIOS timer which can only be shut off by Management Software after the OS loads. Helps determine that the OS successfully loaded or follows the OS Boot Watchdog Timer policy.
BMC Device ID	32	
BMC Device Revision	81	
BMC Firmware Revision	1.01.13	
IPMI Version	2.0	
OS Watchdog Timer	[Disabled]	
OS Wtd Timer Timeout	10	
OS Wtd Timer Policy	[Reset]	
ASUS PLDM version	5.0	

### OS Watchdog Timer [Disabled]

This item allows you to start a BIOS timer which can only be shut off by management software after the OS loads.

Configuration options: [Enabled] [Disabled]

---

**NOTE:** The following items appear only when **OS Watchdog Timer** is set to **[Enabled]**.

---

#### OS Wtd Timer Timeout [10]

Enter the value between 1 to 30 minutes to configure the length for the OS Boot Watchdog Timer.

#### OS Wtd Timer Policy [Reset]

This item allows you to configure how the system should respond if the OS Boot Watchdog Timer expires.

Configuration options: [Do Nothing] [Reset] [Power Down] [Power Cycle]

### 4.11.1 System Event Log

Allows you to change the SEL event log configuration.

#### Erase SEL [No]

Allows you to choose options for erasing SEL.

Configuration options: [No] [Yes, On next reset] [Yes, On every reset]

### 4.11.2 BMC network configuration

The sub-items in this configuration allow you to configure the BMC network parameters.

### 4.11.3 View System Event Log

This item allows you to view the system event log records.

## 4.12 Exit menu

The Exit menu items allow you to save or discard your changes to the BIOS items.

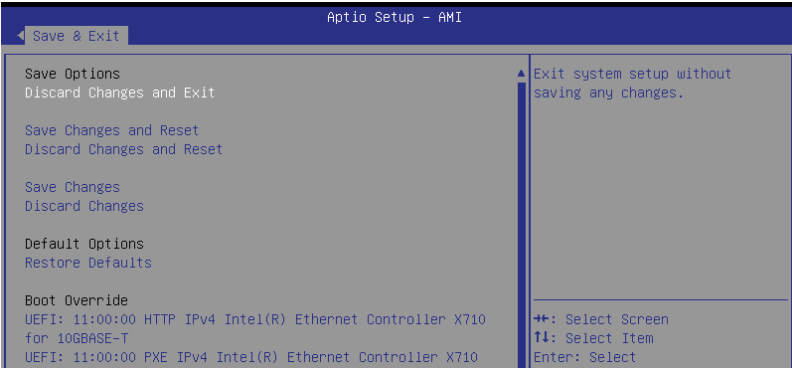

### Discard Changes and Exit

Exit system setup without saving any changes.

### Save Changes and Reset

Reset the system after saving the changes.

### Discard Changes and Reset

Reset system setup without saving any changes.

### Save Changes

Save changes done so far to any of the setup options.

### Discard Changes

Discard changes done so far to any of the setup options.

### Boot Override

These items displays the available devices. The device items that appears on the screen depends on the number of devices installed in the system. Click an item to start booting from the selected device.

### Launch EFI Shell from filesystem device

This item allows you to attempt to launch the EFI Shell application (shellx64.efi) from one of the available filesystem devices.



# Appendix

This appendix includes additional information that you may refer to when configuring the motherboard.

# Block diagram

## RS700A-E13-RS4U

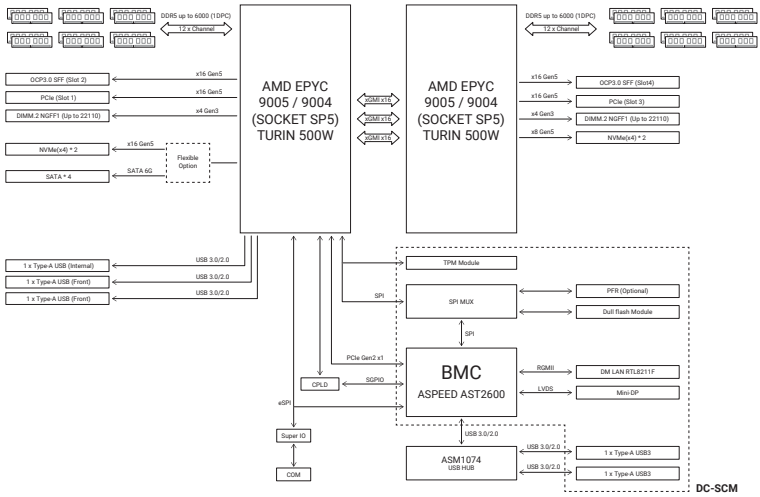

## RS700A-E13-RS12U

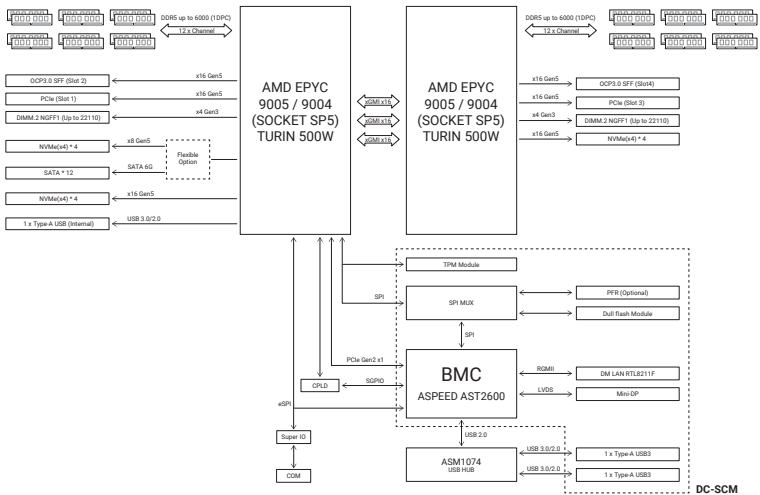

## Q-Code table

ACTION	PHASE	POST CODE	TYPE	DESCRIPTION
SEC Start up	Security Phase	0x01	Progress	First post code
		0x02	Progress	Load BSP microcode
		0x03	Progress	Perform early platform Initialization
		0x04	Progress	Set cache as ram for PEI phase
		0x05	Progress	Establish Stack
		0x06	Progress	CPU Early Initialization
PSP Boot	PSP Boot Loader phase (Error Post Codes)	0x00	error	General - Success
		0x01	error	Generic Error Code
		0x02	error	Generic Memory Error
		0x03	error	Buffer Overflow
		0x04	error	Invalid Parameter(s)
		0x05	error	Invalid Data Length
		0x06	error	Data Alignment Error
		0x07	error	Null Pointer Error
		0x08	error	Unsupported Function
		0x09	error	Invalid Service ID
		0x0A	error	Invalid Address
		0x0B	error	Out of Resource Error
		0x0C	error	Timeout
		0x0D	error	Data abort exception
		0x0E	error	Prefetch abort exception
		0x0F	error	Out of Boundary Condition Reached
		0x10	error	Data corruption
		0x11	error	Invalid command
		0x12	error	The package type provided by BR is incorrect
		0x13	error	Failed to retrieve FW header during FW validation
		0x14	error	Key size not supported
		0x15	error	Agesa0 verification error
		0x16	error	SMU FW verification error
		0x17	error	OEM SINGING KEY verification error
		0x18	error	Generic FW Validation error
		0x19	error	RSA operation fail - bootloader
		0x1A	error	CCP Passthrough operation failed - internal status
		0x1B	error	AES operation fail
		0x1C	error	CCP state save failed
		0x1D	error	CCP state restore failed
		0x1E	error	SHA256/384 operation fail - internal status
		0x1F	error	ZLib Decompression operation fail
		0x20	error	HMAC-SHA256/384 operation fail - internal status
		0x21	error	Booted from boot source not recognized by PSP
		0x22	error	PSP directory entry not found
		0x23	error	PSP failed to set the write enable latch
		0x24	error	PSP timed out because spirom took too long
		0x25	error	Cannot find BIOS directory
		0x26	error	SpiRom is not valid
		0x27	error	Slave die has different security state from master
		0x28	error	SMI interface init failure
		0x29	error	SMI interface generic error
		0x2A	error	Invalid die ID executes MCM related function
0x2B	error	Invalid MCM configuration table read from bootrom		
0x2C	error	Valid boot mode wasn't detected		
0x2D	error	NVStorage init failure		
0x2E	error	NVStorage generic error		
0x2F	error	MCM 'error' to indicate slave has more data to send		
0x30	error	MCM error if data size exceeds 32B		
0x31	error	Invalid client id for SVC MCM call		
0x32	error	MCM slave status register contains bad bits		
0x33	error	MCM call was made in a single die environment		
0x34	error	PSP secure mapped to invalid segment (should be 0x400_0000)		
0x35	error	No physical x86 cores were found on die		
0x36	error	Insufficient space for secure OS (range of free SRAM to SVC stack base)		
0x37	error	SYSHUB mapping memory target type is not supported		
0x38	error	Attempt to unmap permanently mapped TLB to PSP secure region		
0x39	error	Unable to map an SMN address to AXI space		
0x3A	error	Unable to map a SYSHUB address to AXI space		

(continued on the next page)

ACTION	PHASE	POST CODE	TYPE	DESCRIPTION
		0x3B	error	The count of CCXs or cores provided by bootrom is not consistent
		0x3C	error	Uncompressed image size doesn't match value in compressed header
		0x3D	error	Compressed option used in case where not supported
		0x3E	error	Fuse info on all dies don't match
		0x3F	error	PSP sent message to SMU; SMU reported an error
		0x40	error	Function RunPostX86ReleaseUnitTests failed in memcmp()
		0x41	error	Interface between PSP to SMU not available.
		0x42	error	Timer wait parameter too large
		0x43	error	Test harness module reported an error
		0x44	error	x86 wrote C2PMSG_0 interrupting PSP, but the command has an invalid format
		0x45	error	Failed to read from SPI the Bios Directory or Bios Combo Directory
		0x46	error	Failed to find FW entry in SPL Table
		0x47	error	Failed to read the combo bios header
		0x48	error	SPL version mismatch
		0x49	error	Error in Validate and Loading AGESA APOB SVC call
		0x4A	error	Correct fuse bits for DIAG_BL loading not set
		0x4B	error	The UmcProgramKeys() function was not called by AGESA
		0x4C	error	Unconditional Unlock based on serial numbers failure
		0x4D	error	Syshub register programming mismatch during readback
		0x4E	error	Family ID in MPO_SFUSE_SEC[7:3] not correct
		0x4F	error	An operation was invoked that can only be performed by the GM
		0x50	error	Failed to acquire host controller semaphore to claim ownership of SMB
		0x51	error	Timed out waiting for host to complete pending transactions
		0x52	error	Timed out waiting for slave to complete pending transactions
		0x53	error	Unable to kill current transaction on host, to force idle
		0x54	error	One of: Illegal command, Unclaimed cycle, or Host time out
		0x55	error	An smbus transaction collision detected, operation restarted
		0x56	error	Transaction failed to be started or processed by host, or not completed
		0x57	error	An unsolicited smbus interrupt was received
		0x58	error	An attempt to send an unsupported PSP-SMU message was made
		0x59	error	An error/data corruption detected on response from SMU for sent msg
		0x5A	error	MCM Steady-state unit test failed
		0x5B	error	S3 Enter failed
		0x5C	error	AGESA BL did not set PSP SMU reserved addresses via SVC call
		0x5D	error	Reserved PSP/SMU memory region is invalid
		0x5E	error	CcxSecBisiEn not set in fuse RAM
		0x5F	error	Received an unexpected result
		0x60	error	VMG Storage Init failed
		0x61	error	Failure in mbedTLS user app
		0x62	error	An error occurred whilst attempting to SMN map a fuse register
		0x63	error	Fuse burn sequence/operation failed due to internal SOC error
		0x64	error	Fuse sense operation timed out
		0x65	error	Fuse burn sequence/operation timed out waiting for burn done
		0x66	error	The PMU FW Public key certificate loading or authentication fails
		0x67	error	This PSP FW was revoked
		0x68	error	The platform model/vendor id fuse is not matching the BIOS public key token
		0x69	error	The BIOS OEM public key of the BIOS was revoked for this platform
		0x6A	error	PSP level 2 directory not match expected value.
		0x6B	error	BIOS level 2 directory not match expected value.
		0x6C	error	Reset image not found
		0x6D	error	Generic error indicating the CCP HAL initialization failed
		0x6E	error	Failure to copy NVRAM to DRAM.
		0x6F	error	Invalid key usage flag
		0x70	error	Unexpected fuse set
		0x71	error	RSMU signaled a security violation
		0x72	error	Error programming the WAFL PCS registers
		0x73	error	Error setting wait PCS threshold value
		0x74	error	Error loading OEM trustlets
		0x75	error	Recovery mode across all dies is not sync'd
		0x76	error	Uncorrectable WAFL error detected
		0x77	error	Fatal MP1 error detected
		0x78	error	Bootloader failed to find OEM signature
		0x79	error	Error copying BIOS to DRAM
		0x7A	error	Error validating BIOS image signature
		0x7B	error	OEM Key validation failed
		0x7C	error	Platform Vendor ID and/or Model ID binding violation

(continued on the next page)



ACTION	PHASE	POST CODE	TYPE	DESCRIPTION
PSP Boot	PSP Boot Loader phase (Status Post Codes)	0x7D	error	Bootloader detects BIOS request boot from SPI-ROM, which is unsupported for PSB.
		0x7E	error	Requested fuse is already blown, reblow will cause ASIC malfunction
		0x7F	error	Error with actual fusing operation
		0x80	error	(Local Master PSP on P1 socket) Error reading fuse info
		0x81	error	(Local Master PSP on P1 socket) Platform Vendor ID and/or Model ID binding violation
		0x82	error	(Local Master PSP on P1 socket) Requested fuse is already blown, reblow will cause ASIC malfunction
		0x83	error	(Local Master PSP on P1 socket) Error with actual fusing operation
		0x84	error	SEV FW Rollback attempt is detected
		0x85	error	SEV download FW command fail to broadcast and clear the IsInSRAM field on slave dies
		0x86	error	Agesa error injection failure
		0x87	error	Uncorrectable TWIX error detected
		0x88	error	Error programming the TWIX PCS registers
		0x89	error	Error setting TWIX PCS threshold value
		0x8A	error	SW CCP queue is full, cannot add more entries
		0x8B	error	CCP command description syntax error detected from input
		0x8C	error	Return value stating that the command has not yet been scheduled
		0x8D	error	The command is scheduled and being worked on
		0x8E	error	The DXIO PHY SRAM Public key certificate loading or authentication fails
		0x8F	error	FTPM binary size exceeds limit allocated in Private DRAM, need to increase the limit
		0x90	error	The TWIX link for a particular CCD is not trained Fatal error
		0x91	error	Security check failed (not all dies are in same security state)
		0x92	error	FW type mismatch between the requested FW type and the FW type embedded in the FW binary header
		0x93	error	SVC call input parameter address violation
		0x94	error	Firmware Compatibility Level mismatch
		0x95	error	Bad status returned by I2CKnollCheck
		0x96	error	NACK to general call (no device on Knoll I2C bus)
		0x97	error	Null pointer passed to I2CKnollCheck
		0x98	error	Invalid device-ID found during Knoll authentication
		0x99	error	Error during Knoll/Prom key derivation
		0x9A	error	Null pointer passed to Crypto function
		0x9B	error	Error in checksum from wrapped Knoll/Prom keys
		0x9C	error	Knoll returned an invalid response to a command
		0x9D	error	Bootloader failed in Knoll Send Command function
		0x9E	error	No Knoll device found by verifying MAC
		0x9F	error	The maximum allowable error post code
		0xA0	error	Bootloader successfully entered C Main
		0xA1	error	Master initialized C2P / slave waited for master to init C2P
		0xA2	error	HMAC key successfully derived
		0xA3	error	Master got Boot Mode and sent boot mode to all slaves
		0xA4	error	SpiRom successfully initialized
		0xA5	error	BIOS Directory successfully read from SPI to SRAM
		0xA6	error	Early unlock check
		0xA7	error	Inline Aes key successfully derived
		0xA8	error	Inline-AES key programming is done
		0xA9	error	Inline-AES key wrapper derivation is done
		0xAA	error	Bootloader successfully loaded HW IP configuration values
		0xAB	error	Bootloader successfully programmed MBAT table
		0xAC	error	Bootloader successfully loaded SMU FW
		0xAD	error	Progress code is available
		0xAE	error	User mode test Uapp completed successfully
0xAF	error	Bootloader loaded Agesa0 from SpiRom		
0xB0	error	AGESA phase has completed		
0xB1	error	RunPostDramTrainingTests() completed successfully		
0xB2	error	SMU FW Successfully loaded to SMU Secure DRAM		
0xB3	error	Sent all required boot time messages to SMU		
0xB4	error	Validated and ran Security Gasket binary		
0xB5	error	UMC Keys generated and programmed		
0xB6	error	Inline AES key wrapper stored in DRAM		
0xB7	error	Completed FW Validation step		
0xB8	error	Completed FW Validation step		
0xB9	error	BIOS copy from SPI to DRAM complete		
0xBA	error	Completed FW Validation step		

(continued on the next page)

ACTION	PHASE	POST CODE	TYPE	DESCRIPTION
		0xBB	error	BIOS load process fully complete
		0xBC	error	Bootloader successfully release x86
		0xBD	error	Early Secure Debug completed
		0xBE	error	GetFWVersion command received from BIOS is completed
		0xBF	error	SMInfo command received from BIOS is completed
		0xC0	error	Successfully entered WarmBootResume()
		0xC1	error	Successfully copied SecureOS image to SRAM
		0xC2	error	Successfully copied trustlets to PSP Secure Memory
		0xC3	error	About to jump to Secure OS (SBL about to copy and jump)
		0xC4	error	Successfully restored CCP and UMC state on S3 resume
		0xC5	error	PSP SRAM HMAC validated by Mini BL
		0xC6	error	About to jump to <t-base in Mini BL
		0xC7	error	VMG ECDH unit test started
		0xC8	error	VMG ECDH unit test passed
		0xC9	error	VMG ECC CDH primitive unit test started
		0xCA	error	VMG ECC CDH primitive unit test passed
		0xCB	error	VMG SP800-108 KDF-CTR HMAC unit test started
		0xCC	error	VMG SP800-108 KDF-CTR HMAC unit test passed
		0xCD	error	VMG LAUNCH_* test started
		0xCE	error	VMG LAUNCH_* test passed
		0xCF	error	MP1 has been taken out of reset, and executing SMUFW
		0xD0	error	PSP and SMU Reserved Addresses correct
		0xD1	error	Reached Naples steady-state WFI loop
		0xD2	error	Knoll device successfully initialized
		0xD3	error	32-byte RandOut successfully returned from Knoll
		0xD4	error	32-byte MAC successfully received from Knoll.
		0xD5	error	Knoll device verified successfully
		0xD6	error	CNLI Keys generated and programmed
		0xD7	error	Enter recovery mode due to trustlet validation fail.
		0xD8	error	Enter recovery mode due to OS validation fail.
		0xD9	error	Enter recovery mode due to OEM public key not found.
		0xDA	error	Enter recovery mode with header corruption
		0xDB	error	We should not treat this error as blocking
		0xDC	error	When same fw image type is already loaded in SRAM
		0xDD	error	0xE2 progress codes are available
		0xE0	error	Unlock return
		0xE2	error	Token expiration reset triggered
		0xE3	error	Completed DXIO PHY SRAM FW key Validation step
		0xE4	error	MP1 firmware load to SRAM success
		0xE5	error	Bootloader read the MP1 SRAM successfully
		0xE6	error	Bootloader successfully reset MP1
		0xE7	error	DF init successfully done (in absence of AGESA)
		0xE8	error	UMC init successfully done (in absence of AGESA)
		0xE9	error	LX6 Boot ROM code ready
		0xEA	error	Bootloader successfully asserted LX6 reset
		0xEB	error	LX6 load to SRAM success
		0xEC	error	Bootloader successfully set LX6 reset vector to SRAM
		0xED	error	Bootloader successfully de-asserted LX6 reset
		0xEE	error	LX6 firmware is running and ready
		0xEF	error	Loading of S3 image done successfully
		0xF0	error	Bootloader successfully verify signed image using 4K/2K key
		0xF1	error	Bootloader identified as running on SP32P or multi-socket boot
		0xF2	error	Security Policy check successful (only in secure boot)
		0xF3	error	Bootloader successfully loaded SS3
		0xF4	error	Bootloader successfully load ITPM Driver
		0xF5	error	Bootloader successfully loaded sys_drv
		0xF6	error	Bootloader successfully loaded secure OS
		0xF7	error	Bootloader about to transfer control to secureOS
		0xFF	error	Bootloader sequence finished
		0x10	Progress	PEI Core Entry
		0x11	Progress	PEI cache as ram CPU initial
		0x15	Progress	NB Initialization before installed memory
		0x19	Progress	SB Initialization before installed memory
PSP Boot	PSP Boot Loader phase (Status Post Codes)			
Quick VGA	PEI(Pre-EFI Initialization) phase			

(continued on the next page)

ACTION	PHASE	POST CODE	TYPE	DESCRIPTION	
Quick VGA	DXE(Driver Execution Environment) phase	0x32	Progress	CPU POST-Memory Initialization	
		0x33	Progress	CPU Cache Initialization	
		0x34	Progress	Application Processor(s) (AP) Initialization	
		0x35	Progress	BSP Selection	
		0x36	Progress	CPU Initialization	
		0x37	Progress	Pre-memory NB Initialization	
		0x3B	Progress	Pre-memory SB Initialization	
		0x4F	Progress	DXE Initial Program Load(IPL)	
		0x60	Progress	DXE Core Started	
		0x61	Progress	DXE NVRAM Initialization	
		0x62	Progress	SB run-time Initialization	
		0x63	Progress	CPU DXE Initialization	
		0x68	Progress	PCI HB Initialization	
		0x69	Progress	NB DXE Initialization	
		0x6A	Progress	NB DXE SMM Initialization	
		0x70	Progress	SB DXE Initialization	
		0x71	Progress	SB DXE SMM Initialization	
0x72	Progress	SB DEVICES Initialization			
0x78	Progress	ACPI Module Initialization			
0xD0	Progress	CPU PM Structure Initialization			
Normal boot	BDS(Boot Device Selection) phase	0x90	Progress	BDS started	
		0x91	Progress	Connect device event	
		0x92	Progress	PCI Bus Enumeration	
		0x93	Progress	PCI Bus Enumeration	
		0x94	Progress	PCI Bus Enumeration	
		0x95	Progress	PCI Bus Enumeration	
		0x96	Progress	PCI Bus Enumeration	
		0x97	Progress	Console output connect event	
		0x98	Progress	Console input connect event	
		0x99	Progress	AMI Super IO start	
		0x9A	Progress	AMI USB Driver Initialization	
		0x9B	Progress	AMI USB Driver Initialization	
		0x9C	Progress	AMI USB Driver Initialization	
		0x9D	Progress	AMI USB Driver Initialization	
		0xb3	Progress	Reset system	
		0xb4	Progress	USB hotplug	
		0xb6	Progress	NVRAM clean up	
		0xb7	Progress	NVRAM configuration reset	
		0xA0	Progress	IDE, AHCI Initialization	
		0xA1	Progress	IDE, AHCI Initialization	
		0xA2	Progress	IDE, AHCI Initialization	
		0xA3	Progress	IDE, AHCI Initialization	
		0x00-0xFF	Progress	Wait BMC ready	
		0xA8	Progress	BIOS Setup Utility password verify	
		0xA9	Progress	BIOS Setup Utility start	
		0xAB	Progress	BIOS Setup Utility input wait	
		0xAD	Progress	Ready to boot event	
		Operating system phase	0xAA	Progress	APIC mode
			0xAC	Progress	PIC mode

## Notices

### Federal Communications Commission Statement

This device complies with Part 15 of the FCC Rules. Operation is subject to the following two conditions:

- This device may not cause harmful interference.
- This device must accept any interference received including interference that may cause undesired operation.

This equipment has been tested and found to comply with the limits for a Class A digital device, pursuant to part 15 of the FCC Rules. These limits are designed to provide reasonable protection against harmful interference when the equipment is operated in a commercial environment. This equipment generates, uses, and can radiate radio frequency energy and, if not installed and used in accordance with the instruction manual, may cause harmful interference to radio communications. Operation of this equipment in a residential area is likely to cause harmful interference in which case the user will be required to correct the interference at his own expense.

---

**NOTE:** The use of shielded cables for connection of the monitor to the graphics card is required to assure compliance with FCC regulations. Changes or modifications to this unit not expressly approved by the party responsible for compliance could void the user's authority to operate this equipment.

---

### Compliance Statement of Innovation, Science and Economic Development Canada (ISED)

This device complies with Innovation, Science and Economic Development Canada licence exempt RSS standard(s). Operation is subject to the following two conditions: (1) this device may not cause interference, and (2) this device must accept any interference, including interference that may cause undesired operation of the device.

CAN ICES(A)/NMB(A)

### Déclaration de conformité de Innovation, Sciences et Développement économique Canada (ISED)

Le présent appareil est conforme aux CNR d'Innovation, Sciences et Développement économique Canada applicables aux appareils radio exempts de licence. L'exploitation est autorisée aux deux conditions suivantes : (1) l'appareil ne doit pas produire de brouillage, et (2) l'utilisateur de l'appareil doit accepter tout brouillage radioélectrique subi, même si le brouillage est susceptible d'en compromettre le fonctionnement.

CAN ICES(A)/NMB(A)

## Australia statement notice

From 1 January 2012 updated warranties apply to all ASUS products, consistent with the Australian Consumer Law. For the latest product warranty details please visit <https://www.asus.com/support/>. Our goods come with guarantees that cannot be excluded under the Australian Consumer Law. You are entitled to a replacement or refund for a major failure and compensation for any other reasonably foreseeable loss or damage. You are also entitled to have the goods repaired or replaced if the goods fail to be of acceptable quality and the failure does not amount to a major failure.

If you require assistance please call ASUS Customer Service 1300 2787 88 or visit us at <https://www.asus.com/support/>.



---

DO NOT throw the motherboard in municipal waste. This product has been designed to enable proper reuse of parts and recycling. This symbol of the crossed out wheeled bin indicates that the product (electrical and electronic equipment) should not be placed in municipal waste. Check local regulations for disposal of electronic products.

---



---

DO NOT throw the mercury-containing button cell battery in municipal waste. This symbol of the crossed out wheeled bin indicates that the battery should not be placed in municipal waste.

---

## Declaration of compliance for product environmental regulation

ASUS follows the green design concept to design and manufacture our products, and makes sure that each stage of the product life cycle of ASUS product is in line with global environmental regulations. In addition, ASUS disclose the relevant information based on regulation requirements.

Please refer to <https://esg.asus.com/Compliance.htm> for information disclosure based on regulation requirements ASUS is complied with:

### EU REACH and Article 33

Complying with the REACH (Registration, Evaluation, Authorization, and Restriction of Chemicals) regulatory framework, we publish the chemical substances in our products at ASUS REACH website at <https://esg.asus.com/Compliance.htm>.

## **EU RoHS**

This product complies with the EU RoHS Directive. For more details, see <https://esg.asus.com/Compliance.htm>

## **Japan JIS-C-0950 Material Declarations**

Information on Japan RoHS (JIS-C-0950) chemical disclosures is available on <https://esg.asus.com/Compliance.htm>

## **India RoHS**

This product complies with the “India E-Waste (Management) Rules, 2016” and prohibits use of lead, mercury, hexavalent chromium, polybrominated biphenyls (PBBs) and polybrominated diphenyl ethers (PBDEs) in concentrations exceeding 0.1% by weight in homogenous materials and 0.01% by weight in homogenous materials for cadmium, except for the exemptions listed in Schedule II of the Rule.

## **Vietnam RoHS**

ASUS products sold in Vietnam, on or after September 23, 2011, meet the requirements of the Vietnam Circular 30/2011/TT-BCT.

Các sản phẩm ASUS bán tại Việt Nam, vào ngày 23 tháng 9 năm 2011 trở về sau, đều phải đáp ứng các yêu cầu của Thông tư 30/2011/TT-BCT của Việt Nam.

## **Türkiye RoHS**

AEEE Yönetmeliğine Uygundur

## **ASUS Recycling/Takeback Services**

ASUS recycling and takeback programs come from our commitment to the highest standards for protecting our environment. We believe in providing solutions for you to be able to responsibly recycle our products, batteries, other components as well as the packaging materials. Please go to <https://esg.asus.com/en/Takeback.htm> for detailed recycling information in different regions.

## **Ecodesign Directive**

The European Union announced a framework for the setting of ecodesign requirements for energy-related products (2009/125/EC). Specific implementing measures are aimed at improving environmental performance of specific products or across multiple product types. ASUS provides product information at <https://esg.asus.com/Compliance.htm>.

## インターネット回線への接続に関するご注意

本製品は電気通信事業者（移动通信会社、固定通信会社、インターネットプロバイダ等）の通信回線（公衆無線LANを含む）に直接接続することができません。本製品をインターネットに接続する場合は、必ずルーター等を経由し接続してください。

## Japan statement notice

This product cannot be directly connected to the Internet (including public wireless LAN) of a telecom carrier (mobile network companies, landline network companies, Internet providers, etc.). When connecting this product to the Internet, be sure to connect it through a router or switch.

## Safety Precautions

Accessories that came with this product have been designed and verified for the use in connection with this product. Never use accessories for other products to prevent the risk of electric shock or fire.

## 安全上のご注意

付属品は当該専用品です。他の機器には使用しないでください。機器の破損もしくは、火災や感電の原因となることがあります。

## Access Advance Patent Notice



## Simplified EU Declaration of Conformity

**English** ASUSTeK Computer Inc. hereby declares that this device is in compliance with the essential requirements and other relevant provisions of related Directives. Full text of EU declaration of conformity is available at: [www.asus.com/support](http://www.asus.com/support)

**Français** AsusTek Computer Inc. déclare par la présente que cet appareil est conforme aux critères essentiels et autres clauses pertinentes des directives concernées. La déclaration de conformité de l'UE peut être téléchargée à partir du site Internet suivant : [www.asus.com/support](http://www.asus.com/support)

**Deutsch** ASUSTeK Computer Inc. erklärt hiermit, dass dieses Gerät mit den wesentlichen Anforderungen und anderen relevanten Bestimmungen der zugehörigen Richtlinien übereinstimmt. Der gesamte Text der EU-Konformitätserklärung ist verfügbar unter: [www.asus.com/support](http://www.asus.com/support)

**Italiano** ASUSTeK Computer Inc. con la presente dichiara che questo dispositivo è conforme ai requisiti essenziali e alle altre disposizioni pertinenti con le direttive correlate. Il testo completo della dichiarazione di conformità UE è disponibile all'indirizzo: [www.asus.com/support](http://www.asus.com/support)

**Русский** Компания ASUS заявляет, что это устройство соответствует основным требованиям и другим соответствующим условиям соответствующих директив. Подробную информацию, пожалуйста, смотрите на [www.asus.com/support](http://www.asus.com/support)

**Български** С настоящото ASUSTeK Computer Inc. декларира, че това устройство е в съответствие със съществените изисквания и другите приложими постановления на свързаните директиви. Пълният текст на декларацията за съответствие на ЕС е достъпна на адрес: [www.asus.com/support](http://www.asus.com/support)

**Hrvatski** ASUSTeK Computer Inc. ovim izjavljuje da je ovaj uređaj sukladan s bitnim zahtjevima i ostalim odgovarajućim odredbama vezanih direktiva. Cijeli tekst EU izjave o sukladnosti dostupan je na: [www.asus.com/support](http://www.asus.com/support)

**Čeština** Společnost ASUSTeK Computer Inc. tímto prohlašuje, že toto zařízení splňuje základní požadavky a další příslušná ustanovení souvisejících směrnic. Plné znění prohlášení o shodě EU je k dispozici na adrese: [www.asus.com/support](http://www.asus.com/support)

**Dansk** ASUSTeK Computer Inc. erklærer hermed, at denne enhed er i overensstemmelse med hovedkravene og andre relevante bestemmelser i de relaterede direktiver. Hele EU-overensstemmelseserklæringen kan findes på: [www.asus.com/support](http://www.asus.com/support)

**Nederlands** ASUSTeK Computer Inc. verklaart hierbij dat dit apparaat voldoet aan de essentiële vereisten en andere relevante bepalingen van de verwante richtlijnen. De volledige tekst van de EU-verklaring van conformiteit is beschikbaar op: [www.asus.com/support](http://www.asus.com/support)

**Eesti** Käesolevaga kinnitab ASUSTeK Computer Inc, et see seade vastab asjakohaste direktiivide oluliste nõuetele ja teistele asjassepuutuvatele sätetele. EL vastavusdeklaratsiooni täielik tekst on saadaval järgmisel aadressil: [www.asus.com/support](http://www.asus.com/support)

**Suomi** ASUSTeK Computer Inc. ilmoittaa täten, että tämä laite on asiaankuuluvien direktiivien olennaisten vaatimusten ja muiden tätä koskevien säädösten mukainen. EU-yhdenmukaisuusilmoituksen koko teksti on luettavissa osoitteessa: [www.asus.com/support](http://www.asus.com/support)

**Ελληνικά** Με το παρόν, η AsusTek Computer Inc. δηλώνει ότι αυτή η συσκευή συμμορφώνεται με τις θεμελιώδεις απαιτήσεις και άλλες σχετικές διατάξεις των Οδηγιών της ΕΕ. Το πλήρες κείμενο της δήλωσης συμβατότητας είναι διαθέσιμο στη διεύθυνση: [www.asus.com/support](http://www.asus.com/support)

**Magyar** Az ASUSTeK Computer Inc. ezennel kijelenti, hogy ez az eszköz megfelel a kapcsolódó Irányelvek lényeges követelményeinek és egyéb vonatkozó rendelkezéseinek. Az EU megfelelésségi nyilatkozat teljes szövege innen letölthető: [www.asus.com/support](http://www.asus.com/support)



**Latviski** ASUSTeK Computer Inc. ar šo paziņo, ka šī ierīce atbilst saistīto Direktīvu būtiskajām prasībām un citiem citiem saistošajiem nosacījumiem. Pilns ES atbilstības paziņojuma teksts pieejams šeit: [www.asus.com/support](http://www.asus.com/support)

**Lietuvių** „ASUSTeK Computer Inc.” šiuo tvirtina, kad šis įrenginys atitinka pagrindinius reikalavimus ir kitas svarbias susijusių direktyvų nuostatas. Visą ES atitikties deklaracijos tekstą galima rasti: [www.asus.com/support](http://www.asus.com/support)

**Norsk** ASUSTeK Computer Inc. erklærer herved at denne enheten er i samsvar med hovedsaklige krav og andre relevante forskrifter i relaterte direktiver. Fullstendig tekst for EU-samsvarserklæringen finnes på: [www.asus.com/support](http://www.asus.com/support)

**Polski** Firma ASUSTeK Computer Inc. niniejszym oświadcza, że urządzenie to jest zgodne z zasadniczymi wymogami i innymi właściwymi postanowieniami powiązanych dyrektyw. Pełny tekst deklaracji zgodności UE jest dostępny pod adresem: [www.asus.com/support](http://www.asus.com/support)

**Português** A ASUSTeK Computer Inc. declara que este dispositivo está em conformidade com os requisitos essenciais e outras disposições relevantes das Diretivas relacionadas. Texto integral da declaração da UE disponível em: [www.asus.com/support](http://www.asus.com/support)

**Română** ASUSTeK Computer Inc. declară că acest dispozitiv se conformează cerințelor esențiale și altor prevederi relevante ale directivelor conexe. Textul complet al declarației de conformitate a Uniunii Europene se găsește la: [www.asus.com/support](http://www.asus.com/support)

**Srpski** ASUSTeK Computer Inc. ovim izjavljuje da je ovaj uređaj u saglasnosti sa osnovnim zahtevima i drugim relevantnim odredbama povezanih Direktiva. Pun tekst EU deklaracije o usaglašenosti je dostupan da adresi: [www.asus.com/support](http://www.asus.com/support)

**Slovensky** Spoločnosť ASUSTeK Computer Inc. týmto vyhlasuje, že toto zariadenie vyhovuje základným požiadavkám a ostatným príslušným ustanoveniam príslušných smerníc. Celý text vyhlásenia o zhode pre štáty EÚ je dostupný na adrese: [www.asus.com/support](http://www.asus.com/support)

**Slovenščina** ASUSTeK Computer Inc. izjavlja, da je ta naprava skladna z bistvenimi zahtevami in drugimi ustreznimi določbami povezanih direktiv. Celotno besedilo EU-izjave o skladnosti je na voljo na spletnem mestu: [www.asus.com/support](http://www.asus.com/support)

**Español** Por la presente, ASUSTeK Computer Inc. declara que este dispositivo cumple los requisitos básicos y otras disposiciones pertinentes de las directivas relacionadas. El texto completo de la declaración de la UE de conformidad está disponible en: [www.asus.com/support](http://www.asus.com/support)

**Svenska** ASUSTeK Computer Inc. förklarar härmed att denna enhet överensstämmer med de grundläggande kraven och andra relevanta föreskrifter i relaterade direktiv. Fulltext av EU-försäkran om överensstämmelse finns på: [www.asus.com/support](http://www.asus.com/support)

**Українська** ASUSTeK Computer Inc. заявляє, що цей пристрій відповідає основним вимогам та іншим відповідним положенням відповідних Директив. Повний текст декларації відповідності стандартам ЄС доступний на: [www.asus.com/support](http://www.asus.com/support)

**Türkçe** AsusTek Computer Inc., bu aygıtın temel gereksinimlerle ve ilişkili Yönergelerin diğer ilgili koşullarıyla uyumlu olduğunu beyan eder. AB uygunluk bildiriminin tam metni şu adreste bulunabilir: [www.asus.com/support](http://www.asus.com/support)

**Bosanski** ASUSTeK Computer Inc. ovim izjavljuje da je ovaj uređaj usklađen sa bitnim zahtjevima i ostalim odgovarajućim odredbama vezanih direktiva. Cijeli tekst EU izjave o usklađenosti dostupan je na: [www.asus.com/support](http://www.asus.com/support)

## Simplified UKCA Declaration of Conformity

ASUSTeK Computer Inc. hereby declares that this device is in compliance with the essential requirements and other relevant provisions of related Regulations. Full text of UKCA declaration of conformity is available at: [www.asus.com/support](http://www.asus.com/support)

# FCC COMPLIANCE INFORMATION

Per FCC Part 2 Section 2.1077



**Responsible Party:** Asus Computer International  
**Address:** 48720 Kato Rd., Fremont, CA 94538  
**Phone/Fax No:** (510)739-3777/(510)608-4555

hereby declares that the product

**Product Name :** Server  
**Model Number :** RS700A-E13-RS12U, RS700A-E13-RS4U

**compliance statement:**

This device complies with part 15 of the FCC Rules. Operation is subject to the following two conditions: (1) This device may not cause harmful interference, and (2) this device must accept any interference received, including interference that may cause undesired operation.

Ver. 180125

## Service and Support

Visit our multi-language website at <https://www.asus.com/support>.

