



GS1200v3 Series

5-Port/8-Port GbE Web Managed Switch

The GS1200 Series Web Managed Gigabit Switch provides simple control for better management. Unlike other advanced but complex managed switches, this series of switch is suitable for most users and provides an affordable solution with essential features including VLAN, QoS, IGMP snooping, link aggregation, and port mirroring. These functions can be completed in just a few simple clicks through an easy, friendly, and intuitive Web GUI.

There are five models for GS1200 series, coming with non-PoE (GS1200-5v3/8v3) to connect to devices including PCs, NAS, and print servers, PoE capable (GS1200-5HPv3/8HPv3) to provide power to IP CAM, wall mounted AP and PoE standard devices, and fiber uplink (GS1200-10v3) for easily deployment in hallways to connect network devices on the same floor and link them back to the core network.



Easy web management



PoE model supports 802.3at, with PoE availability up to 68W



Supports link aggregation, QoS and multicast IGMP snooping



Virtual LAN for enhanced network security



Design with fanless and LED ECO mode for disturbance free operation experience



Advanced energy-savings at work

Easy web management

This switch caters to most users and is an affordable solution with essential features including VLAN, QoS, IGMP snooping v1/v2 and v3 compatible, link aggregation, and port mirroring. These smart features are easily configurable through a user-friendly web-based interface. It's the most ideal solution to simplify networks for home and small office users.



Smart PoE+ support

The GS1200 PoE models support the IEEE 802.3at PoE+, providing a maximum of 30 watts per port (with a max total power budget of 68 watts) to supply power to PoE network devices like wireless APs, IP cameras and VoIP phones. Web GUI management enables you to monitor the power status on each port and/or reboot the network devices, as needed.



Quality of Service

Port-based Quality of Service for better voice and video traffic control. Optimizing access bandwidth on the network.



Link aggregation

Increases bandwidth by aggregating two Ethernet ports, using Link Aggregation Control Protocol (LACP) to dynamically manage and optimize the combined uplink/downlink traffic for improved network performance and redundancy.

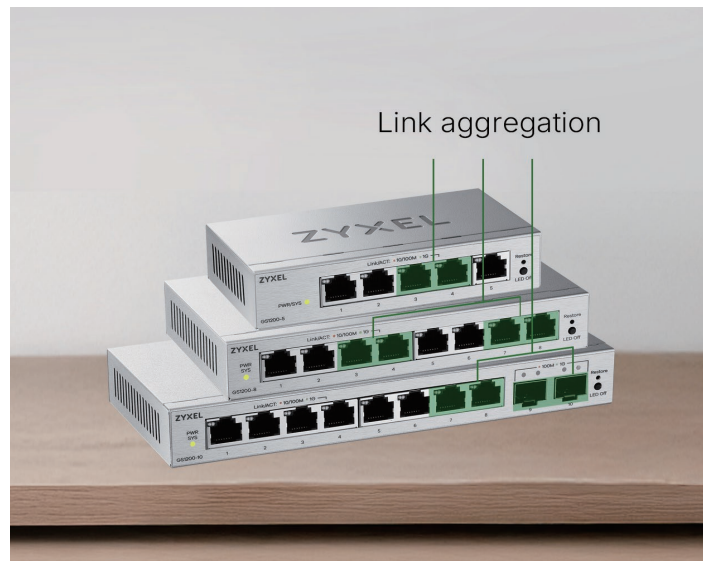

VLAN

Segregating network into small groups for enhanced network security and efficiency.



IGMP snooping

Optimizing network efficiency on multicast traffic delivery without the need of an extra multicast router.



Experience whisper-silent and energy-saving operations

Compliant with the IEEE 802.3az Energy Efficient Ethernet standard, the GS1200 Switch offers power-saving benefits by detecting link status and consuming power more efficiently. The fanless design ensures all-time silent operation to blend into noise-free working environments. Also, you can deactivate the Ethernet port LEDs for distraction-free operation by switching to LED ECO mode through the front panel button or the web-based interface.



Model List

GS1200-5v3

5-Port GbE Web Managed Switch



- 5 x GbE RJ-45 ports

GS1200-5HPv3

5-Port GbE PoE Web Managed Switch



- 4 x GbE PoE+ RJ-45 ports
- 1 x GbE RJ-45 port
- PoE power budget: 68W

GS1200-8v3

8-Port GbE Web Managed Switch



- 8 x GbE RJ-45 ports

GS1200-8HPv3

8-Port GbE PoE Web Managed Switch



- 4 x GbE PoE+ RJ-45 ports
- 4 x GbE RJ-45 ports
- PoE power budget: 68W

GS1200-10v3

8-Port GbE Web Managed Switch with 2 GbE Uplink





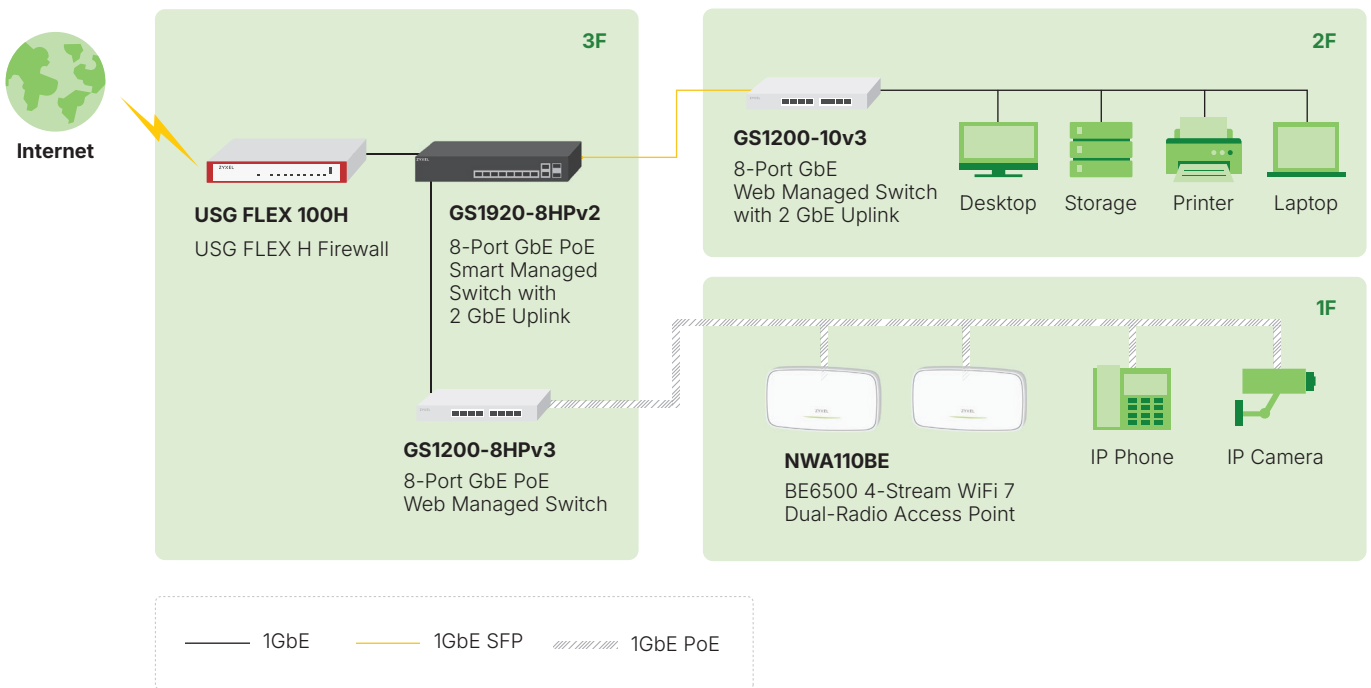

- 8 x GbE RJ-45 ports
- 2 x GbE SFP ports

Application Diagram

Standalone Management



Specifications

Model	GS1200-5v3	GS1200-5HPv3	GS1200-8v3	GS1200-8HPv3	GS1200-10v3	
Product name	5-Port GbE Web Managed Switch	5-Port GbE PoE Web Managed Switch	8-Port GbE Web Managed Switch	8-Port GbE PoE Web Managed Switch	8-Port GbE Web Managed Switch with 2 GbE Uplink	
						
Switch class	Web Managed	Web Managed	Web Managed	Web Managed	Web Managed	
Port Density						
Total port count	5	5	8	8	10	
10M/100M/1G (RJ-45)	5	5	8	8	8	
Gigabit SFP	-	-	-	-	2	
PoE						
PoE ports	-	4	-	4	-	
Total PoE budget (watts)	-	68	-	68	-	
IEEE 802.3at (PoE+)	-	Yes	-	Yes	-	
Performance						
Switching capacity (Gbps)	10	10	16	16	20	
Forwarding rate (Mpps)	7.44	7.44	11.9	11.9	14.88	
Packet buffer (byte)	192 KB	192 KB	192 KB	192 KB	192 KB	
MAC address table	4 K	4 K	4 K	4 K	4 K	
Jumbo frame (byte)	15 KB	15 KB	15 KB	15 KB	15 KB	
Power						
Input	100 - 240 V AC, 50/60 Hz	100 - 240 V AC, 50/60 Hz	100 to 240 V AC, 50/60 Hz	100 to 240 V AC, 50/60 Hz	100 to 240 V AC, 50/60 Hz	
Power supply	External	External	External	External	External	
Min. power consumption (watts) Without any port connection	0.722	1.779	0.58	1.54	0.939	
Max. power consumption (watts) All ports full load without PoE	2.718	4.153	3.81	4.7	4.165	
Max. power consumption (watts) All ports full load with PoE	-	81.126	-	81.27	-	
Physical Specifications						
Item	Dimensions (WxDxH) (mm/in.)	121 × 75 × 26/ 4.76 × 2.95 × 1.02	155 × 85 × 26/ 6.1 × 3.35 × 1.02	155 × 85 × 26/ 6.1 × 3.35 × 1.02	193 × 85 × 26/ 7.6 × 3.35 × 1.02	193 × 85 × 26/ 7.6 × 3.35 × 1.02
	Weight (kg/lb.)	0.172/0.38	0.274/0.6	0.268/0.59	0.337/0.74	0.338/0.75
Green Feature						
Energy-Efficient Ethernet	Yes	Yes	Yes	Yes	Yes	
Environmental Specifications						
Operating	Temperature	0°C to 40°C/ 32°F to 104°F	0°C to 40°C/ 32°F to 104°F	0°C to 40°C/ 32°F to 104°F	0°C to 40°C/ 32°F to 104°F	0°C to 50°C/ 32°F to 122°F
	Humidity	10% to 95% (non-condensing)	10% to 95% (non-condensing)	10% to 95% (non-condensing)	10% to 95% (non-condensing)	10% to 95% (non-condensing)
Storage	Temperature	-40°C to 70°C/ -40°F to 158°F	-40°C to 70°C/ -40°F to 158°F	-40°C to 70°C/ -40°F to 158°F	-40°C to 70°C/ -40°F to 158°F	-40°C to 70°C/ -40°F to 158°F
	Humidity	10% to 95% (non-condensing)	10% to 95% (non-condensing)	10% to 95% (non-condensing)	10% to 95% (non-condensing)	10% to 95% (non-condensing)
MTBF (hr @ 25°C)		1,375,342	1,730,334	1,266,805	1,749,682	909,732
Heat dissipation (BTU/hr)		9.274	44.788	13	45.279	14.212
Acoustic noise @ 25°C (min/max, dBA)		Fanless, 0	Fanless, 0	Fanless, 0	Fanless, 0	Fanless, 0

Features

Standard

- IEEE 802.3 10BASE-T Ethernet
- IEEE 802.3u 100BASE-TX Ethernet
- IEEE 802.3ab 1000BASE-T Ethernet
- IEEE 802.3 Nway auto-negotiation
- IEEE 802.3x full duplex operation and flow control
- IEEE 802.3az Energy Efficient Ethernet
- IEEE 802.1Q VLAN tagging
- IEEE 802.3ad LACP
- IEEE 802.1p QoS
- IEEE 802.3af PoE (PoE models)
- IEEE 802.3at PoE Plus (PoE models)

Features

- Web-based management
- Auto-MDI/MDIX in all ports
- System password
- Port-based QoS
- Broadcast storm control
- Loop prevention
- DHCP client
- Static/LACP Link aggregation
 - GS1200-5v3/5HPv3: one LAG (Port 3&4)
 - GS1200-8v3/8HPv3: two LAGs (Port 3&4, Port 7&8)
 - GS1200-10v3: (Port 7&8, Port 9&10)
- Port mirroring
- Weighted Round Robin (WRR) priority QoS
- IGMP snooping v1/v2/and v3 compatible
- Supported multicast groups: 128
- Support Zyxel One Network (ZON Utility)
- Ethernet port LED on/off

LED Indicator

- PWR: Power
- LINK/ACT
 - Green: 1000 Mbps
 - Amber: 10/100 Mbps
- PoE Max (PoE models only):
 - Unlit: Supply PoE-enabled devices less than 60W
 - Amber: Supply PoE-enabled devices more than 60W
- PoE (PoE models only):
 - Green: PoE is enabled and power is supplied
 - Unlit: PoE is disabled or power is not being supplied

Certifications

- Safety: CE-LVD, BSMI
- EMC: CE, EAC, FCC, BSMI Class B

Package Contents

- Switch
- Power adapter
- Power cord (for PoE models)
- SFP cover (for GS1200-10v3)
- Rubber pad
- Safety warning and doc

Accessories

Transceivers (Optional)

Model	Speed	Connector	Wavelength	Max. Distance	DDMI
SFP-1000T	Gigabit	RJ-45	-	0.1 km (109 yd)	-
SFP-SX-D	Gigabit	Duplex LC	850 nm	0.55 km (601 yd)	Yes
SFP-SX-D-E	Gigabit	Duplex LC	850 nm	0.55 km (601 yd)	Yes
SFP-LX-10-D	Gigabit	Duplex LC	1310 nm	10 km (10936 yd)	Yes
SFP-LX-10-E	Gigabit	Duplex LC	1310 nm	10 km (10936 yd)	Yes
SFP-LHX1310-40-D	Gigabit	Duplex LC	1310 nm	40 km (43744 yd)	Yes
SFP-ZX-80-D	Gigabit	Duplex LC	1550 nm	80 km (87488 yd)	Yes
SFP-BX1310-10-D	Gigabit	Single LC	1310 nm (Tx) 1490 nm (Rx)	10 km (10936 yd)	Yes
SFP-BX1310-E	Gigabit	Single LC	1310 nm (Tx) 1550 nm (Rx)	20 km (21872 yd)	Yes
SFP-BX1490-10-D	Gigabit	Single LC	1490 nm (Tx) 1310 nm (Rx)	10 km (10936 yd)	Yes
SFP-BX1550-E	Gigabit	Single LC	1550 nm (Tx) 1310 nm (Rx)	20 km (21872 yd)	Yes

Ordering Information

Model	EAN	PN
GS1200-5v3	4718937649853	GS1200-5v3-EU0101F
	4718937649860	GS1200-5v3-GB0101F
	4718937654505	GS1200-5V3-USAM01F
	4718937649884	GS1200-5v3-US0101F
	4718937649877	GS1200-5v3-TW0101F
GS1200-8v3	4718937649945	GS1200-8v3-EU0101F
	4718937649952	GS1200-8v3-GB0101F
	4718937654529	GS1200-8V3-USAM01F
	4718937649976	GS1200-8v3-US0101F
	4718937649969	GS1200-8v3-TW0101F
GS1200-10v3	4718937649761	GS1200-10V3-EU0101F
	4718937649778	GS1200-10V3-GB0101F
	4718937654482	GS1200-10V3-USAM01F
	4718937649792	GS1200-10V3-US0101F
	4718937649785	GS1200-10V3-TW0101F
GS1200-5HPv3	4718937649815	GS1200-5HPV3-EU0101F
	4718937652105	GS1200-5HPV3-GB0101F
	4718937654499	GS1200-5HPV3-USAM01F
	4718937649839	GS1200-5HPV3-US0101F
	4718937649822	GS1200-5HPV3-TW0101F
GS1200-8HPv3	4718937649907	GS1200-8HPV3-EU0101F
	4718937652112	GS1200-8HPV3-GB0101F
	4718937654512	GS1200-8HPV3-USAM01F
	4718937649921	GS1200-8HPV3-US0101F
	4718937649914	GS1200-8HPV3-TW0101F

For more product information, visit us on the web at www.zyxel.com

Copyright © 2026 Zyxel and/or its affiliates. All rights reserved.
All specifications are subject to change without notice.



08/01/26