

**Pro WS  
W890E-SAGE  
SE**

**ASUS**

**Motherboard**

E26993  
First Edition  
March 2026

**Copyright © 2026 ASUSTeK COMPUTER INC. All Rights Reserved.**

No part of this manual, including the products and software described in it, may be reproduced, transmitted, transcribed, stored in a retrieval system, or translated into any language in any form or by any means, except documentation kept by the purchaser for backup purposes, without the express written permission of ASUSTeK COMPUTER INC. ("ASUS").

Product warranty or service will not be extended if: (1) the product is repaired, modified or altered, unless such repair, modification or alteration is authorized in writing by ASUS; or (2) the serial number of the product is defaced or missing.

ASUS PROVIDES THIS MANUAL "AS IS" WITHOUT WARRANTY OF ANY KIND, EITHER EXPRESS OR IMPLIED, INCLUDING BUT NOT LIMITED TO THE IMPLIED WARRANTIES OR CONDITIONS OF MERCHANTABILITY OR FITNESS FOR A PARTICULAR PURPOSE. IN NO EVENT SHALL ASUS, ITS DIRECTORS, OFFICERS, EMPLOYEES OR AGENTS BE LIABLE FOR ANY INDIRECT, SPECIAL, INCIDENTAL, OR CONSEQUENTIAL DAMAGES (INCLUDING DAMAGES FOR LOSS OF PROFITS, LOSS OF BUSINESS, LOSS OF USE OR DATA, INTERRUPTION OF BUSINESS AND THE LIKE), EVEN IF ASUS HAS BEEN ADVISED OF THE POSSIBILITY OF SUCH DAMAGES ARISING FROM ANY DEFECT OR ERROR IN THIS MANUAL OR PRODUCT.

SPECIFICATIONS AND INFORMATION CONTAINED IN THIS MANUAL ARE FURNISHED FOR INFORMATIONAL USE ONLY, AND ARE SUBJECT TO CHANGE AT ANY TIME WITHOUT NOTICE, AND SHOULD NOT BE CONSTRUED AS A COMMITMENT BY ASUS. ASUS ASSUMES NO RESPONSIBILITY OR LIABILITY FOR ANY ERRORS OR INACCURACIES THAT MAY APPEAR IN THIS MANUAL, INCLUDING THE PRODUCTS AND SOFTWARE DESCRIBED IN IT.

Products and corporate names appearing in this manual may or may not be registered trademarks or copyrights of their respective companies, and are used only for identification or explanation and to the owners' benefit, without intent to infringe.

# Contents

Safety information.....	5
About this guide.....	7
Pro WS W890E-SAGE SE specifications summary .....	9
Package contents.....	15
Connectors with shared bandwidth .....	16
<b>Chapter 1: Product Introduction</b>	
1.1 Before you proceed .....	17
1.2 Motherboard layout.....	18
1.3 Motherboard rear and audio connections .....	43
1.3.1 Rear I/O connection.....	43
1.3.2 LAN port LEDs .....	44
1.3.3 Audio I/O connections.....	44
<b>Chapter 2: Basic Setup</b>	
2.1 CPU installation .....	48
2.2 DIMM installation .....	52
2.3 M.2 module installation .....	53
2.4 Additional cooling kit installation .....	64
2.5 Motherboard installation.....	65
2.6 Power connection.....	66
2.7 USB4® monitor connection .....	67
2.8 BIOS FlashBack™ .....	69
2.9 Clear CMOS button.....	70
2.10 Starting up for the first time .....	71
2.11 Turning off the computer.....	71
<b>Chapter 3: BIOS and RAID Support</b>	
3.1 Knowing UEFI BIOS.....	72
3.2 ASUS EZ Flash Utility.....	73
3.3 ASUS CrashFree BIOS 3 .....	74
3.4 RAID configurations .....	75
<b>Appendix</b>	
Pro WS W890E-SAGE SE block diagram.....	76
Q-Code table .....	77
General notices.....	81
Notices for non Wi-Fi model .....	84
Warranty.....	86
ASUS contact information .....	89

Service and support ..... 89  
Product register ..... 89

# Safety information

## Electrical safety

- To prevent electrical shock hazard, disconnect the power cable from the electrical outlet before relocating the system.
- When adding or removing devices to or from the system, ensure that the power cables for the devices are unplugged before the signal cables are connected. If possible, disconnect all power cables from the existing system before you add a device.
- Before connecting or removing signal cables from the motherboard, ensure that all power cables are unplugged.
- Seek professional assistance before using an adapter or extension cord. These devices could interrupt the grounding circuit.
- Ensure that your power supply is set to the correct voltage in your area. If you are not sure about the voltage of the electrical outlet you are using, contact your local power company.
- If the power supply is broken, do not try to fix it by yourself. Contact a qualified service technician or your retailer.

## Operation safety

- Before installing the motherboard and adding devices on it, carefully read all the manuals that came with the package.
- Before using the product, ensure all cables are correctly connected and the power cables are not damaged. If you detect any damage, contact your dealer immediately.
- To avoid short circuits, keep paper clips, screws, and staples away from connectors, slots, sockets and circuitry.
- Avoid dust, humidity, and temperature extremes. Do not place the product in any area where it may become wet.
- Place the product on a stable surface.
- If you encounter technical problems with the product, contact a qualified service technician or your retailer.
- Your motherboard should only be used in environments with ambient temperatures between 10°C and 35°C.
- When removing motherboard components or installing other devices, be sure to handle with care. We recommend wearing gloves or other protective gear to prevent injuries to yourself.

## Button/Coin Batteries Safety Information

1. Remove and immediately recycle or dispose of used batteries according to local regulations and keep out of reach of children. Do not incinerate or dispose of batteries in household trash.
2. If ingested or inserted inside any part of the body, call a local poison control center for treatment information. Even used batteries may cause serious injury or death.
3. This product uses CR2032 type batteries with a nominal voltage of 3V.
4. Do not attempt to recharge non-rechargeable batteries.
5. Do not forcibly discharge, recharge, disassemble, heat above the battery manufacturer's specified temperature rating, or incinerate. Doing so may result in injury or chemical burns caused by venting, leakage, or explosion.
6. This product contains non-replaceable batteries.

<b>⚠ WARNING</b>	
<ul style="list-style-type: none"><li>• <b>INGESTION HAZARD:</b> This product contains a button cell or coin battery.</li><li>• <b>DEATH</b> or serious injury can occur if ingested.</li><li>• A swallowed button cell or coin battery can cause <b>Internal Chemical Burns</b> in as little as <b>2 hours</b>.</li><li>• <b>KEEP</b> new and used batteries <b>OUT OF REACH of CHILDREN</b>.</li><li>• <b>Seek immediate medical attention</b> if a battery is suspected to be swallowed or inserted inside any part of the body.</li></ul>	

## About this guide

This user guide contains the information you need when installing and configuring the motherboard.

## How this guide is organized

This guide contains the following parts:

- **Chapter 1: Product Introduction**  
This chapter describes the features of the motherboard and includes descriptions for each part of the motherboard.
- **Chapter 2: Basic Setup**  
This chapter lists the basic setup procedures for setting up your motherboard.
- **Chapter 3: BIOS and RAID Support**  
This chapter tells how to boot into the BIOS, upgrade BIOS using the EZ Flash Utility and support on RAID.

## Where to find more information

Refer to the following sources for additional information and for product and software updates.

1. **ASUS website**  
The ASUS website ([www.asus.com](http://www.asus.com)) provides updated information on ASUS hardware and software products.
2. **Optional documentation**  
Your product package may include optional documentation, such as warranty flyers, that may have been added by your dealer. These documents are not part of the standard package.
3. **Motherboard Installation Guide**  
Please visit <https://www.asus.com/support> for more information on the Motherboard Installation Guide.



#### 4. Driver and Utilities FAQ

Please visit <https://www.asus.com/support> for more information on downloading and installing drivers and utilities for your motherboard.



#### 5. RAID Configuration Guide

Please visit <https://www.asus.com/support> for more information on the RAID Configuration Guide.



#### 6. BIOS FlashBack™ Feature

Please visit <https://www.asus.com/support> for more information on the BIOS FlashBack™ Feature.



## Conventions used in this guide

To ensure that you perform certain tasks properly, take note of the following notes used throughout this user guide.

<b>CAUTION</b>	Information to prevent damage to the components and injuries to yourself when trying to complete a task.
<b>IMPORTANT</b>	Instructions that you <b>MUST</b> follow to complete a task.
<b>NOTE</b>	Tips and additional information to help you complete a task.

## Pro WS W890E-SAGE SE specifications summary

CPU	<p>Intel® Socket LGA4710-2 for Xeon® 600 Processors for Workstation Supports Intel® Turbo Boost Technology 2.0 and Intel® Turbo Boost Max Technology 3.0**</p> <p>* Refer to <a href="https://www.asus.com/support/download-center/">https://www.asus.com/support/download-center/</a> for CPU support list. ** Intel® Turbo Boost Max Technology 3.0 support depends on the CPU types.</p>
Chipset	Intel® W890
Memory	<p>8 x DIMM slots, DDR5, ECC Registered DIMM (RDIMM), 3DS-RDIMM, and Multiplexed Combined Rank DIMM (MRDIMM)*</p> <p>8-channel memory architecture</p> <p>Supports Intel® Extreme Memory Profile (XMP) memory module</p> <p>* Only channels A, C, E, and G will function when an Intel® Xeon® 630 Series Processor is in use.</p> <p>** Supported memory types, data rate (speed), and number of DRAM modules vary depending on the CPU and memory configuration, for more information please refer to CPU/Memory Support list under the Support tab of product information site or visit <a href="https://www.asus.com/support/download-center/">https://www.asus.com/support/download-center/</a>. Adjustments will be made based on the specifications of mass-produced memory products available on the market.</p>
Graphics	<p>1 x VGA port from AST2600</p> <p>2 x USB4® (40Gbps) ports support USB Type-C® display output</p> <p>* Supports max. 8K@60Hz as specified in DisplayPort 1.4.</p> <p>** Output at USB4® (40Gbps) Type-C® port 1 or USB4® (40Gbps) Type-C® port 2 each require a Mini DisplayPort IN to DisplayPort adapter cable. For more information on display connection and video output configuration using the Mini DisplayPort IN ports, please refer to the user manual.</p> <p>*** The display function of the Type-C® port depends on the resolution supported by your processor or graphics card. For more information, please refer to the product manual.</p>
Expansion Slots	<p>Intel® Xeon® 690/670/650 Series Processors*</p> <p>7 x PCIe 5.0 slots (Seven at x16/x16/x16/x16/x16/x8/x16)**</p> <p>Intel® Xeon® 630 Series Processor*</p> <p>7 x PCIe 5.0 slots (Seven at x16/x0/x16/x0/x16/x0/x16)**</p> <p>* Please check PCIe bifurcation table on support site (<a href="https://www.asus.com/support/FAQ/1037507/">https://www.asus.com/support/FAQ/1037507/</a>). Specifications vary by CPU types.</p> <p>** Please refer to the block diagrams in the Appendix for more details.</p> <p>*** CXL (Compute Express Link) is only supported in PCIe16(G5)_1, PCIe16(G5)_3, PCIe16(G5)_5, and PCIe16(G5)_7</p> <p>**** To ensure compatibility of the device installed, please refer to <a href="https://www.asus.com/support/download-center/">https://www.asus.com/support/download-center/</a> for the list of supported peripherals.</p>
Storage	<p><b>Total supports 4 x M.2 slots, 2 x SlimSAS ports, 1 x MCI0 connector, and 4 x SATA 6Gb/s ports*</b></p> <p>Intel® Xeon® 690/670/650 Series Processors**</p> <ul style="list-style-type: none"> <li>- M.2_1 slot (Key M), type 2242/2260/2280/22110 (supports PCIe 5.0 x4 mode)</li> <li>- M.2_2 slot (Key M), type 2242/2260/2280/22110 (supports PCIe 5.0 x4 mode)</li> <li>- M.2_3 slot (Key M), type 2242/2260/2280 (supports PCIe 5.0 x4 mode)</li> <li>- M.2_4 slot (Key M), type 2242/2260/2280 (supports PCIe 5.0 x4 mode)</li> <li>- MCI0 connector (supports PCIe 5.0 x8, and runs at x4/x4)</li> </ul>

(continued on the next page)

## Pro WS W890E-SAGE SE specifications summary

Storage	<p><b>Intel® Xeon® 630 Series Processor**</b></p> <ul style="list-style-type: none"> <li>- M.2_1 slot (Key M), type 2242/2260/2280/22110 (supports PCIe 5.0 x4 mode)</li> <li>- M.2_2 slot (Key M), type 2242/2260/2280/22110 (supports PCIe 5.0 x4 mode)</li> <li>- M.2_3 slot (Key M), type 2242/2260/2280 (supports PCIe 5.0 x4 mode)</li> <li>- M.2_4 slot (Key M), type 2242/2260/2280 (supports PCIe 5.0 x4 mode)</li> </ul> <p><b>Intel® W890 Chipset</b></p> <ul style="list-style-type: none"> <li>- 2 x SlimSAS ports that support PCIe 4.0 x4 mode NVMe device</li> <li>- 4 x SATA 6Gb/s ports</li> </ul> <p>* Specifications vary by CPU types.  <b>** Supports Intel® Virtual RAID on CPU (Intel® VROC) and Intel Volume Management Device (Intel® VMD)</b>  <b>*** Intel® VROC Technology supports PCIe RAID 0/1/5/10, SATA RAID 0/1/5/10. VROC_HW_Key is purchased separately.</b></p>
Ethernet	<p>1 x Intel® dual 10Gb Ethernet  1 x Realtek® 1Gb Ethernet*</p> <p>ASUS LANGuard</p> <p>* This dedicated LAN port is for BMC and IPMI connections only; internet access is not supported.</p>
Wireless & Bluetooth®	<p>M.2 slot only (Key E, CNVi &amp; PCIe)*</p> <p>* Wi-Fi module is sold separately.</p>
USB	<p><b>Rear USB (Total 8 ports)</b></p> <p>2 x USB4® (40Gbps) ports (2 x USB Type-C®)  6 x USB 10Gbps ports (6 x Type-A)</p> <p><b>Front USB (Total 7 ports)</b></p> <p>1 x USB 20Gbps connector (supports USB Type-C®)  1 x USB 5Gbps header supports 2 additional USB 5Gbps ports  2 x USB 2.0 headers support 4 additional USB 2.0 ports</p> <p>* USB Type-C® power delivery output: max. 5V/3A</p>
Audio	<p><b>Realtek® ALC1220P 7.1 Surround Sound High Definition Audio CODEC*</b></p> <ul style="list-style-type: none"> <li>- Impedance sense for front and rear headphone outputs</li> <li>- Internal audio Amplifier to enhance the highest quality sound for headphone and speakers</li> <li>- Supports: Jack-detection, Multi-streaming, Front Panel Jack-retasking</li> <li>- High quality 120 dB SNR stereo playback output and 113 dB SNR recording input (Line-in)</li> <li>- Supports up to 32-Bit/192 kHz playback*</li> </ul> <p><b>Audio Features</b></p> <ul style="list-style-type: none"> <li>- Audio Shielding</li> <li>- Premium audio capacitors</li> <li>- Dedicated audio PCB layers</li> <li>- Unique de-pop circuit</li> </ul> <p>* Due to limitations in HDA bandwidth, 32-Bit/192 kHz is not supported for 7.1 Surround Sound audio.</p>

(continued on the next page)

## Pro WS W890E-SAGE SE specifications summary

<p><b>Back Panel I/O Port</b></p>	<p>2 x USB4® (40Gbps) ports (2 x USB Type-C®)          6 x USB 10Gbps ports (6 x Type-A)          1 x VGA port          2 x Mini DisplayPort IN          2 x Intel® dual 10Gb Ethernet ports          1 x Realtek® 1Gb Ethernet port (Dedicated management LAN for AST2600)          2 x Audio jacks          1 x BIOS FlashBack™ button          1 x Clear CMOS button</p>
<p><b>Internal I/O connectors</b></p>	<p><b>Fan and Cooling Related</b>          1 x 4-pin CPU Fan header          1 x 4-pin CPU OPT Fan header          5 x 4-pin Chassis Fan headers          1 x W_PUMP+ header          2 x 4-pin VRM Fan headers (with one of the VRM fans onboard)          1 x 4-pin M.2 Fan header (with M.2 FAN onboard)</p> <p><b>Power Related</b>          1 x 24-pin Main Power connector          1 x 4-pin to 24-pin Main Power connector          2 x 8-pin +12V CPU Power connectors          2 x 8-pin PCIe to CPU power connectors          2 x 8-pin PCIe Power connectors</p> <p><b>Storage Related</b>          4 x M.2 slots (Key M)          1 x MCI/O connector          4 x SATA 6Gb/s ports          2 x SlimSAS connectors</p> <p><b>USB</b>          1 x USB 20Gbps connector (supports USB Type-C®)          1 x USB 5Gbps header supports 2 additional USB 5Gbps ports          2 x USB 2.0 headers support 4 additional USB 2.0 ports</p> <p><b>Miscellaneous</b>          2 x Addressable RGB Gen 2 headers          1 x Chassis Intrusion header          1 x COM Port header          1 x CPU Over voltage jumper          1 x FlexKey button          1 x Front Panel Audio header (F_AUDIO)          1 x 10-1 pin Front Panel System header          1 x LN2 Mode jumper          1 x M.2 slot (Key E)          7 x Probelts Measurement Points</p>

*(continued on the next page)*

# Pro WS W890E-SAGE SE specifications summary

<p><b>Internal I/O connectors</b></p>	<ul style="list-style-type: none"> <li>1 x ReTry button</li> <li>3 x RSVD header(s)/switch(es)</li> <li>1 x Safe Boot button</li> <li>1 x Slow Mode switch</li> <li>1 x Start button</li> <li>1 x RTC Battery header</li> <li>1 x Thermal Sensor header</li> <li>1 x VROC Key header</li> </ul>
<p><b>Special Features</b></p>	<p><b>ASUS 5X PROTECTION III</b></p> <ul style="list-style-type: none"> <li>- DIGI+ VRM (- Digital power design with DrMOS)</li> <li>- ESD Guards</li> <li>- LANGuard</li> <li>- Overvoltage protection</li> <li>- SafeSlot</li> <li>- Stainless-steel back I/O</li> </ul> <p><b>ASUS Q-Design</b></p> <ul style="list-style-type: none"> <li>- M.2 Q-Latch</li> <li>- M.2 Q-Release</li> <li>- M.2 Q-Slide</li> <li>- PCIe Slot Q-Release Slim (with PCIe SafeSlot)</li> <li>- Q-Code</li> <li>- Q-Connector</li> <li>- Q-LED (CPU [red], DRAM [yellow], VGA [white], Boot Device [yellow green])</li> <li>- Q-Slot</li> </ul> <p><b>ASUS Thermal Solution</b></p> <ul style="list-style-type: none"> <li>- M.2 heatsink backplate</li> <li>- M.2 heatsink</li> <li>- Steel backplate</li> <li>- VRM heatsink design</li> <li>- Fan-based active cooling design for VRM and M.2 heatsinks</li> </ul> <p><b>ASUS EZ DIY</b></p> <ul style="list-style-type: none"> <li>- BIOS FlashBack™ button</li> <li>- BIOS FlashBack™ LED</li> <li>- Clear CMOS button</li> <li>- Dual DIMM clips</li> <li>- ProCool II</li> <li>- Pre-mounted I/O shield</li> <li>- SafeDIMM</li> </ul> <p><b>Aura Sync</b></p> <ul style="list-style-type: none"> <li>- Addressable RGB Gen 2 headers</li> </ul> <p><b>Bespoke Motherboard Design &amp; Business Focused Features</b></p> <ul style="list-style-type: none"> <li>- 24/7 reliability</li> <li>- Overcurrent protection</li> </ul>

*(continued on the next page)*

## Pro WS W890E-SAGE SE specifications summary

<p><b>Software Features</b></p>	<p><b>ASUS Exclusive Software</b></p> <p>Armoury Crate</p> <ul style="list-style-type: none"> <li>- Aura Creator</li> <li>- Aura Sync</li> <li>- Fan Xpert 4</li> </ul> <p>ASUS DriverHub</p> <ul style="list-style-type: none"> <li>- ASUS CPU-Z</li> </ul> <p>Adobe Creative Cloud (Free Trial)**</p> <p>Norton 360 Deluxe (60 Days Free Trial)</p> <p>WinRAR (40 Days Free Trial)</p> <p><b>UEFI BIOS</b></p> <p>ASUS EZ DIY</p> <ul style="list-style-type: none"> <li>- ASUS CrashFree BIOS 3</li> <li>- ASUSTeK. EzFlash Utility</li> </ul> <p>FlexKey</p> <p>* For more software features, please visit the asus support site or refer to <a href="http://www.asus.com/support">www.asus.com/support</a> for additional information.</p> <p>**For detailed information on the supported models and restricted regions for this redemption offer, please refer to <a href="https://www.asus.com/content/asus-offers-adobe-creative-cloud/">https://www.asus.com/content/asus-offers-adobe-creative-cloud/</a>.</p>
<p><b>Remote Management Features</b></p>	<p><b>IT Management software supported</b></p> <ul style="list-style-type: none"> <li>- ASUS Control Center Express(ACCE)</li> </ul> <p><b>BMC Related</b></p> <ul style="list-style-type: none"> <li>1 x BMC switch</li> <li>1 x BMC LAN fixed IP switch</li> <li>1 x Message LED header</li> <li>1 x microSD card socket</li> <li>2 x LAN LED headers</li> <li>1 x Location LED header</li> <li>1 x Location button header</li> <li>1 x PSU_SMB header</li> <li>1 x SMART_PSU switch</li> <li>1 x VGA switch</li> <li>1 x VPP_I2C header</li> </ul> <p><b>BMC LED Design</b></p> <ul style="list-style-type: none"> <li>- 1 x BMC LED</li> <li>- 1 x Message LED</li> <li>- 1 x Location LED</li> <li>- 1 x Location button LED</li> </ul>
<p><b>BIOS</b></p>	<p>512 Mb Flash ROM, UEFI AMI BIOS (text-based)</p>
<p><b>BIOS CAP Filename</b></p>	<p><b>Pro WS W890E-SAGE SE:</b> A5709.CAP</p>
<p><b>Manageability</b></p>	<p>WOL by PME, PXE</p>

(continued on the next page)

# Pro WS W890E-SAGE SE specifications summary

Operating System	Windows 11
Form Factor	EEB Form Factor 12 inch x 13 inch (30.5 cm x 33 cm)

---

**NOTE:** Specifications are subject to change without notice. Please refer to the ASUS website for the latest specifications.

---

## Package contents

Check your motherboard package for the following items.

Motherboard	1 x Pro WS W890E-SAGE SE motherboard
Cables	2 x SATA 6Gb/s cables
	1 x Thermistor cable pack
	2 x mini DisplayPort cables
	1 x 4-pin to 24-pin adapter cable for ATX power connector
Additional Cooling Kit	1 x AngleBoost Fan Kit
	2 x Thermal pads for M.2 22110
Miscellaneous	1 x Q-connector
	1 x M.2 Q-Latch package
	1 x AMI license sticker
	1 x M.2 backplate rubber package
	1 x Screw package for M.2 Key E
	1 x E2A CPU carrier (for Intel® Xeon® 690 Series Processors)
	1 x E2B CPU carrier (for Intel® Xeon® 670/650/630 Series Processors)
Documentation	1 x ACC Express activation key card
	1 x Quick start guide

---

### NOTE:

- If any of the above items is damaged or missing, contact your retailer.
  - Items not listed in the Package contents list above are purchased separately and do not come bundled with your motherboard package.
-

# Connectors with shared bandwidth

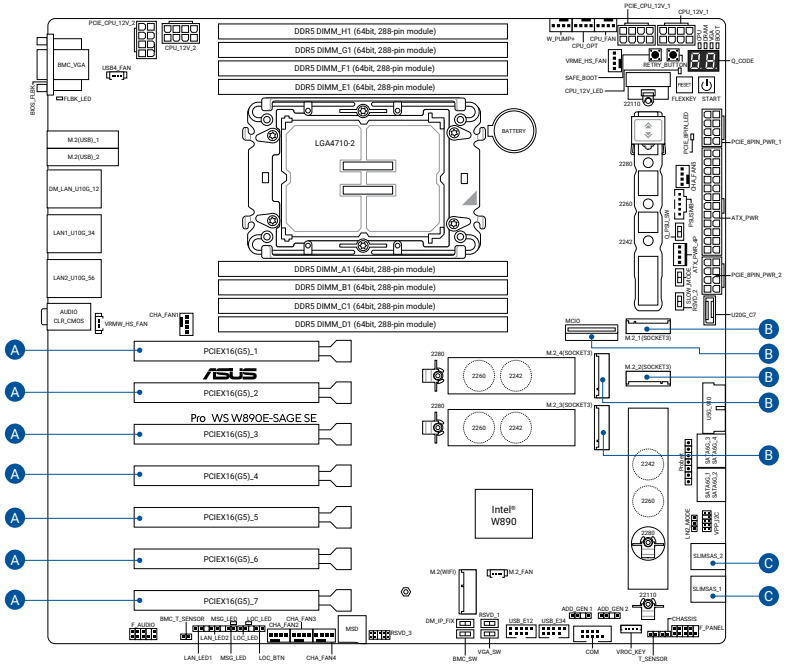

Configuration	1 (Default)	
A	PCIEX16(G5)_1	x16
	PCIEX16(G5)_2	x16
	PCIEX16(G5)_3	x16
	PCIEX16(G5)_4	x16
	PCIEX16(G5)_5	x16
	PCIEX16(G5)_6	x8
	PCIEX16(G5)_7	x16
B	M.2_1(SOCKET3)	x4
	M.2_2(SOCKET3)	x4
	M.2_3(SOCKET3)	x4
	M.2_4(SOCKET3)	x4
	MCIO	x4/x4
C	SlimSAS_1	x4
	SlimSAS_2	x4

# Product Introduction

## 1.1 Before you proceed

Take note of the following precautions before you install motherboard components or change any motherboard settings.

---

**CAUTION!**

- Unplug the power cord from the wall socket before touching any component.
- Before handling components, use a grounded wrist strap or touch a safely grounded object or a metal object, such as the power supply case, to avoid damaging them due to static electricity.
- Hold components by the edges to avoid touching the ICs on them.
- Whenever you uninstall any component, place it on a grounded antistatic pad or in the bag that came with the component.
- Before you install or remove any component, ensure that the power supply is switched off or the power cord is detached from the power supply. Failure to do so may cause severe damage to the motherboard, peripherals, or components.

---

**NOTE:** The pin definitions in this chapter are for reference only. The pin names depend on the location of the header/jumper/connector.

---

## 1.2 Motherboard layout

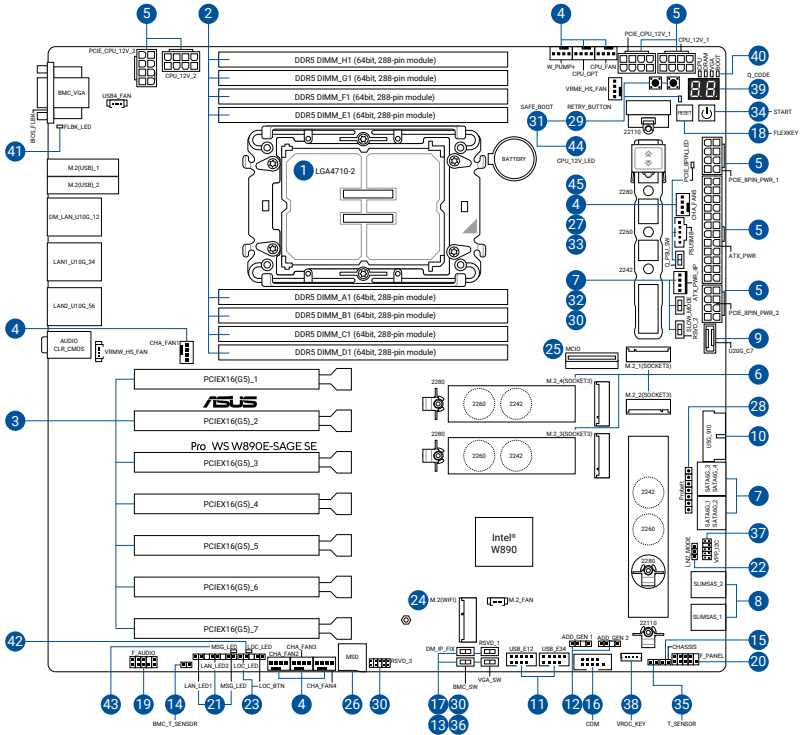

### Layout contents

1. CPU socket
2. DIMM slots
3. Expansion slots
4. Fan and Pump headers
5. Power connectors
6. M.2 slot
7. SATA 6Gb/s port
8. SlimSAS connector
9. USB 20Gbps Type-C® Front Panel connector
10. USB 5Gbps header
11. USB 2.0 header
12. Addressable Gen 2 header
13. BMC switch
14. BMC Thermal Sensor header

(continued on the next page)

## Layout contents

15. Chassis Intrusion header
16. COM Port connector
17. Fixed Dedicated BMC LAN IP switch
18. FlexKey button (Reset)
19. Front Panel Audio header
20. Front Panel System header
21. LED headers
22. LN2 Mode jumper
23. Location button and LED headers
24. M.2 slot (Key E)
25. MCIO connector
26. microSD Card slot
27. Power Supply SMBus connector
28. Probelst Measurement Points
29. ReTry button
30. RSVD switch and header
31. Safe Boot button
32. Slow Mode switch
33. SMART PSU switch
34. Start button
35. Thermal Sensor header
36. VGA switch
37. VPP\_I2C header
38. VROC header
39. Q-Code LED
40. Q-LEDs
41. BIOS FlashBack™ LED
42. Location LED
43. Message LED
44. 8-pin CPU Power Plug LED
45. 8-pin PCIE Power Plug LED

## 1. CPU socket

The motherboard comes with a LGA4710-2 socket designed for Xeon® 600 Processors.

LGA4710-2

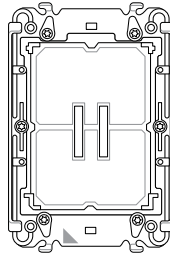

---

### CAUTION!

- Keep the cap after installing the motherboard. ASUS will process Return Merchandise Authorization (RMA) requests only if the motherboard comes with the cap on the CPU socket.
  - Ensure the CPU is installed with the triangle on the CPU aligned to the same corner as the triangle on the socket.
  - The product warranty does not cover damage to the socket contacts resulting from incorrect CPU installation/removal, or misplacement/loss/incorrect removal of the PnP cap.
- 

## 2. DIMM slots

The motherboard comes with Dual Inline Memory Modules (DIMM) slots designed for DDR5 (Double Data Rate 5) memory modules.

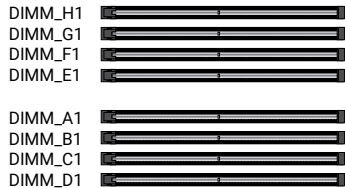

---

**CAUTION!** A DDR5 memory module is notched differently from a DDR, DDR2, DDR3, or DDR4 module. DO NOT install a DDR, DDR2, DDR3, or DDR4 memory module to the DDR5 slot.

---

## Recommended memory configurations

Memory configurations	DIMM							
	A1	B1	C1	D1	E1	F1	G1	H1
1 DIMM	✓							
2 DIMMs	✓				✓			
4 DIMMs	✓	✓			✓	✓		
6 DIMMs	✓	✓	✓		✓	✓	✓	
8 DIMMs	✓	✓	✓	✓	✓	✓	✓	✓

## Memory configurations

You may install ECC Registered DIMMs (RDIMM), 3DS-RDIMMs, and Multiplexed Combined Rank DIMMs (MRDIMM) into the DIMM sockets.

---

**NOTE:**

- The default memory operation frequency is dependent on its Serial Presence Detect (SPD), which is the standard way of accessing information from a memory module. Under the default state, some memory modules for overclocking may operate at a lower frequency than the vendor-marked value.
  - For system stability, use a more efficient memory cooling system to support a full memory load or overclocking condition.
  - Always install the DIMMS with the same CAS Latency. For an optimum compatibility, we recommend that you install memory modules of the same version or data code (D/C) from the same vendor. Check with the vendor to get the correct memory modules.
  - Visit the ASUS website for the latest QVL.
-

### 3. Expansion slots

**CAUTION!** Unplug the power cord before adding or removing expansion cards. Failure to do so may cause you physical injury and damage motherboard components.

**NOTE:** To install a PCIe expansion card, please refer to the **Motherboard Installation Guide** on the ASUS support site.

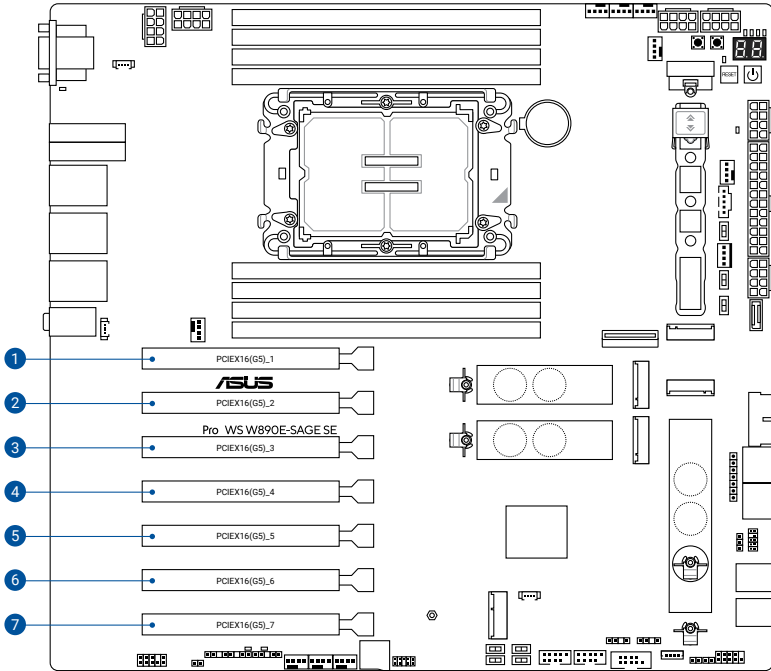

Please refer to the following table for PCIe bifurcation configuration.

## PCIe bifurcation settings in PCIe x16 slots (from CPU)

Slot Description		Quantity of identifiable Intel M.2 SSD (pcs)	
		Intel® Xeon® 690/670/650 Series Processors	Intel® Xeon® 630 Series Processor
1	PCIEX16(G5)_1	4 (x4+x4+x4+x4)	4 (x4+x4+x4+x4)
2	PCIEX16(G5)_2	4 (x4+x4+x4+x4)	-
3	PCIEX16(G5)_3	4 (x4+x4+x4+x4)	4 (x4+x4+x4+x4)
4	PCIEX16(G5)_4	4 (x4+x4+x4+x4)	-
5	PCIEX16(G5)_5	4 (x4+x4+x4+x4)	4 (x4+x4+x4+x4)
6	PCIEX16(G5)_6	2 (x4+x4)	-
7	PCIEX16(G5)_7	4 (x4+x4+x4+x4)	4 (x4+x4+x4+x4)

---

### NOTE:

- Hyper M.2 X16 series card sold separately.
  - Additional PCIe bifurcation and M.2 settings for RAID function are also supported when a Hyper M.2 x16 series card is installed.
  - For more details on the PCIe bifurcation, you may visit the support site at <https://www.asus.com/support/FAQ/1037507/>.
  - Adjust the PCIe bifurcation under BIOS settings.
  - Creating RAID with the Hyper M.2 X16 series card is limited to a maximum of 10 SSDs.
-

## Using the PCIe Slot Q-Release Slim

The PCIe Slot Q-Release Slim feature allowing you to easily remove an expansion card installed to this PCIe slot, even when an expansion card may be blocking the PCIe push-latch.

To release an expansion card on a PCIe Slot Q-Release Slim:

1. Make sure the expansion card is aligned to the PCIe slot and perpendicular to the motherboard before removing the expansion card.
2. Hold firmly onto the end of the expansion card closest to the motherboard rear IO ports, then slightly pull the expansion card away from the motherboard at an angle to release the expansion card.
3. Once the expansion card is completely released from the PCIe Slot Q-Release Slim, you may remove the expansion card.

---

**NOTE:** The illustration below is for reference only. The motherboard and PCIe Slot Q-Release Slim may differ between models, but the steps for using the PCIe Slot Q-Release Slim remain the same.

---

**CAUTION!** ONLY remove the expansion card from the end closest to the motherboard rear IO ports. Removing the expansion card by holding onto any other part of the expansion card with excessive force may cause damages to the expansion card and/or motherboard.

---

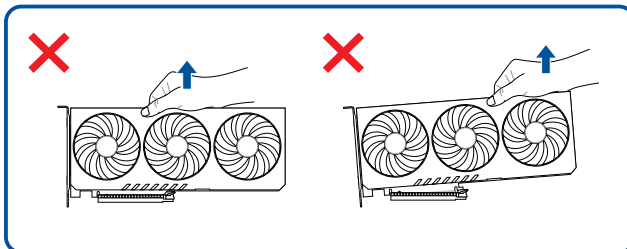
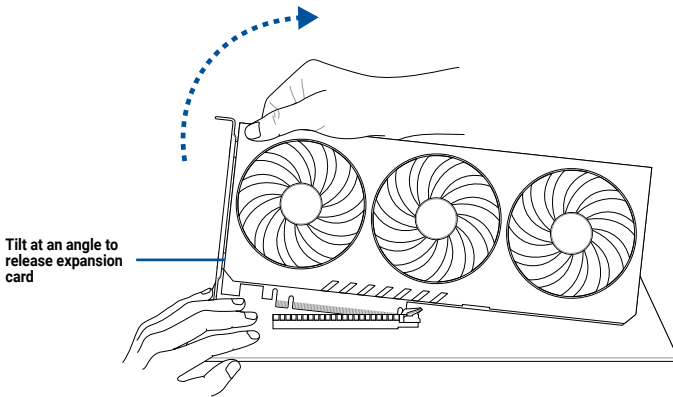

## 4. Fan and Pump headers

The Fan and Pump headers allow you to connect fans or pumps to cool the system.

CPU_FAN	CHA_FAN2	
CPU_OPT	CHA_FAN3	
W_PUMP+	CHA_FAN4	
CHA_FAN1	CHA_FAN5	

---

### CAUTION!

- DO NOT forget to connect the fan cables to the fan headers. Insufficient air flow inside the system may damage the motherboard components. These are not jumpers! Do not place jumper caps on the fan headers!
  - Ensure the cable is fully inserted into the header.
- 

**IMPORTANT!** For water cooling kits, connect the pump connector to the **W\_PUMP+** header.

---

### NOTE:

- When connecting a single CPU fan, you may connect it to either the **CPU\_FAN** or **CPU\_OPT** header.
  - When connecting two CPU fans, ensure to connect the fans to the **CPU\_FAN** and the **CPU\_OPT** header, and make sure both fans are the same brand and model.
  - **W\_PUMP+** function support depends on water cooling device.
- 

Header	Max. Current	Max. Power	Default Speed	Shared Control
CPU_FAN	3A	36W	Q-Fan Controlled	A
CPU_OPT	3A	36W	Q-Fan Controlled	A
CHA_FAN1	3A	36W	Q-Fan Controlled	-
CHA_FAN2	3A	36W	Q-Fan Controlled	-
CHA_FAN3	3A	36W	Q-Fan Controlled	-
CHA_FAN4	3A	36W	Q-Fan Controlled	-
CHA_FAN5	3A	36W	Q-Fan Controlled	-
W_PUMP+	3A	36W	Full Speed	-
M.2_FAN	3A	36W	Q-Fan Controlled	-

## 5. Power connectors

These Power connectors allow you to connect your motherboard to a power supply. The power supply plugs are designed to fit in only one orientation, find the proper orientation and push down firmly until the power supply plugs are fully inserted.

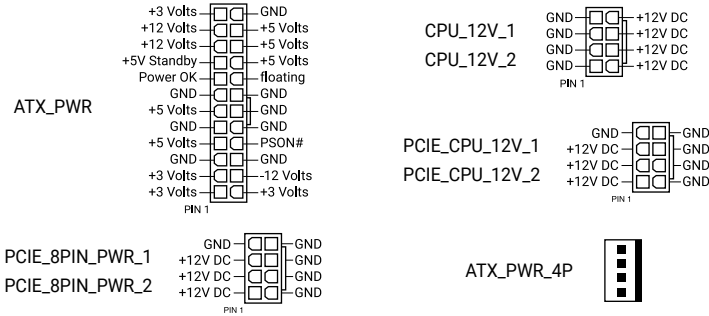

---

**CAUTION!** Ensure to connect the 8-pin power plugs.

---

**IMPORTANT!** The recommended installation for a single and for double PSUs will differ, please refer to the **ATX power connection** section for more information.

---

**NOTE:**

- We recommend that you use a PSU with a higher power output when configuring a system with more power-consuming devices. The system may become unstable or may not boot up if the power is inadequate.
  - If you want to use two or more high-end PCI Express x16 cards, we recommend using a PSU with 900W~1200W power or above to ensure the system stability.
  - PSU input: AC 100~240V, 6A/3A, 50/60Hz.
-

## 6. M.2 slot

The M.2 slot allows you to install M.2 devices such as M.2 SSD modules.

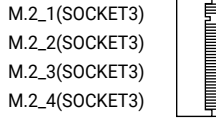

### NOTE:

- **Intel® Xeon® 690/670/650/630 Series Processors:**
  - M.2\_1 slot (Key M), type 2242/2260/2280/22110 (supports PCIe 5.0 x4 mode)
  - M.2\_2 slot (Key M), type 2242/2260/2280/22110 (supports PCIe 5.0 x4 mode)
  - M.2\_3 slot (Key M), type 2242/2260/2280 (supports PCIe 5.0 x4 mode)
  - M.2\_4 slot (Key M), type 2242/2260/2280 (supports PCIe 5.0 x4 mode)
- Supports Intel® Virtual RAID on CPU (Intel® VROC) and Intel Volume Management Device (Intel®VMD)

## 7. SATA 6Gb/s port

The SATA 6Gb/s port allows you to connect SATA devices such as optical disc drives and hard disk drives via a SATA cable.

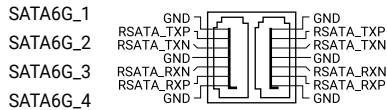

### NOTE:

- If you installed SATA storage devices to the SATA6G\_1-4 ports, you can create RAID configurations with the Intel® Rapid Storage Technology through the onboard Intel® W890 chipset.
- To install a SATA device, please refer to the **Motherboard Installation Guide** on the ASUS support site.
- Before creating a RAID set, refer to the **RAID Configuration Guide**. You can download the **RAID Configuration Guide** from the ASUS website.

## 8. SlimSAS connector

The SlimSAS port allows you to connect NVMe storage devices, and can support up to 4 SATA devices using an adapter cable.

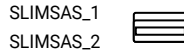



---

**IMPORTANT!** SLIMSAS\_1 and SLIMSAS\_2 supports PCIE 4.0 x4 mode NVMe devices.

---

## 9. USB 20Gbps Type-C® Front Panel connector

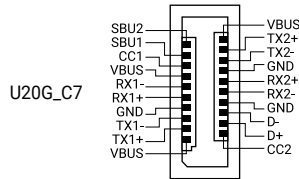
The USB 20Gbps Type-C® connector allows you to connect a USB 20Gbps Type-C® module for additional USB 20Gbps ports on the front panel. The USB 20Gbps Type-C® connector provides data transfer speeds of up to 20 Gb/s.



## 10. USB 5Gbps header

The USB 5Gbps header allows you to connect a USB 5Gbps module for additional USB 5Gbps ports. The USB 5Gbps header provides data transfer speeds of up to 5 Gb/s.

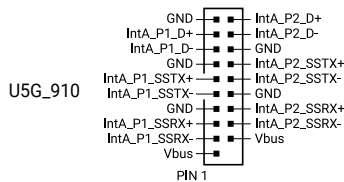

## 11. USB 2.0 header

The USB 2.0 header allows you to connect a USB module for additional USB 2.0 ports. The USB 2.0 header provides data transfer speeds of up to 480 Mb/s.

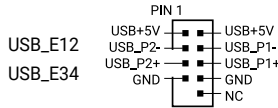

---

**CAUTION!** DO NOT connect a 1394 cable to the USB connectors. Doing so will damage the motherboard!

---

## 12. Addressable Gen2 header

The Addressable Gen2 header allows you to connect individually addressable RGB (ARGB) WS2812B LED strips or WS2812B based LED strips.

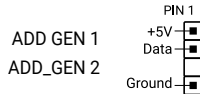

---

**CAUTION!** Before you install or remove any component, ensure that the power supply is switched off or the power cord is detached from the power supply. Failure to do so may cause severe damage to the motherboard, peripherals, or components.

---

### NOTE:

- The Addressable Gen2 header supports addressable RGB LED strips (5V/Data/Ground), with a maximum power rating of 3A (5V). Additionally, the addressable header on this board can support up to 120 LEDs per header in Gen1 mode, or a combined maximum of 500 LEDs in Gen2 mode.
  - Actual lighting and color will vary with LED strip.
  - If your LED strip does not light up, check if the addressable RGB LED strip is connected in the correct orientation, and the 5V connector is aligned with the 5V header on the motherboard.
  - The addressable RGB LED strip will only light up when the system is powered on.
-

### 13. BMC switch

The BMC switch allows you to enable or disable the BMC.

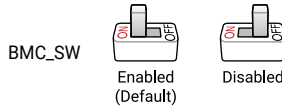

---

**CAUTION!** Ensure the ATX power supply is switched off or the power cord is detached from the power supply when enabling or disabling BMC using this switch.

---

### 14. BMC Thermal Sensor header

The BMC Thermal Sensor header allows you to connect a sensor to monitor the temperature of the devices and the critical components inside the motherboard through BMC. Connecting the T sensor cables and setting **BMC\_SW** to enabled will allow you to view the sensor readings in both the BIOS (**Tool > IPMI Hardware Monitor**) and on the web UI.



### 15. Chassis Intrusion header

The Chassis Intrusion header allows you to connect a intrusion sensor or microswitch for the chassis intrusion detection feature. When you remove any chassis component, the sensor or microswitch triggers and sends a high level signal and records a chassis intrusion event.



### 16. COM Port connector

The COM (Serial) Port connector allows you to connect a COM port module. Connect the COM port module cable to this connector, then install the module to a slot opening on the system chassis.

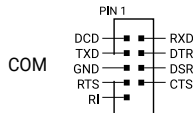

## 17. Fixed Dedicated BMC LAN IP switch

The Fixed Dedicated BMC LAN IP switch allows you to set a fixed IP (10.10.10.10) when set to enabled.

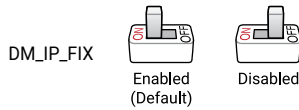

## 18. FlexKey button (Reset)

Press the FlexKey button to reboot the system. You may also configure the button and assign a quick access feature such as activating Safe Boot or turning Aura lighting on or off to the button.



## 19. Front Panel Audio header

The Front Panel Audio header is for a chassis-mounted front panel audio I/O module that supports HD Audio. Connect one end of the front panel audio I/O module cable to this header.

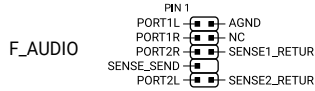

## 20. Front Panel System header

The Front Panel System header supports several chassis-mounted functions.

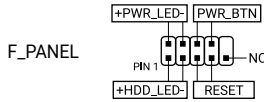

- **System Power LED header (+PWR\_LED-)**

The 2-pin header allows you to connect the System Power LED. The System Power LED lights up when the system is connected to a power source, or when you turn on the system power, and blinks when the system is in sleep mode.

- **Storage Device Activity LED header (+HDD\_LED-)**

The 2-pin header allows you to connect the Storage Device Activity LED. The Storage Device Activity LED lights up or blinks when data is read from or written to the storage device or storage device add-on card.

- **Power Button/Soft-off Button header (PWR\_BTN)**

The 3-1 pin header allows you to connect the system power button. Press the power button to power up the system, or put the system into sleep or soft-off mode (depending on the operating system settings).

- **Reset button header (RESET)**

The 2-pin header allows you to connect the chassis-mounted reset button. Press the reset button to reboot the system.

## 21. LED headers

The LED headers allow you to connect external LEDs to the Message LED, LAN1 LED, LAN2 LED.

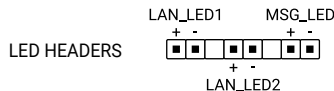

- **LAN activity LED (2-pin LAN\_LED1, LAN\_LED2)**

These connectors are for the Gigabit LAN activity LEDs on the front panel.

- **Message LED (2-pin MSG\_LED)**

This 2-pin connector is for the message LED cable that connects to the front message LED. The message LED is controlled by the BMC to indicate an abnormal event occurrence.

## 22. LN2 Mode jumper

Set to pins 2-3 to optimize the motherboard to remedy the cold-boot bug during POST and help the system boot successfully.

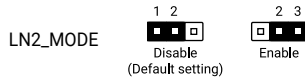

## 23. Location button and LED headers

The Location button and LED headers allow you to connect a locator button and locator LED on the front panel. This button queries the state of the system locator, and the LEDs will light up when the Locator button is pressed.

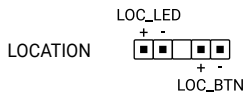

## 24. M.2 slot (Key E)

The M.2 Wi-Fi slot allows you to install an M.2 Wi-Fi module (E-key, type 2230; CNVi and PCIe interface).

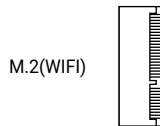

## 25. MCIO connector

The MCIO connector allows you to connect a PCIe signal to a MCIO port and supports PCIe 5.0 x4/x4 mode.

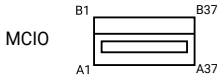

Pin definition			
Pin	Signal	Signal	Pin
A1	GND	GND	B1
A2	PERp0	PETp0	B2
A3	PERn0	PETn0	B3
A4	GND	GND	B4
A5	PERp1	PETp1	B5
A6	PERn1	PETn1	B6
A7	GND	GND	B7
A8	Activity	SMSCL	B8
A9	Wake	SMSDA	B9
A10	GND	GND	B10
A11	RCLK_p	PERST	B11
A12	RCLK_n	PRSENT	B12
A13	GND	GND	B13
A14	PERp2	PETp2	B14
A15	PERn2	PETn2	B15
A16	GND	GND	B16
A17	PERp3	PETp3	B17
A18	PERn3	PETn3	B18
A19	GND	GND	B19
A20	PERp4	PETp4	B20
A21	PERn4	PETn4	B21
A22	GND	GND	B22
A23	PERp5	PETp5	B23
A24	PERn5	PETn5	B24
A25	GND	GND	B25
A26	Activity	SMSCL	B26
A27	Wake	SMSDA	B27
A28	GND	GND	B28
A29	RCLK_p	PERST	B29
A30	RCLK_n	PRSENT	B30
A31	GND	GND	B31
A32	PERp6	PETp6	B32
A33	PERn6	PETn6	B33
A34	GND	GND	B34
A35	PERp7	PETp7	B35
A36	PERn7	PETn7	B36
A37	GND	GND	B37

**NOTE:** Please ensure to check that the pin definition of the MCIO cable matches the pin definition above before connecting the MCIO cable.

## 26. microSD Card slot

The microSD Card slot allows you to install a microSD memory card v2.00 (SDHC) / v3.00 (SDXC) to log BMC events.



---

### CAUTION!

- Disconnect all power (including redundant PSUs) from the existing system before you add or remove a memory card, then reboot the system to access the memory card.
- Some memory cards may not be compatible with your motherboard. Ensure that you use only compatible memory cards to prevent loss of data, damage to your device, or memory card, or both.

---

**NOTE:** The microSD Slot is only supported with BMC Function and not supported for normal use under the OS.

---

## 27. Power Supply SMBus connector

The Power Supply SMBus connector allows you to connect the SMBus (System Management Bus) to the PSU (power supply unit) to read the PSU information. Devices communicate with an SMBus host and/or other SMBus devices using the SMBus interface.

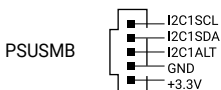

---

**NOTE:** Power supply is required to meet PMBus specification and customized BMC FW may be needed. Please contact ASUS if your need further support

---

## 28. Probelst Measurement Points

The ROG Probelst allows you to detect your system's current voltage and OC settings using a multimeter. You can also measure the Probelst points during overclocking.

●	VCORE
●	VFAON
●	FIVRA
●	HV1
●	HV0
●	VNN
●	EHV

Probelst

### Using Probelst

Connect one of the probe onto the **GND** Probelst point, then connect the other probe onto another Probelst point to measure the corresponding voltage information.

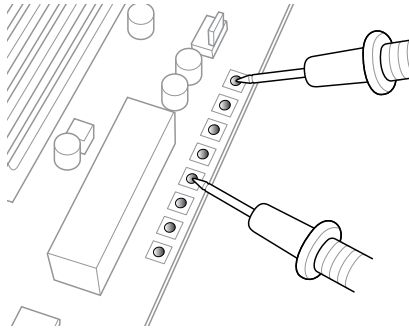

---

**NOTE:** The illustration above is for reference only, the actual motherboard layout and measure points may differ by model.

---

## 29. ReTry button

The ReTry button is specially designed for overclockers and is most useful during the booting process where the Reset button is rendered useless. Press this button to force the system to reboot while retaining the same settings to be retried in quick succession to achieve a successful POST.

RETRY\_BUTTON



### 30. RSVD switch and header

The RSVD switch and header is reserved for ASUS-authorized technicians only.

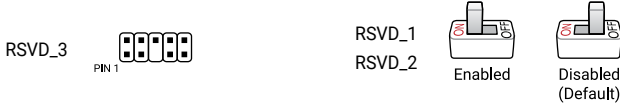

---

**CAUTION!** Please ensure the RSVD switch is set to **Disabled**. Setting this switch to **Enabled** may result in damages to your system.

---

### 31. Safe Boot button

The Safe Boot button temporarily applies safe settings to the BIOS while retaining the overclocked settings, allowing you to modify the settings causing a boot failure. Press this button at anytime to force the system to reboot into the BIOS safe mode.

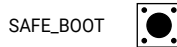

### 32. Slow Mode switch

The system may crash due to the CPU being unstable when using extreme overclocking settings. Enable the Slow Mode switch during LN2 benching to decrease the processor frequency and stabilize the system, allowing you to keep track of the overclocking data.

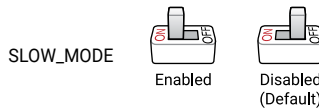

### 33. SMART PSU switch

This switch allows you to select PSU PMBus version.

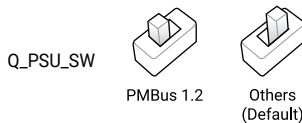

### 34. Start button

Press the Start button to power up the system, or put the system into sleep or soft-off mode (depending on the operating system settings).

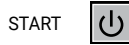

### 35. Thermal Sensor header

The Thermal Sensor header allows you to connect a sensor to monitor the temperature of the devices and the critical components inside the motherboard. Connect the thermal sensor and place it on the device or the motherboard's component to detect its temperature.



### 36. VGA switch

The VGA switch allows you to enable or disable the onboard VGA controller.

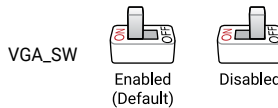

---

**CAUTION!** Ensure the ATX power supply is switched off or the power cord is detached from the power supply when enabling or disabling the VGA controller settings using this switch.

---

**NOTE:**

- If a VGA Card is installed into a PCI Express x16 Slot, the onboard VGA function will still be enabled.
  - BMC Remote Management Function will still be available when VGA controller settings is set to disabled, but the display will be disabled on the client device.
- 

### 37. VPP\_I2C header

The VPP\_I2C header is used for the storage backplane with sensor readings. This header can also be be connected to customized backplanes in conjunction with custom BIOS and BMC firmwares to display the control LEDs or allow the BMC read the backplane functions.

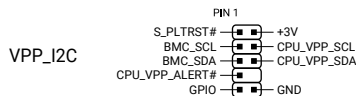

### 38. VROC Key header

The VROC (Virtual RAID on CPU) Key header allows you to connect a VROC hardware key to enable additional CPU RAID functions with Intel® VROC.

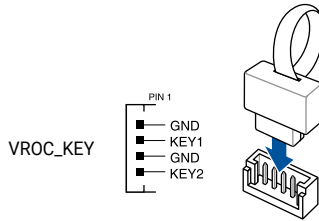

**NOTE:** The VROC hardware key is purchased separately.

VROC specifications may vary depending on the VROC hardware key purchased, please refer to the table below for the different specifications:

Features		Pass Thru (included with PCH)	Standard SKU	Premium SKU	Boot SKU
Intel VMD	Hot-plug / Fault Isolation	V	V	V	V
	LED Management	V	V	V	V
	3 <sup>rd</sup> Party SSD Support (non-RAID)	V	V	V	V
NVMe RAID	3 <sup>rd</sup> Party SSD Support (RAID)	-	V	V	V
	Bootable RAID	-	V	V	RAID1 only
	RAID 0/1/10	-	V	V	RAID1 only
	RAID 5	-	-	V	-
SATA RAID	SATA RAID on PCH • Bootable RAID • RAID 0/1/5/10	V	V	V	V

Also take note of the following regarding the VMD Domain in the VROC software:

- Bootable RAID can only be created in the same VMD Domain.
- Data RAID can be created across different VMD Domains.
- Each PCIe slot coming from the CPU is categorized as its own individual VMD domain. If you wish to create a bootable RAID using the PCIe slots from CPU, you can only do so on individual VMD Domains, for more information please refer to the table below:

PCIe slot	Individual VMD Domain	Bootable RAID	Data RAID
PCIEX16(G5)_1	1	V	Can be created across different VMD domains
PCIEX16(G5)_2	1	V	
PCIEX16(G5)_3	1	V	
PCIEX16(G5)_4	1	V	
PCIEX16(G5)_5	1	V	
PCIEX16(G5)_7	1	V	
PCIEX16(G5)_6	1	V	
MCIO			
M.2_1	1	V	
M.2_2			
M.2_3			
M.2_4			

### 39. Q-Code LED

The Q-Code LED design provides you with a 2-digit error code that displays the system status.



---

**NOTE:**

- The Q-Code LEDs provide the most probable cause of an error code as a starting point for troubleshooting. The actual cause may vary from case to case.
  - Please refer to the Q-Code table in the **Appendix** section for more details.
-

#### 40. Q-LEDs

The Q-LEDs check key components (CPU, DRAM, VGA, and booting devices) during the motherboard booting process. If an error is found, the critical component's LED stays lit up until the problem is solved.

CPU (RED)	■
DRAM (YELLOW)	■
VGA (WHITE)	□
BOOT (YELLOW GREEN)	■

---

**NOTE:** The Q-LEDs provide the most probable cause of an error code as a starting point for troubleshooting. The actual cause may vary from case to case.

---

#### 41. BIOS FlashBack™ LED

The BIOS FlashBack™ LED lights up or blinks to indicate the status of the BIOS FlashBack™.

FLBK\_LED □

---

**NOTE:** Refer to the **BIOS FlashBack™** section for more information on using the BIOS FlashBack™ feature.

---

#### 42. Location LED

The Location LED lights up when the Location button on the server is pressed or when triggered by a system management software. The Location LED helps visually locate and quickly identify the server in error on a server rack.

LOC\_LED □

#### 43. Message LED

The message LED is controlled by the BMC to indicate an abnormal event occurrence.

MSG\_LED □

#### 44. 8-pin CPU Power Plug LED

The 8-pin CPU Power Plug LED lights up to indicate that the 8-pin CPU power plug is not connected.

CPU\_12V\_LED □

#### 45. 8-pin PCIe Power Plug LED

The 8-pin PCIe Power Plug LED lights up to indicate if the 8-pin power plug **PCIE\_8PIN\_PWR** is not connected.

PCIE\_8PIN\_LED

## 1.3 Motherboard rear and audio connections

### 1.3.1 Rear I/O connection

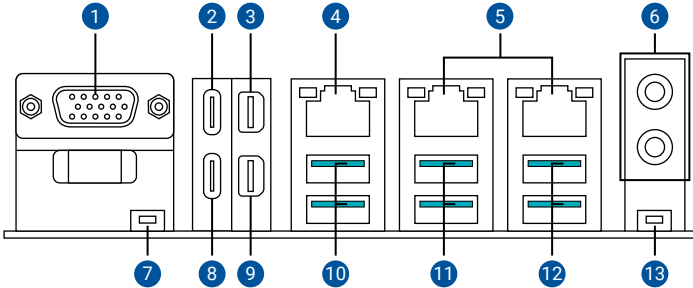

Rear panel connectors	
1.	VGA port from AST2600
2.	USB4® (40Gbps) Type-C® port 2 with DP support
3.	Mini DisplayPort IN port1
4.	Realtek® 1Gb Ethernet port
5.	Intel® 10Gb Ethernet ports*
6.	Audio jacks
7.	BIOS FlashBack™ button
8.	USB4® (40Gbps) Type-C® port 1 with DP support
9.	Mini DisplayPort IN port 2
10.	USB 10Gbps (Teal) Type-A ports 1 and 2
11.	USB 10Gbps (Teal) Type-A ports 3 and 4
12.	USB 10Gbps (Teal) Type-A ports 5 and 6
13.	Clear CMOS button (CLR_CMOS). Press this button to clear the BIOS setup information only when the systems hangs due to overclocking.

#### NOTE:

- We strongly recommend that you connect your devices to ports with matching data transfer rate. For example connecting your USB 5Gbps devices to USB 5Gbps ports for faster and better performance for your devices.
- Refer to the tables under LAN port LEDs, and Audio I/O connections sections for more information on the LAN port LEDs and Audio I/O connections.
- If the system cannot recognize the USB4® device in Device Management, please visit the ASUS FAQ for the solution and download the driver.
- \* Please use a shielded Ethernet cable for minimum radiated emission.
- \* Connect to this LAN port for the ASUS DriverHub installation prompt.

## 1.3.2 LAN port LEDs

### Realtek® 1Gb Ethernet port LED indications

Activity Link LED		Speed LED	
Status	Description	Status	Description
OFF	No link	OFF	10 Mbps connection
ORANGE	Linked	ORANGE	100 Mbps connection
BLINKING	Data activity	GREEN	1 Gbps connection

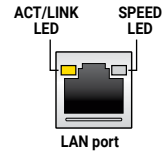

### Intel® 10Gb Ethernet port LED indications

Activity Link LED		Speed LED	
Status	Description	Status	Description
OFF	No link	OFF	100 Mbps
GREEN	Linked	GREEN	10 Gbps
BLINKING	Data activity	ORANGE	5 Gbps/ 2.5 Gbps/ 1Gbps connection

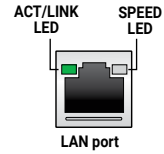

## 1.3.3 Audio I/O connections

### Audio 2, 4, 5.1 or 7.1-channel configuration

Port	2-channel	4-channel	5.1-channel	7.1-channel
<b>Rear panel</b>				
LINE OUT	Front Speaker Out	Front Speaker Out	Front Speaker Out	Front Speaker Out
MIC IN	-	-	Center/ Subwoofer	Center/ Subwoofer
<b>Front panel</b>				
HEADPHONE (Lime)	-	-	-	Side Speaker Out
MIC IN (Pink)	-	Rear Speaker Out	Rear Speaker Out	Rear Speaker Out

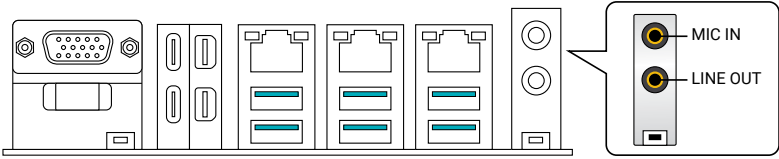

**Connect to Headphone and Mic**

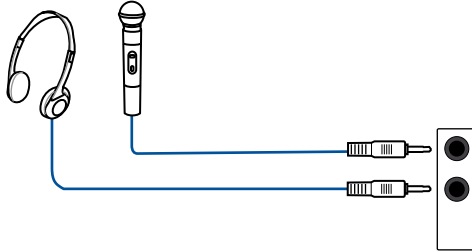

**Connect to 2-channel Speakers**

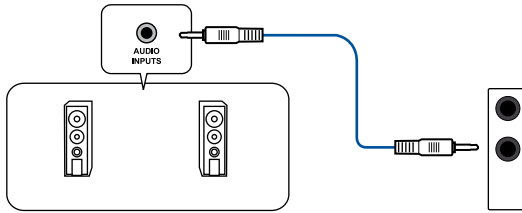

## Connect to 4-channel Speakers

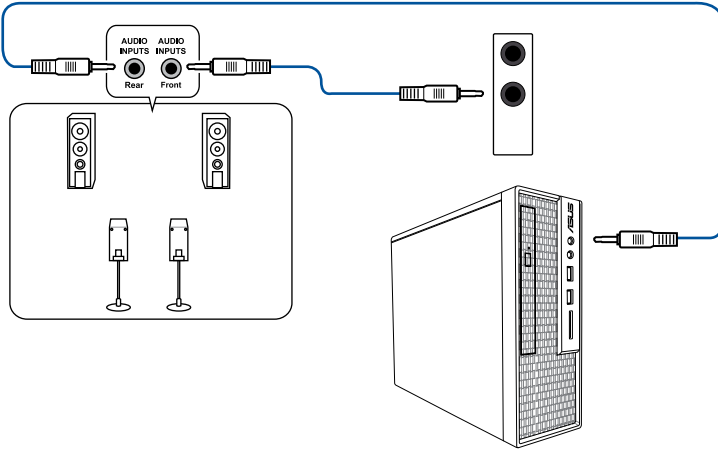

## Connect to 5.1-channel Speakers

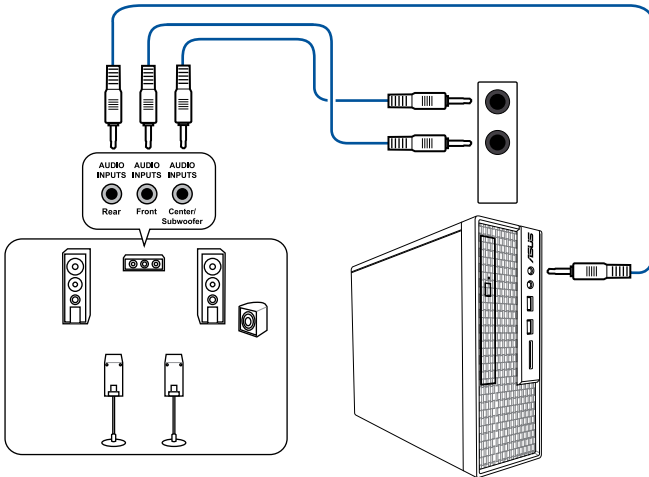

Connect to 7.1-channel Speakers

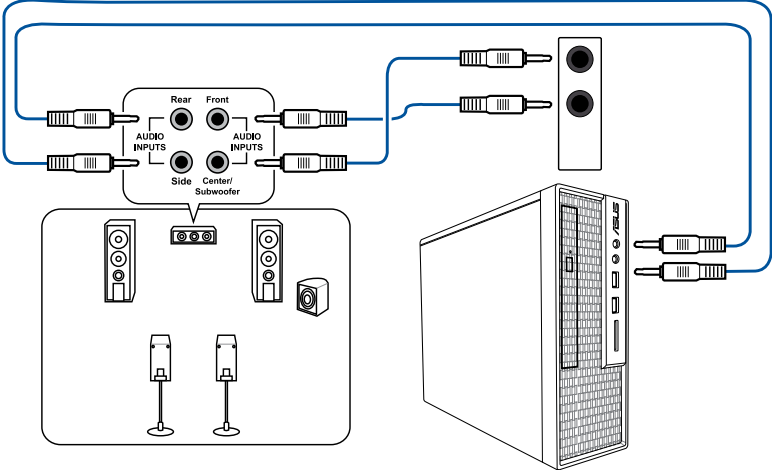

# Basic Setup

---

**NOTE:** The installation diagrams in this section are for reference only. The motherboard layout may vary with models, but the installation steps are the same for all models.

---

## 2.1 CPU installation

---

### CAUTION!

- Ensure that you install the Xeon® 600 processors designed for LGA4710-2 socket.
  - The CPU fits in only one correct orientation. DO NOT force the CPU into the socket to prevent bending the connectors on the socket and damaging the CPU.
  - Ensure that all power cables are unplugged before installing the CPU.
  - Upon purchase of the motherboard, ensure that the PnP cap is on the socket and the socket contacts are not bent. Contact your retailer immediately if the PnP cap is missing, or if you see any damage to the PnP cap/socket contacts/motherboard components. ASUS will shoulder the cost of repair only if the damage is shipment/transit-related.
- 

**IMPORTANT!** Install a heatsink or AIO cooler after installing the CPU. Please refer to the **Motherboard Installation Guide** on the ASUS support site, or to the user manual of the heatsink/AIO cooler for steps on installing the heatsink/AIO cooler.

---

1. Prepare the CPU and CPU carrier.

---

**NOTE:** The CPU carrier is different for different CPUs, ensure to use the appropriate CPU carrier with the corresponding CPU. Failure to do so may cause damages to the CPU and CPU carrier.

---

2. Make sure the triangle marks on both the CPU and carrier bracket are aligned in the same corner, then attach the CPU to the carrier bracket. Ensure the CPU clicks firmly into the CPU carrier and that all the tabs of the CPU carrier are securing the CPU to the CPU carrier.

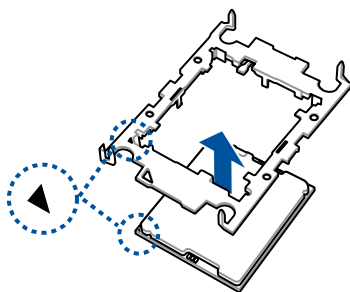

3. Apply the thermal paste to the CPU.
4. Attach the heatsink to the assembled CPU and carrier. Ensure the tabs on all four corners of the CPU carrier click firmly to the heatsink.

---

**NOTE:** The heatsink is purchased separately.

---

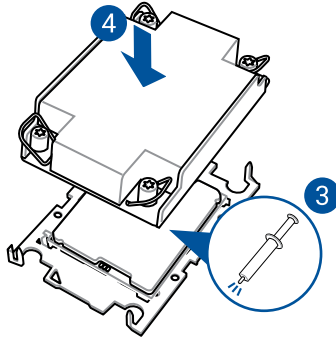

5. Rotate the four (4) nuts on the PNP cap counterclockwise then remove the nuts.

---

**CAUTION!** Keep the removed nuts in a safe place to prevent them from being misplaced or falling on the motherboard. Failure to do so may cause damages to your motherboard.

---

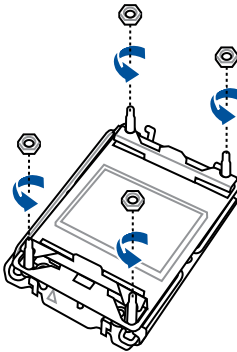

6. Press the two tabs on the PNP cap inwards, then lift and remove the PNP cap.

---

**CAUTION!** Be careful not to drop anything onto the socket after removing the PNP cap, as the pins on the socket may be damaged as a result.

---

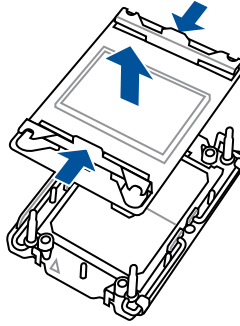

7. Push the lock latches inwards on all four corners of the heatsink.

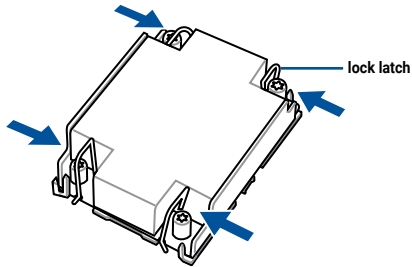

8. Align the CPU and heatsink assembly in the correct orientation so that the triangle marks on both the CPU carrier and socket are aligned in the same corner, then place the heatsink on top of the CPU socket.

9. Push the lock latches outwards on all four corners of the heatsink so that the heatsink and CPU assembly is secured to the CPU socket.

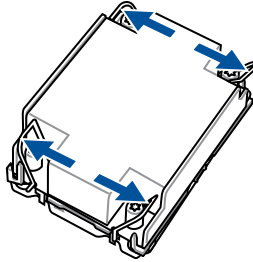

10. Tighten the four (4) screws on the heatsink.

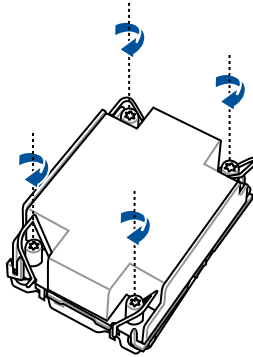

## 2.2 DIMM installation

1

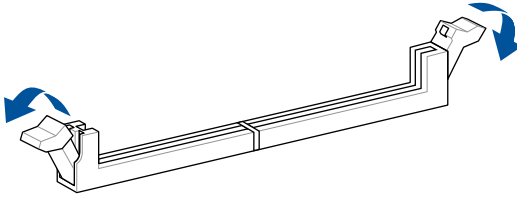

2

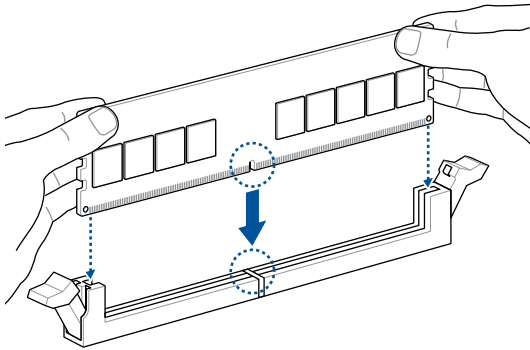

3

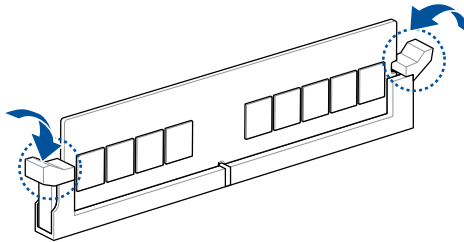

## DIMM removal

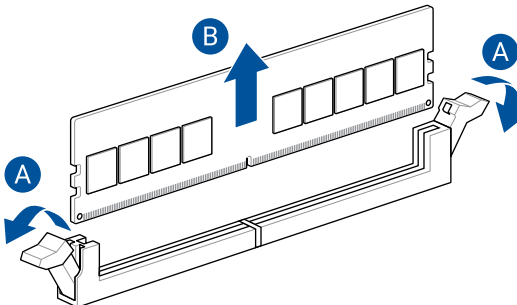

## 2.3 M.2 module installation

**NOTE:**

- The illustrations only show the installation steps for selected M.2 slots, the steps are the same for the other M.2 slots.
- Use a Phillips screwdriver when removing or installing the screws or screw stands mentioned in this section.
- If the thermal pad on the M.2 heatsink becomes damaged, we recommend replacing it with a thermal pad with a thickness of 1.25mm.
- Supported M.2 type varies per motherboard.

1. Press the tab downwards on the M.2 Q-Release to release the heatsink.

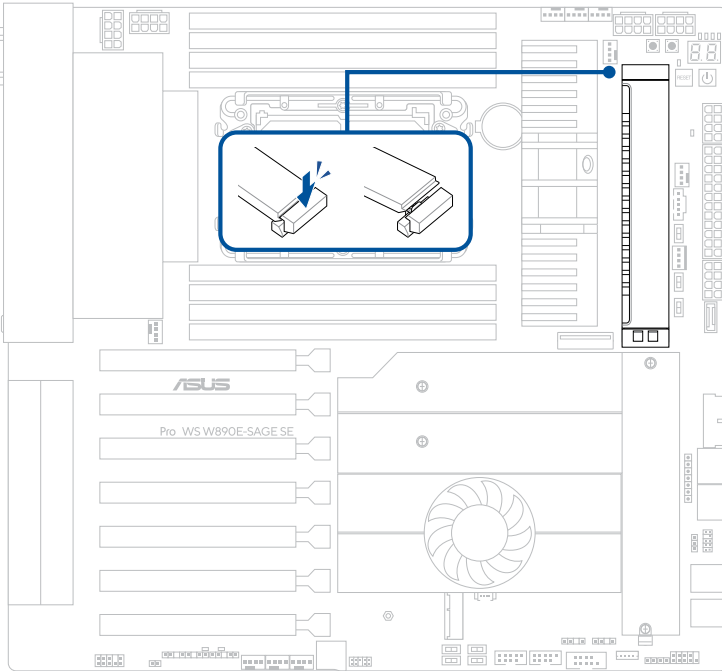

2. Pull the heatsink slightly outwards towards the tab, then lift and remove the heatsink.

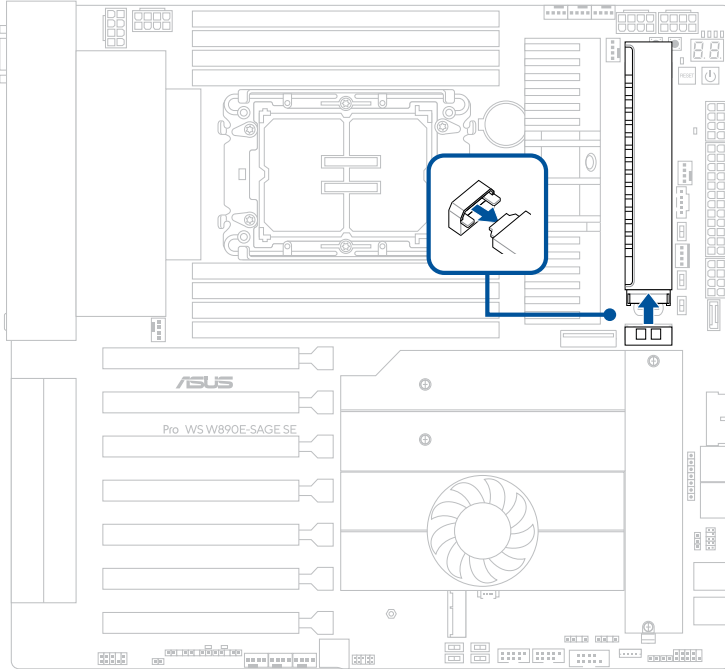

3. Loosen the screws from the M.2 heatsink.
4. Lift and remove the heatsink.

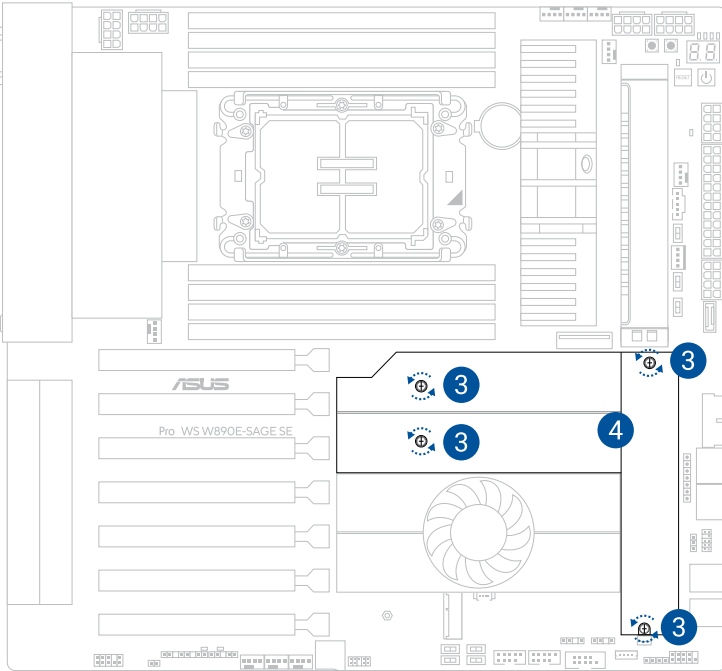

5. Install your M.2 module to the M.2 slot. The steps may differ between the different M.2 slots, please refer to the different installation steps below:

**Installing an 22110 M.2 module to 22110 length M.2 slot with backplate or 2280 M.2 module to 2280 length M.2 slot with backplate**

- A. (optional) If required, remove the pre-installed M.2 Q-Slide by pushing the M.2 Q-Slide all the way towards the M.2 slot then removing it from the M.2 backplate.

---

**NOTE:** Only 22110 length M.2 backplates come pre-installed with the M.2 Q-Slide.

---

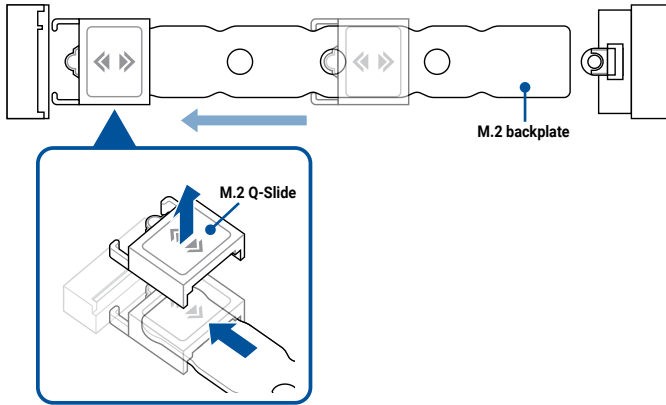

- B. (optional) Install the bundled M.2 rubber if you are installing a single sided M.2 module. DO NOT install the bundled M.2 rubber when installing a double-sided M.2 module.

---

**NOTE:**

- Only follow this step when the M.2 rubber comes bundled with your motherboard package.
  - Install the bundled M.2 rubber to the 2260 M.2 length screw hole.
- 

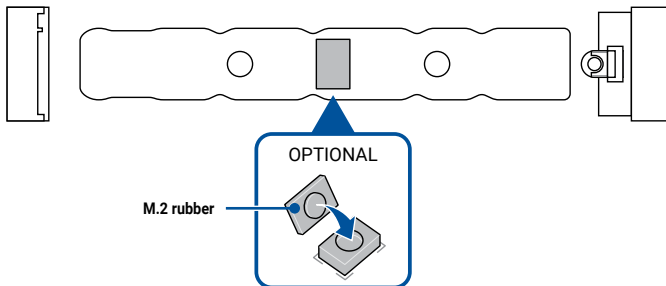

C. Remove the plastic film from the thermal pads on the M.2 backplate.

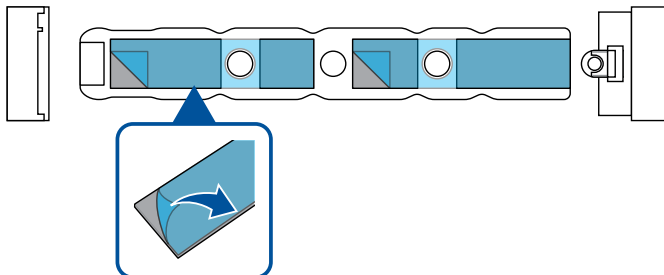

D. Install your M.2 module to the M.2 slot.

---

**IMPORTANT!** Ensure that there is nothing obstructing your M.2 module when installing the M.2 module to the M.2 slot.

---

E. Push the M.2 module down until it is secured by the M.2 Q-Latch.

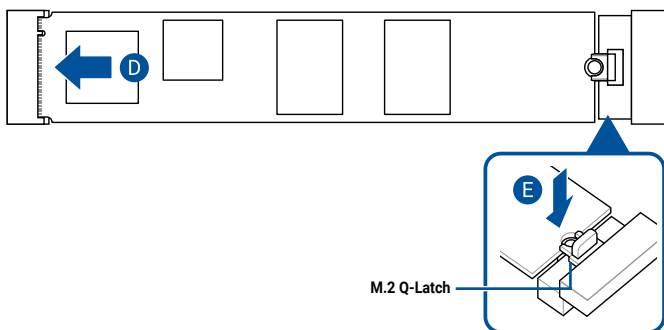

**Installing an 2280/2260/2242 M.2 module to M.2 slot with 22110 length M.2 backplate or 2260/2242 M.2 module to M.2 slot with 2280 length M.2 backplate**

- A. (optional) If required, install the bundled M.2 Q-Slide by attaching the M.2 Q-Slide to the end of the M.2 backplate closest to the M.2 slot, then pushing it along the M.2 backplate towards the M.2 Q-Latch.

---

**NOTE:** Only follow this step when:

- The M.2 Q-Slide comes bundled with your motherboard package.
  - The M.2 Q-Slide is not pre-installed to the M.2 backplate.
- 

- B. Push the M.2 Q-Slide to the M.2 length screw hole you wish to install your M.2 module to.

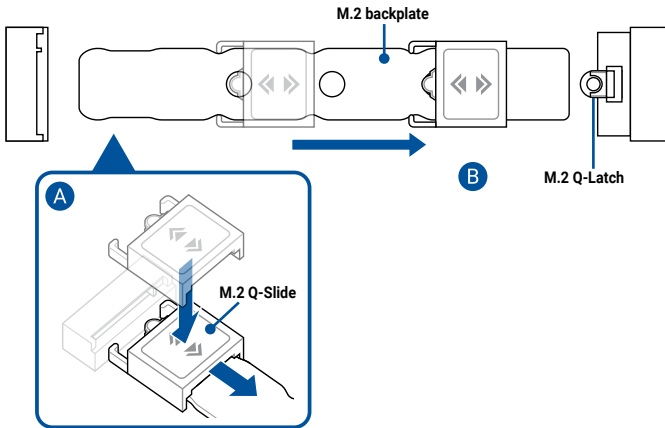

- C. (optional) Install the bundled M.2 rubber if you are installing a single sided M.2 module. DO NOT install the bundled M.2 rubber when installing a double-sided M.2 module.

**NOTE:**

- Only follow this step when:
  - Installing a 2280 or 2260 length M.2 module and
  - When the M.2 rubber comes bundled with your motherboard package.
- Install the bundled M.2 rubber to the:
  - 2260 M.2 length screw hole when installing a 2280 length M.2 module.
  - 2242 M.2 length screw hole when installing a 2260 length M.2 module.

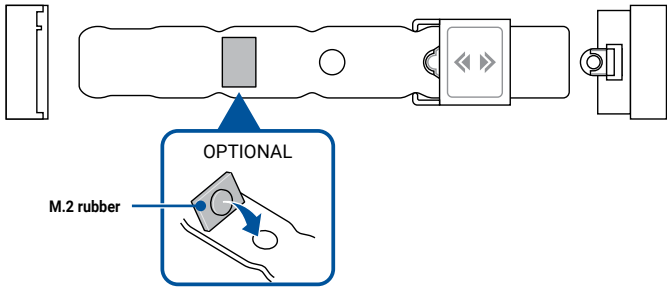

- D. Remove the plastic film from the thermal pads on the M.2 backplate.

**NOTE:** Adjust the M.2 Q-Slide if needed when removing the plastic film from the thermal pads.

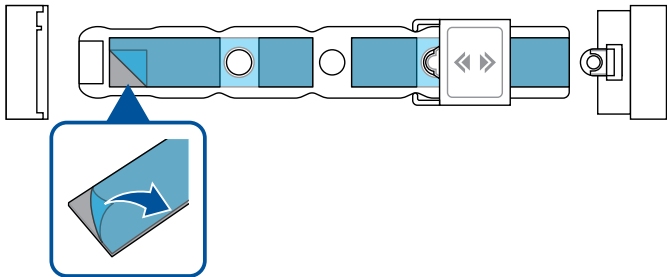

- E. Install your M.2 module to the M.2 slot.

---

**IMPORTANT!** Ensure that there is nothing obstructing your M.2 module when installing the M.2 module to the M.2 slot.

---

- F. Push the M.2 module down onto the M.2 Q-Slide until the M.2 module clicks into place and is secured by the M.2 Q-Slide.

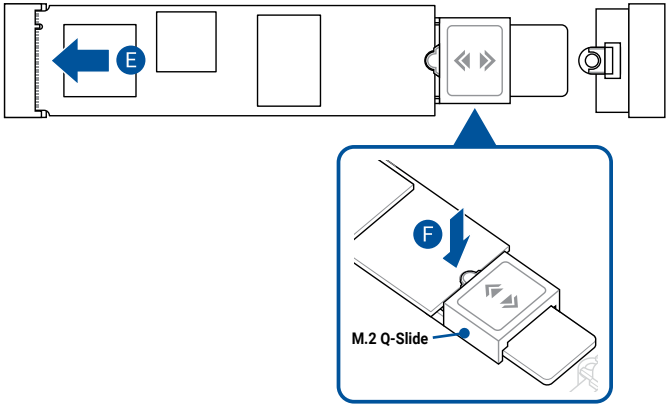

**Installing an M.2 module to M.2 slot without M.2 backplate**

- A. (optional) If required, remove the pre-installed removable M.2 Q-Latch screw at the 2280 length screw hole.

---

**NOTE:** Only follow this step if a removable M.2 Q-Latch screw is pre-installed at the 2280 length screw hole and can be removed.

---

- B. Remove the plastic film from the thermal pad.

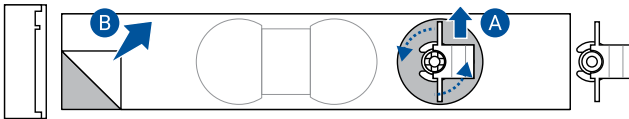

C. (optional) Remove the thermal pad of the M.2 length screw hole you wish to install your M.2 module to, then install the M.2 Q-Latch.

---

**NOTE:** You can use a bundled M.2 Q-Latch screw or a pre-installed removable M.2 Q-Latch screw.

---

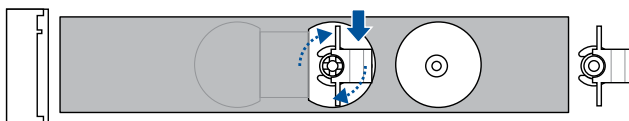

D. Install your M.2 module to the M.2 slot.

---

**IMPORTANT!** Ensure that there is nothing obstructing your M.2 module when installing the M.2 module to the M.2 slot.

---

E. Push the M.2 module down until it is secured by the M.2 Q-Latch.

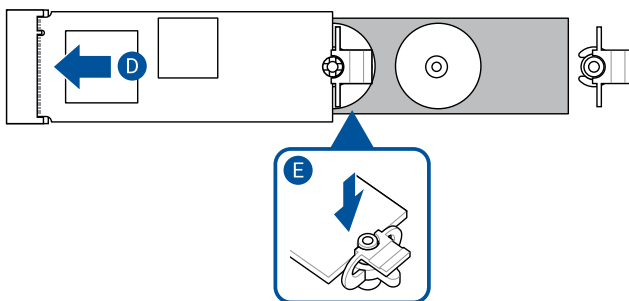

- (optional) Remove the plastic film from one side of the bundled thermal pad for 22110 M.2 Q-Release, then stick it onto the designated location on the bottom of the 22110 M.2 Q-Release.

**NOTE:** Only follow this step if installing 22110 length M.2 Q-Release and when the thermal pad for 22110 M.2 Q-Release comes bundled with your motherboard package.

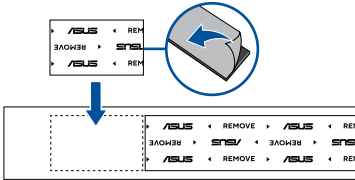

- Remove the plastic film from the thermal pads on the bottom of the heatsinks.

**NOTE:** If the thermal pad on the M.2 heatsink becomes damaged, we recommend replacing it with a thermal pad with a thickness of 1.25mm.

- Slide the heatsink into the slot on the end with the M.2 slot.
- Replace the heatsink.

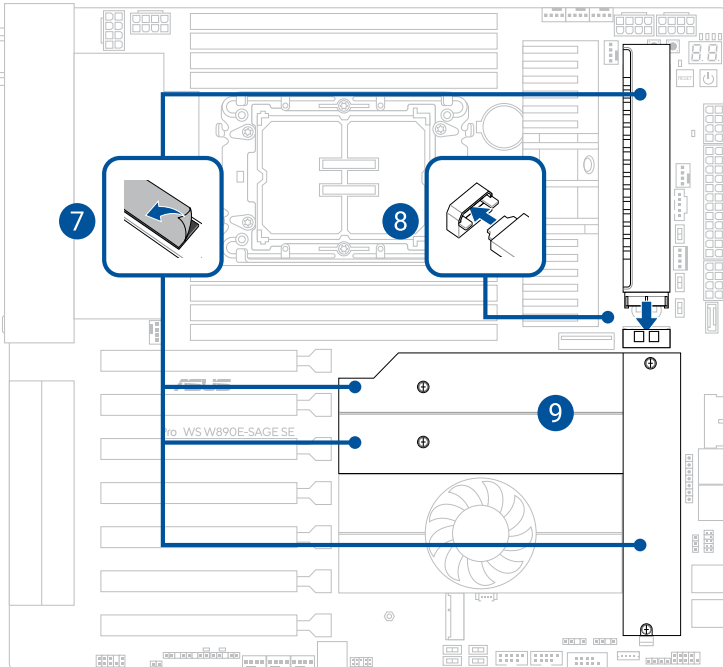

- 10. Press the heatsink down until it clicks into place and is secured.
- 11. Secure the heatsink using the screws on the heatsink.

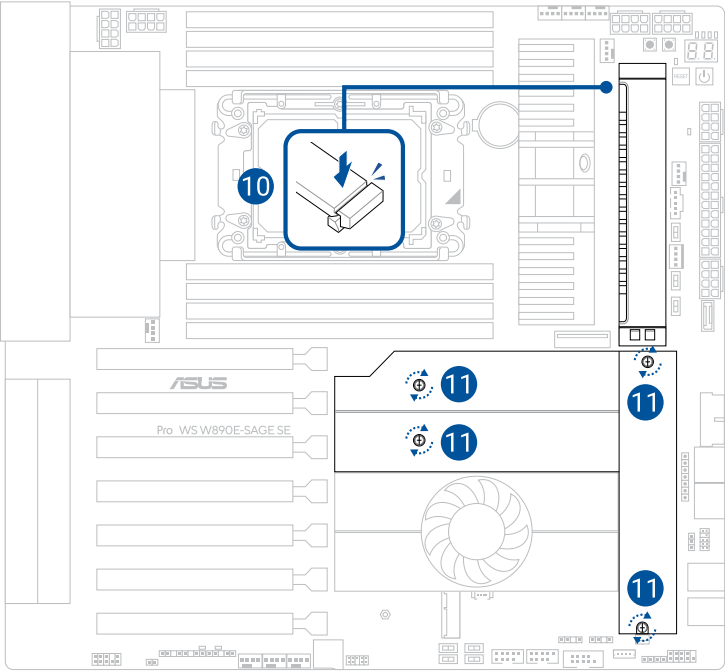

## 2.4 Additional cooling kit installation

### To install the Angleboost Fan Kit

The Angleboost Fan Kit is an innovative cooling solution that provides extra airflow to effectively cool down the MOS heatsink and closely placed RDIMM DDRs when they are under heavy workloads, please see the steps below for installation steps:

---

**NOTE:** The diagrams are for reference only.

---

1

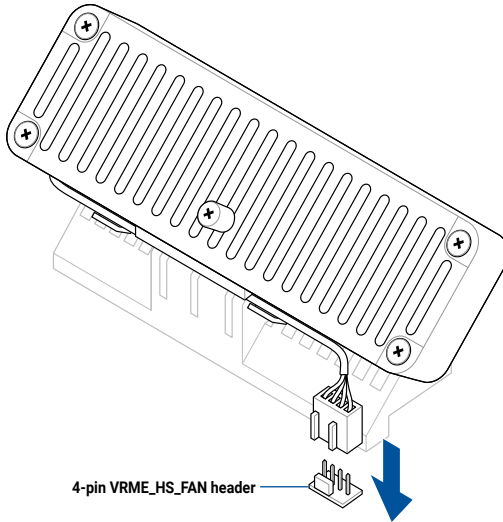

2

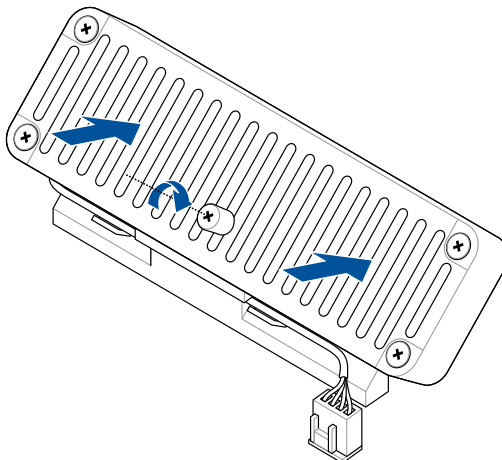

## 2.5 Motherboard installation

1. (on selected models) Install the bundled I/O Shield to the chassis rear I/O panel.

---

**NOTE:** Only install the I/O Shield if your motherboard does not have a pre-installed I/O shield.

---

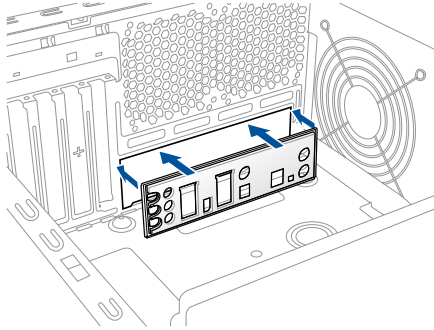

2. Place the motherboard into the chassis, ensuring that its rear I/O ports are aligned to the chassis' rear I/O panel.
3. Place nine (9) screws into the holes indicated by circles to secure the motherboard to the chassis.

---

**NOTE:** This instruction is for reference only, please place the amount of screws according to your installation situation.

---

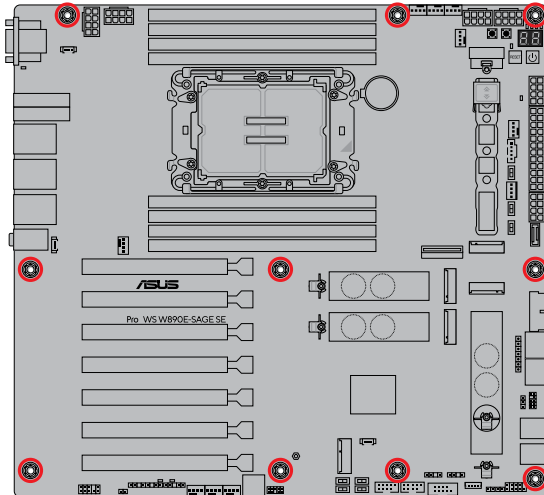

---

**CAUTION!** DO NOT over tighten the screws! Doing so can damage the motherboard.

---

## 2.6 Power connection

To avoid damages, please refer to the following configurations when installing the PSU(s).

### Single PSU installation

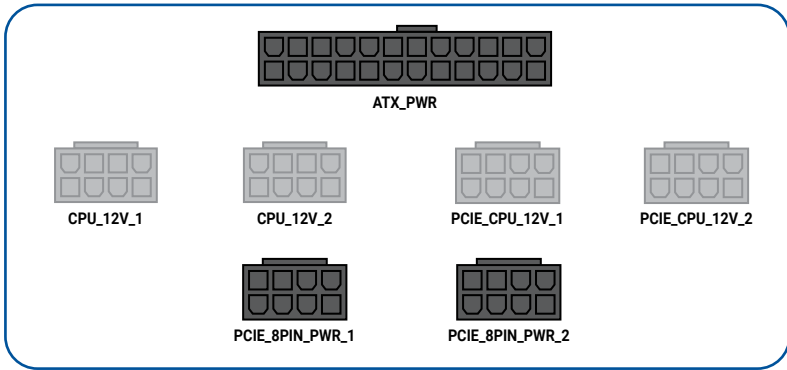

### Dual PSU configuration

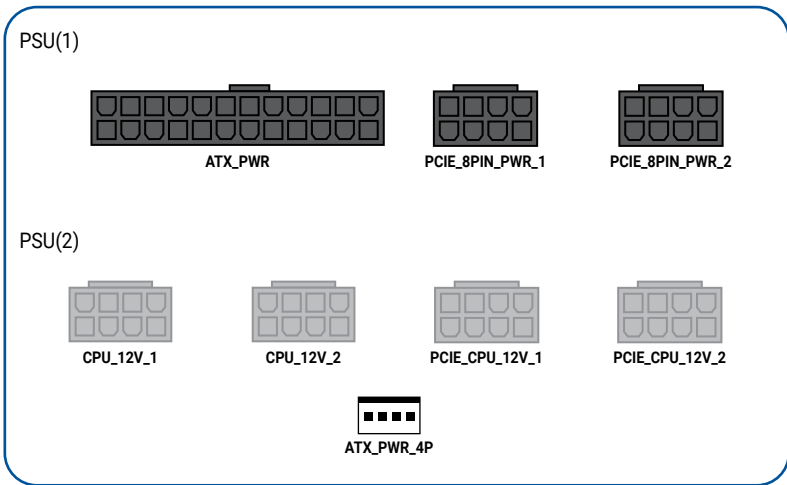

#### NOTE:

- Both PSUs used must be the same brand and model.
- Dual PSU configuration should only be used when overclocking.
- Ensure to use the bundled 4-pin to 24-pin adapter cable for ATX power connector when connecting PSU(2) to the ATX\_PWR\_4P connector.
- When using Dual PSU configuration, please use PSU(1) to power the discrete graphics card.

## 2.7 USB4® monitor connection

**NOTE:** Refer to the **USB4® and DisplayPort configuration** section on the next page for more details on the configurations available using the Mini DisplayPort IN and USB4® Type-C® ports.

1. Connect DisplayPort cable to the DisplayPort on a discrete graphic card and to the Mini DisplayPort IN port on the motherboard using a Mini DisplayPort IN to DisplayPort adapter cable

**NOTE:** Refer to section **Rear I/O connection** for the location of the Mini DisplayPort IN port.

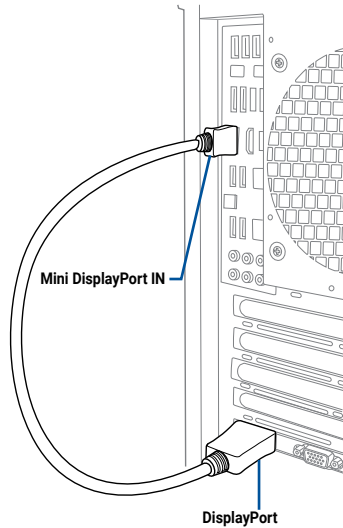

2. Connect a video capable USB Type-C® cable to a USB4® Type-C® port (USB4® Type-C® 40G USB 1 port or USB4® Type-C® 40G USB 2 port) on the motherboard and to a monitor featuring a USB Type-C® port.

### **IMPORTANT!**

- The USB4® port features the ASMedia ASM4242 controller and can support up to 40 Gb/s when USB4® devices are connected.
- Ensure to use a video capable USB Type-C® when connecting a monitor featuring a USB Type-C® port.

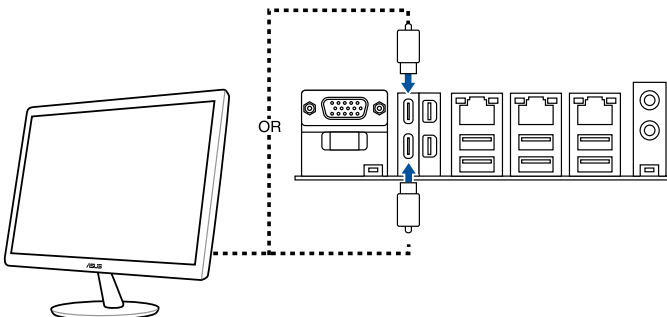

**NOTE:** USB4® Type-C® port can be connected to any USB Type-C® compatible display or device.

## USB4® and DisplayPort configuration

**CAUTION!** DO NOT hot swap the USB4® Type-C® 40G USB 1 port, and USB4® Type-C® 40G USB 2 port ports when your motherboard is powered on.

The tables below will list the USB4® and DisplayPort configurations.

### DisplayPort IN input to USB4® Type-C® output (Using a CPU without integrated graphics)

		USB4® Type-C® 40G USB 1 port	USB4® Type-C® 40G USB 2 port	Details
A	DP-IN 1 no input	-	-	Not supported.
	DP-IN 2 no input			
B	DP-IN 1 no input	-	V	Only USB4® Type-C® 40G USB 2 port has output. Output standard depends on the external graphics card.
	DP-IN 2 with input			
C	DP-IN 1 with input	V	-	Only USB4® Type-C® 40G USB 1 port has output. Output standard depends on the external graphics card.
	DP-IN 2 no input			
D	DP-IN 1 with input	V	V	Both USB4® Type-C® 40G USB 1 and USB4® Type-C® 40G USB 2 ports have output and output standards depend on the external graphics card.
	DP-IN 2 with input			

## 2.8 BIOS FlashBack™

BIOS FlashBack™ allows you to easily update the BIOS without entering the existing BIOS or operating system.

### To use BIOS FlashBack™:

1. Visit <https://www.asus.com/support/> and download the latest BIOS version for this motherboard.
2. Launch the **BIOSRenamer.exe** application to automatically rename the file or manually rename the file to the BIOS CAP filename specified in the **Specifications summary** section, then copy it to your USB storage device.

---

**NOTE:** The **BIOSRenamer.exe** application is zipped together with your BIOS file when you download a BIOS file for a BIOS FlashBack™ compatible motherboard.

---

3. Plug the 24-pin power connector to the motherboard and turn on the power supply (no need to power on the system). Insert the USB storage device to the USB port with BIOS FlashBack™ function.
4. Press the BIOS FlashBack™ button for three (3) seconds until the BIOS FlashBack™ LED blinks three times, indicating that the BIOS FlashBack™ function is enabled.

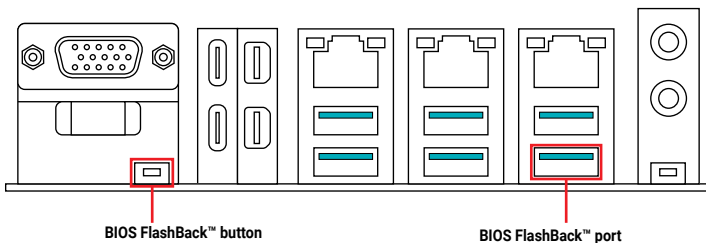

5. Wait until the light goes out, indicating that the BIOS updating process is completed.

---

**NOTE:** For more BIOS update utilities in BIOS setup, refer to **BIOS and RAID Support** section.

---

### CAUTION!

- Do not unplug portable disk, power system, press the Clear CMOS button, or short the CLRRTC header while BIOS update is ongoing, otherwise update will be interrupted. In case of interruption, please follow the steps again.
  - If the light flashes for five seconds and turns into a solid light, this means that the BIOS FlashBack™ is not operating properly. This may be caused by improper installation of the USB storage device and filename/file format error. If this scenario happens, please restart the system to turn off the light.
  - Updating BIOS may have risks. If the BIOS program is damaged during the process and results to the system's failure to boot up, please contact your local ASUS Service Center.
-

## 2.9 Clear CMOS button

The Clear CMOS button located on the rear I/O allows you to clear the Real Time Clock (RTC) RAM in the CMOS, which contains the date, time, system passwords, and system setup parameters.

To erase the RTC RAM:

1. Turn OFF the computer, then either unplug the power cord or switch the power supply's ON/OFF switch to the OFF position.
2. Press the Clear CMOS button.

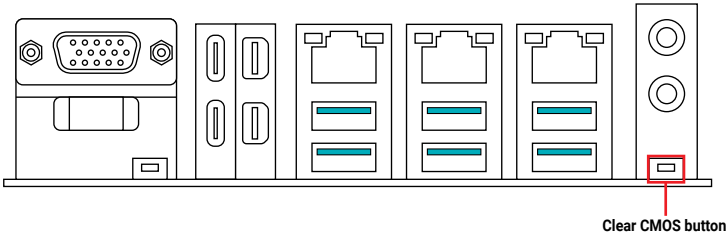

3. Plug in the power cord or switch the power supply's ON/OFF switch to the ON position, then turn ON the computer.
4. Hold down the <Del> key during the boot process and enter BIOS setup to re-enter data.

---

**CAUTION!** DO NOT press the Clear CMOS button except when clearing the RTC RAM, doing so will cause system boot failure!

---

## 2.10 Starting up for the first time

1. After making all the connections, replace the system case cover.
2. Ensure that all switches are off.
3. Connect the power cord to the power connector at the back of the system chassis.
4. Connect the power cord to a power outlet that is equipped with a surge protector.
5. Turn on the devices in the following order:
  - a. Monitor
  - b. External storage devices (starting with the last device on the chain)
  - c. System power
6. After applying power, the system power LED on the system front panel case lights up. For systems with ATX power supplies, the system LED lights up when you press the ATX power button. If your monitor complies with the “green” standards or if it has a “power standby” feature, the monitor LED may light up or change from orange to green after the system LED turns on.

The system then runs the power-on self tests (POST). While the tests are running, additional messages appear on the screen. If you do not see anything within 30 seconds from the time you turned on the power, the system may have failed a power-on test. Check the jumper settings and connections or call your retailer for assistance.
7. At power on, hold down the <Delete> key to enter the BIOS Setup. Follow the instructions in Chapter 3.

## 2.11 Turning off the computer

When the operating system is running and the power button is pressed, the system will enter Sleep, Hibernate, or Shut Down, depending on the OS settings. Pressing and holding the power button for more than four seconds will force the system to shut down, regardless of the OS settings. A forced shutdown should only be used when the system is unresponsive or when a normal shutdown cannot be performed. A forced shutdown places stress on the system and its electronic components. Repeated use of forced shutdown may lead to hardware failure, so please use it with caution.

# BIOS and RAID Support

---

**NOTE:** For more details on BIOS and RAID configurations, please refer to Manual & Document under the Support tab of the product information site, or visit <https://www.asus.com/support>.

---

## 3.1 Knowing UEFI BIOS

BIOS (Basic Input and Output System) stores system hardware settings such as storage device configuration, overclocking settings, advanced power management, and boot device configuration that are needed for system startup in the motherboard CMOS. In normal circumstances, the default BIOS settings apply to most conditions to ensure optimal performance. **DO NOT change the default BIOS settings** except in the following circumstances:

- An error message appears on the screen during the system bootup and requests you to run the BIOS Setup.
- You have installed a new system component that requires further BIOS settings or update.

---

**CAUTION!** Inappropriate BIOS settings may result to instability or boot failure. **We strongly recommend that you change the BIOS settings only with the help of a trained service personnel.**

---

**NOTE:** BIOS settings and options may vary due to different BIOS release versions. Please refer to the latest BIOS version for settings and options.

---

### Entering BIOS at startup

To enter BIOS Setup at startup, press <Delete> or <F2> during the Power-On Self Test (POST). If you do not press <Delete> or <F2>, POST continues with its routines.

---

#### **IMPORTANT!**

- If the system becomes unstable after changing any BIOS setting, load the default settings to ensure system compatibility and stability. Select the **Load Optimized Defaults** item under the **Exit** menu or press the <F5> hotkey.
  - If the system fails to boot after changing any BIOS setting, try to clear the CMOS and reset the motherboard to the default value.
  - The BIOS setup program does not support Bluetooth devices.
-

## 3.2 ASUS EZ Flash Utility

The ASUS EZ Flash Utility feature allows you to update the BIOS without using an OS-based utility.

---

**IMPORTANT!** Ensure to load the BIOS default settings to ensure system compatibility and stability. Select the **Load Optimized Defaults** item under the **Exit** menu or press hotkey **<F5>**.

---

### To update the BIOS:

---

**CAUTION!**

- This function can support devices such as a USB flash disk with FAT 32/16 format and single partition only.
  - DO NOT shut down or reset the system while updating the BIOS to prevent system boot failure!
- 

1. Insert the USB flash disk that contains the latest BIOS file to the USB port.
2. Enter the BIOS setup program, then go to the **Tool** menu to select **Start ASUS EzFlash** and press **<Enter>**.
3. Press the Left arrow key to switch to the **Drive** field.
4. Press the Up/Down arrow keys to find the USB flash disk that contains the latest BIOS, and then press **<Enter>**.
5. Press the Right arrow key to switch to the **Folder** field.
6. Press the Up/Down arrow keys to find the BIOS file, and then press **<Enter>** to perform the BIOS update process. Reboot the system when the update process is done.

### 3.3 ASUS CrashFree BIOS 3

The ASUS CrashFree BIOS 3 utility is an auto recovery tool that allows you to restore the BIOS file when it fails or gets corrupted during the updating process. You can restore a corrupted BIOS file using a USB flash drive that contains the BIOS file.

#### Recovering the BIOS

1. Download the latest BIOS version for this motherboard from <https://www.asus.com/support/>.
2. Rename the file using one of the following methods:
  - Launch the **BIOSRenamer.exe** application to automatically rename the file.
  - Manually rename the file to the BIOS CAP filename specified in the **Specifications summary** section.
  - Manually rename the file to **ASUS.CAP**.
3. Copy the renamed file to your USB storage device.
4. Insert the USB flash drive containing the BIOS file to a USB port.
5. Turn on the system.
6. The utility automatically checks the devices for the BIOS file. When found, the utility reads the BIOS file and enters ASUS EZ Flash Utility automatically.
7. The system requires you to enter BIOS Setup to recover the BIOS setting. To ensure system compatibility and stability, we recommend that you press <F5> to load default BIOS values.

---

**CAUTION!** DO NOT shut down or reset the system while updating the BIOS! Doing so can cause system boot failure!

---

## 3.4 RAID configurations

The motherboard supports RAID configurations.

### RAID definitions

**RAID 0 (Data striping)** optimizes two identical hard disk drives to read and write data in parallel, interleaved stacks. Two hard disks perform the same work as a single drive but at a sustained data transfer rate, double that of a single disk alone, thus improving data access and storage. Use of two new identical hard disk drives is required for this setup.

**RAID 1 (Data mirroring)** copies and maintains an identical image of data from one drive to a second drive. If one drive fails, the disk array management software directs all applications to the surviving drive as it contains a complete copy of the data in the other drive. This RAID configuration provides data protection and increases fault tolerance to the entire system. Use two new drives or use an existing drive and a new drive for this setup. The new drive must be of the same size or larger than the existing drive.

**RAID 5** stripes both data and parity information across three or more hard disk drives. Among the advantages of RAID 5 configuration include better HDD performance, fault tolerance, and higher storage capacity. The RAID 5 configuration is best suited for transaction processing, relational database applications, enterprise resource planning, and other business systems. Use a minimum of three identical hard disk drives for this setup.

**RAID 10** is data striping and data mirroring combined without parity (redundancy data) having to be calculated and written. With the RAID 10 configuration you get all the benefits of both RAID 0 and RAID 1 configurations. Use four new hard disk drives or use an existing drive and three new drives for this setup.

# Appendix

## Pro WS W890E-SAGE SE block diagram

### Intel® Xeon® 690/670/650 Series Processors

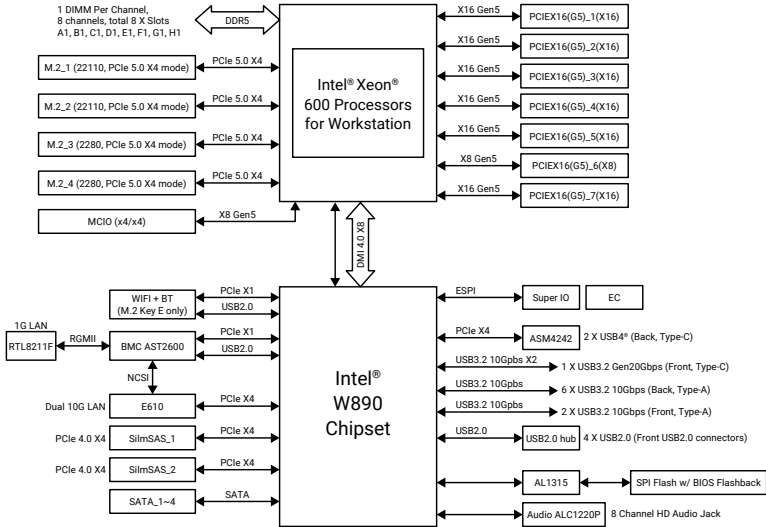

### Intel® Xeon® 630 Series Processor

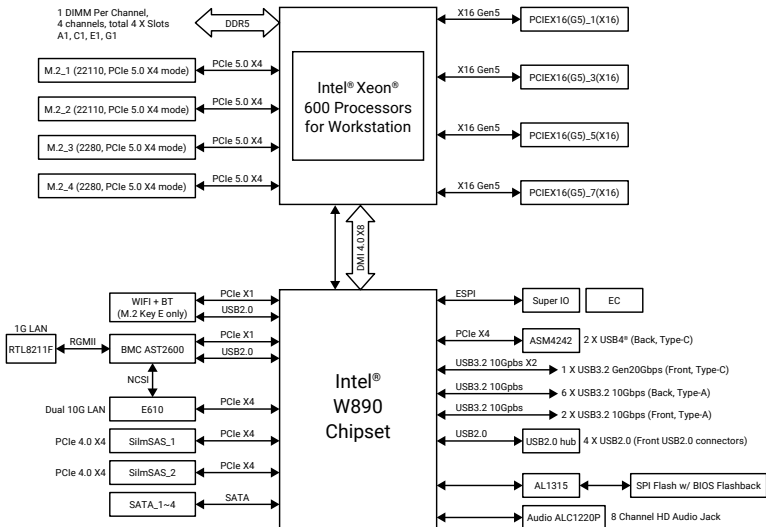

## Q-Code table

Code	Description
00	Not used
01	Power on. Reset type detection (soft/hard).
02	AP initialization before microcode loading
03	System Agent initialization before microcode loading
04	PCH initialization before microcode loading
06	Microcode loading
07	AP initialization after microcode loading
08	System Agent initialization after microcode loading
09	PCH initialization after microcode loading
0B	Cache initialization
0C – 0D	Reserved for future AMI SEC error codes
0E	Microcode not found
0F	Microcode not loaded
10	PEI Core is started
11 – 14	Pre-memory CPU initialization is started
15 – 18	Pre-memory System Agent initialization is started
19 – 1C	Pre-memory PCH initialization is started
2B – 2F	Memory initialization
30	Reserved for ASL (see ASL Status Codes section below)
31	Memory Installed
32 – 36	CPU post-memory initialization
37 – 3A	Post-Memory System Agent initialization is started
3B – 3E	Post-Memory PCH initialization is started
4F	DXE IPL is started
50 – 53	Memory initialization error. Invalid memory type or incompatible memory speed
54	Unspecified memory initialization error
55	Memory not installed
56	Invalid CPU type or Speed
57	CPU mismatch
58	CPU self test failed or possible CPU cache error
59	CPU micro-code is not found or micro-code update is failed
5A	Internal CPU error
5B	Reset PPI is not available
5C – 5F	Reserved for future AMI error codes

*(continued on the next page)*

## Q-Code table

Code	Description
E0	S3 Resume is started (S3 Resume PPI is called by the DXE IPL)
E1	S3 Boot Script execution
E2	Video repost
E3	OS S3 wake vector call
E4 – E7	Reserved for future AMI progress codes
E8	S3 Resume Failed
E9	S3 Resume PPI not Found
EA	S3 Resume Boot Script Error
EB	S3 OS Wake Error
EC – EF	Reserved for future AMI error codes
F0	Recovery condition triggered by firmware (Auto recovery)
F1	Recovery condition triggered by user (Forced recovery)
F2	Recovery process started
F3	Recovery firmware image is found
F4	Recovery firmware image is loaded
F5 – F7	Reserved for future AMI progress codes
F8	Recovery PPI is not available
F9	Recovery capsule is not found
FA	Invalid recovery capsule
FB – FF	Reserved for future AMI error codes
60	DXE Core is started
61	NVRAM initialization
62	Installation of the PCH Runtime Services
63 – 67	CPU DXE initialization is started
68	PCI host bridge initialization
69	System Agent DXE initialization is started
6A	System Agent DXE SMM initialization is started
6B – 6F	System Agent DXE initialization (System Agent module specific)
70	PCH DXE initialization is started
71	PCH DXE SMM initialization is started
72	PCH devices initialization
73 – 77	PCH DXE Initialization (PCH module specific)
78	ACPI module initialization
79	CSM initialization
7A – 7F	Reserved for future AMI DXE codes

*(continued on the next page)*

## Q-Code table

Code	Description
90	Boot Device Selection (BDS) phase is started
91	Driver connecting is started
92	PCI Bus initialization is started
93	PCI Bus Hot Plug Controller Initialization
94	PCI Bus Enumeration
95	PCI Bus Request Resources
96	PCI Bus Assign Resources
97	Console Output devices connect
98	Console input devices connect
99	Super IO Initialization
9A	USB initialization is started
9B	USB Reset
9C	USB Detect
9D	USB Enable
9E – 9F	Reserved for future AML codes
A0	IDE initialization is started
A1	IDE Reset
A2	IDE Detect
A3	IDE Enable
A4	SCSI initialization is started
A5	SCSI Reset
A6	SCSI Detect
A7	SCSI Enable
A8	Setup Verifying Password
A9	Start of Setup
AA	Reserved for ASL (see ASL Status Codes section below)
AB	Setup Input Wait
AC	Reserved for ASL (see ASL Status Codes section below)
AD	Ready To Boot event
AE	Legacy Boot event
AF	Exit Boot Services event
B0	Runtime Set Virtual Address MAP Begin
B1	Runtime Set Virtual Address MAP End
B2	Legacy Option ROM Initialization
B3	System Reset

*(continued on the next page)*

## Q-Code table

Code	Description
B4	USB hot plug
B5	PCI bus hot plug
B6	Clean-up of NVRAM
B7	Configuration Reset (reset of NVRAM settings)
B8–BF	Reserved for future AML codes
D0	CPU initialization error
D1	System Agent initialization error
D2	PCH initialization error
D3	Some of the Architectural Protocols are not available
D4	PCI resource allocation error. Out of Resources
D5	No Space for Legacy Option ROM
D6	No Console Output Devices are found
D7	No Console Input Devices are found
D8	Invalid password
D9	Error loading Boot Option (LoadImage returned error)
DA	Boot Option is failed (StartImage returned error)
DB	Flash update is failed
DC	Reset protocol is not available

### ACPI/ASL Checkpoints (under OS)

Code	Description
03	System is entering S3 sleep state
04	System is entering S4 sleep state
05	System is entering S5 sleep state
30	System is waking up from the S3 sleep state
40	System is waking up from the S4 sleep state
AC	System has transitioned into ACPI mode. Interrupt controller is in PIC mode.
AA	System has transitioned into ACPI mode. Interrupt controller is in APIC mode.

## General notices

### FCC Compliance Information

Responsible Party: Asus Computer International

Address: 48720 Kato Rd., Fremont, CA 94538, USA

Phone / Fax No: (510)739-3777 / (510)608-4555

This device complies with part 15 of the FCC Rules. Operation is subject to the following two conditions: (1) This device may not cause harmful interference, and (2) this device must accept any interference received, including interference that may cause undesired operation.

This equipment has been tested and found to comply with the limits for a Class B digital device, pursuant to part 15 of the FCC Rules. These limits are designed to provide reasonable protection against harmful interference in a residential installation. This equipment generates, uses and can radiate radio frequency energy and, if not installed and used in accordance with the instructions, may cause harmful interference to radio communications. However, there is no guarantee that interference will not occur in a particular installation. If this equipment does cause harmful interference to radio or television reception, which can be determined by turning the equipment off and on, the user is encouraged to try to correct the interference by one or more of the following measures:

- Reorient or relocate the receiving antenna.
- Increase the separation between the equipment and receiver.
- Connect the equipment into an outlet on a circuit different from that to which the receiver is connected.
- Consult the dealer or an experienced radio/TV technician for help.

### HDMI Trademark Notice

The terms HDMI, HDMI High-Definition Multimedia Interface, HDMI trade dress and the HDMI Logos are trademarks or registered trademarks of HDMI Licensing Administrator, Inc.



### 安全上のご注意

付属品は当該専用用品です。他の機器には使用しないでください。機器の破損もしくは、火災や感電の原因となることがあります。

### インターネット回線への接続に関するご注意

本製品は電気通信事業者（移动通信会社、固定通信会社、インターネットプロバイダ等）の通信回線（公衆無線LANを含む）に直接接続することができません。本製品をインターネットに接続する場合は、必ずルーター等を経由し接続してください。

## Australia statement notice

From 1 January 2012 updated warranties apply to all ASUS products, consistent with the Australian Consumer Law. For the latest product warranty details please visit <https://www.asus.com/support/>. Our goods come with guarantees that cannot be excluded under the Australian Consumer Law. You are entitled to a replacement or refund for a major failure and compensation for any other reasonably foreseeable loss or damage. You are also entitled to have the goods repaired or replaced if the goods fail to be of acceptable quality and the failure does not amount to a major failure.

If you require assistance please call ASUS Customer Service 1300 2787 88 or visit us at <https://www.asus.com/support/>.

## Declaration of compliance for product environmental regulation

ASUS follows the green design concept to design and manufacture our products, and makes sure that each stage of the product life cycle of ASUS product is in line with global environmental regulations. In addition, ASUS disclose the relevant information based on regulation requirements.

Please refer to <https://esg.asus.com/Compliance.htm> for information disclosure based on regulation requirements ASUS is complied with:

### EU REACH and Article 33

Complying with the REACH (Registration, Evaluation, Authorisation, and Restriction of Chemicals) regulatory framework, we published the chemical substances in our products at ASUS REACH website at <https://esg.asus.com/Compliance.htm>.

### EU RoHS

This product complies with the EU RoHS Directive. For more details, see <https://esg.asus.com/Compliance.htm>

### India RoHS

This product complies with the "India E-Waste (Management) Rules, 2016" and prohibits use of lead, mercury, hexavalent chromium, polybrominated biphenyls (PBBs) and polybrominated diphenyl ethers (PBDEs) in concentrations exceeding 0.1% by weight in homogenous materials and 0.01% by weight in homogenous materials for cadmium, except for the exemptions listed in Schedule II of the Rule.

### Vietnam RoHS

ASUS products sold in Vietnam, on or after September 23, 2011, meet the requirements of the Vietnam Circular 30/2011/TT-BCT.

Các sản phẩm ASUS bán tại Việt Nam, vào ngày 23 tháng 9 năm 2011 trở về sau, đều phải đáp ứng các yêu cầu của Thông tư 30/2011/TT-BCT của Việt Nam.

### Türkiye RoHS

AEEE Yönetmeliğine Uygundur

### ASUS Recycling/Takeback Services

ASUS recycling and takeback programs come from our commitment to the highest standards for protecting our environment. We believe in providing solutions for you to be able to responsibly recycle our products, batteries, other components as well as the packaging materials. Please go to <https://esg.asus.com/en/Takeback.htm> for detailed recycling information in different regions.



The Waste Electrical and Electronic Equipment (WEEE) Directive (Directive 2012/19/EU) is a European Union law that aims to reduce the environmental impact of electrical and electronic equipment. It mandates producers to take responsibility for the end-of-life management of their products, promoting collection, treatment, and recycling to minimize waste and encourage resource recovery.

Do not throw your electrical and electronic equipment in municipal waste.

The symbol of the crossed-out wheeled bin on the product or packaging indicates that this product (including any batteries it contains) must not be disposed of with your household waste.

To prevent potential harm to the environment and human health, a collection framework should be used to return, recycle, and recover waste electrical and electronic equipment (WEEE), and this product has been designed to enable the reuse of parts and facilitate the recycling of certain materials.

Improper disposal may involve risks due to the presence of hazardous substances within electrical and electronic equipment, such as lead and BFR and other harmful components.

Check your local recycling services for electronic products.

(<https://esg.asus.com/en/circular-economy/resource-regeneration/global-take-back-service>)



Do not throw the battery in municipal waste. The symbol of the crossed out wheeled bin indicates that the battery should not be placed in municipal waste.

Please see and scan below for multi-language update on the WEEE directive and battery disposal:

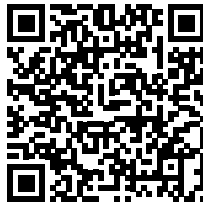

## France sorting and recycling information



**FR**  
Cet appareil  
et ses accessoires  
se recyclent

À DÉPOSER  
EN MAGASIN

À DÉPOSER  
EN DÉCHÈTERIE

OU

Points de collecte sur [www.quefairedemesdechets.fr](http://www.quefairedemesdechets.fr)  
Privilégiez la réparation ou le don de votre appareil !

# Notices for non Wi-Fi model

## Compliance Statement of Innovation, Science and Economic Development Canada (ISED)

This device complies with Innovation, Science and Economic Development Canada licence exempt RSS standard(s). Operation is subject to the following two conditions: (1) this device may not cause interference, and (2) this device must accept any interference, including interference that may cause undesired operation of the device.

CAN ICES(B)/NMB(B)

## Déclaration de conformité de Innovation, Sciences et Développement économique Canada (ISED)

Le présent appareil est conforme aux CNR d'Innovation, Sciences et Développement économique Canada applicables aux appareils radio exempts de licence. L'exploitation est autorisée aux deux conditions suivantes : (1) l'appareil ne doit pas produire de brouillage, et (2) l'utilisateur de l'appareil doit accepter tout brouillage radioélectrique subi, même si le brouillage est susceptible d'en compromettre le fonctionnement.

CAN ICES(B)/NMB(B)

## Simplified UKCA Declaration of Conformity

ASUSTeK Computer Inc. hereby declares that this device is in compliance with the essential requirements and other relevant provisions of related UKCA Directives. Full text of UKCA declaration of conformity is available at: [www.asus.com/support](http://www.asus.com/support)

## Simplified EU Declaration of Conformity

**English** ASUSTeK Computer Inc. hereby declares that this device is in compliance with the essential requirements and other relevant provisions of related Directives. Full text of EU declaration of conformity is available at: [www.asus.com/support](http://www.asus.com/support)

**Français** AsusTek Computer Inc. déclare par la présente que cet appareil est conforme aux critères essentiels et autres clauses pertinentes des directives concernées. La déclaration de conformité de l'UE peut être téléchargée à partir du site Internet suivant : [www.asus.com/support](http://www.asus.com/support)

**Deutsch** ASUSTeK Computer Inc. erklärt hiermit, dass dieses Gerät mit den wesentlichen Anforderungen und anderen relevanten Bestimmungen der zugehörigen Richtlinien übereinstimmt. Der gesamte Text der EU-Konformitätserklärung ist verfügbar unter: [www.asus.com/support](http://www.asus.com/support)

**Italiano** ASUSTeK Computer Inc. con la presente dichiara che questo dispositivo è conforme ai requisiti essenziali e alle altre disposizioni pertinenti del direttive correlate. Il testo completo della dichiarazione di conformità UE è disponibile all'indirizzo: [www.asus.com/support](http://www.asus.com/support)

**Русский** Компания ASUS заявляет, что это устройство соответствует основным требованиям и другим соответствующим условиям соответствующих директив. Подробную информацию, пожалуйста, смотрите на [www.asus.com/support](http://www.asus.com/support)

**Български** С настоящото ASUSTeK Computer Inc. декларира, че това устройство е в съответствие със съществените изисквания и другите приложими постановления на свързаните директиви. Пълният текст на декларацията за съответствие на ЕС е достъпна на адрес: [www.asus.com/support](http://www.asus.com/support)

**Hrvatski** ASUSTeK Computer Inc. ovim izjavljuje da je ovaj uređaj sukladan s bitnim zahtjevima i ostalim odgovarajućim odredbama vezanih direktiva. Cijeli tekst EU izjave o sukladnosti dostupan je na: [www.asus.com/support](http://www.asus.com/support)

**Čeština** Společnost ASUSTeK Computer Inc. tímto prohlašuje, že toto zařízení splňuje základní požadavky a další příslušná ustanovení souvisejících směrnic. Plné znění prohlášení o shodě EU je k dispozici na adrese: [www.asus.com/support](http://www.asus.com/support)

**Dansk** ASUSTeK Computer Inc. erklærer hermed, at denne enhed er i overensstemmelse med hovedkravene og andre relevante bestemmelser i de relaterede direktiver. Hele EU-overensstemmelseserklæringen kan findes på: [www.asus.com/support](http://www.asus.com/support)

**Nederlands** ASUSTeK Computer Inc. verklaart hierbij dat dit apparaat voldoet aan de essentiële vereisten en andere relevante bepalingen van de verwante richtlijnen. De volledige tekst van de EU-verklaring van conformiteit is beschikbaar op: [www.asus.com/support](http://www.asus.com/support)

**Eesti** Käesolevaga kinnitab ASUSTeK Computer Inc. et see seade vastab asjakohaste direktiivide oluliste nõuetele ja teistele asjassepuutuvatele sätetele. EL vastavusdeklaratsiooni täielik tekst on saadaval järgmisel aadressil: [www.asus.com/support](http://www.asus.com/support)

**Suomi** ASUSTeK Computer Inc. ilmoittaa täten, että tämä laite on asiaankuuluvien direktiivien olennaisten vaatimusten ja muiden tätä koskevien säästösten mukainen. EU-yhdenmukaisuusilmoituksen koko teksti on luettavissa osoitteessa: [www.asus.com/support](http://www.asus.com/support)

**Ελληνικά** Με το παρόν, η ASUSTeK Computer Inc. δηλώνει ότι αυτή η συσκευή συμμορφώνεται με τις θεμελιώδεις απαιτήσεις και άλλες σχετικές διατάξεις των οδηγιών της ΕΕ. Το πλήρες κείμενο της δήλωσης συμμορφότητας είναι διαθέσιμο στη διεύθυνση: [www.asus.com/support](http://www.asus.com/support)

**Magyar** Az ASUSTeK Computer Inc. ezennel kijelenti, hogy ez az eszköz megfelel a kapcsolódó irányelvek lényeges követelményeinek és egyéb vonatkozó rendelkezésének. Az EU megfeleléségi nyilatkozat teljes szövege innen letölthető: [www.asus.com/support](http://www.asus.com/support)

**Latviski** ASUSTeK Computer Inc. ar šo paziņo, ka šī ierīce atbilst saistīto Direktīvu būtiskajām prasībām un citiem citiem saistošajiem nosacījumiem. Pilns ES atbilstības paziņojuma teksts pieejams šeit: [www.asus.com/support](http://www.asus.com/support)

**Lietuvių** „ASUSTeK Computer Inc.“ šiuo tvirtina, kad šis įrenginys atitinka pagrindinius reikalavimus ir kitas svarbias susijusių direktyvų nuostatas. Visą ES atitikties deklaracijos tekstą galima rasti: [www.asus.com/support](http://www.asus.com/support)

**Norsk** ASUSTeK Computer Inc. erklærer herved at denne enheten er i samsvar med hovedsaklige krav og andre relevante forskrifter i relaterte direktiver. Fullstendig tekst for EU-samsvarserklæringen finnes på: [www.asus.com/support](http://www.asus.com/support)

**Polski** Firma ASUSTeK Computer Inc. niniejszym oświadcza, że urządzenie to jest zgodne z zasadniczymi wymogami i innymi właściwymi postanowieniami powiązanych dyrektyw. Pełny tekst deklaracji zgodności UE jest dostępny pod adresem: [www.asus.com/support](http://www.asus.com/support)

**Português** A ASUSTeK Computer Inc. declara que este dispositivo está em conformidade com os requisitos essenciais e outras disposições relevantes das Diretivas relacionadas. Texto integral da declaração da UE disponível em: [www.asus.com/support](http://www.asus.com/support)

**Română** ASUSTeK Computer Inc. declară că acest dispozitiv se conformează cerințelor esențiale și altor prevederi relevante ale directivelor conexe. Textul complet al declarației de conformitate a Uniunii Europene se găsește la: [www.asus.com/support](http://www.asus.com/support)

**Srpski** ASUSTeK Computer Inc. ovim izjavljuje da je ovaj uređaj u saglasnosti sa osnovnim zahtevima i drugim relevantnim odredbama povezanih Direktiva. Pun tekst EU deklaracije o usaglašenosti je dostupan da adresi: [www.asus.com/support](http://www.asus.com/support)

**Slovensky** Spoločnosť ASUSTeK Computer Inc. týmto vyhlasuje, že toto zariadenie vyhovuje základným požiadavkám a ostatným príslušným ustanoveniam príslušných smerníc. Celý text vyhlásenia o zhode pre štáty EÚ je dostupný na adrese: [www.asus.com/support](http://www.asus.com/support)

**Slovenščina** ASUSTeK Computer Inc. izjavlja, da je ta naprava skladna z bistvenimi zahtevami in drugimi ustreznimi določbami povezanih direktiv. Celotno besedilo EU-izjave o skladnosti je na voljo na spletnem mestu: [www.asus.com/support](http://www.asus.com/support)

**Español** Por la presente, ASUSTeK Computer Inc. declara que este dispositivo cumple los requisitos básicos y otras disposiciones pertinentes de las directivas relacionadas. El texto completo de la declaración de la UE de conformidad está disponible en: [www.asus.com/support](http://www.asus.com/support)

**Svenska** ASUSTeK Computer Inc. förklarar härmed att denna enhet överensstämmer med de grundläggande kraven och andra relevanta föreskrifter i relaterade direktiv. Fulltext av EU-försäkran om överensstämmelse finns på: [www.asus.com/support](http://www.asus.com/support)

**Türkçe** ASUSTeK Computer Inc., bu aygıtın temel gereksinimlerle ve ilişkili Yönergelerin diğer ilgili koşullarına uyumlu olduğunu beyan eder. AB uygunluk bildiriminin tam metni şu adreste bulunabilir: [www.asus.com/support](http://www.asus.com/support)

**Українська** ASUSTeK Computer Inc. заявляє, що цей пристрій відповідає основним вимогам та іншим відповідним положенням відповідних Директив. Повний текст декларації відповідності стандартам ЄС доступний на: [www.asus.com/support](http://www.asus.com/support)

**Bosnian** ASUSTeK Computer Inc. ovim izjavljuje da je ovaj uređaj usklađen sa bitnim zahtjevima i ostalim odgovarajućim odredbama vezanih direktiva. Kompletan tekst EU deklaracije o usklađenosti dostupan je na: [www.asus.com/support](http://www.asus.com/support)

**עברית** בזאת, ASUSTeK Computer Inc. משריר כי תואם לדרשות החיוביות ולתנאים הרלוונטיים האחרים של החיוביות הקשורות. הטקסט המלא של הצהרת התאימות של האיחוד האירופי זמין בכתובת: [www.asus.com/support](http://www.asus.com/support)

# Warranty

## EN: ASUS Guarantee Information

- ASUS offers a voluntary manufacturer's Commercial Guarantee.
- ASUS reserves the right to interpret the provisions of the ASUS Commercial Guarantee.
- This ASUS Commercial Guarantee is provided independently and in addition to the statutory Legal Guarantee and in no way affects or limits the rights under the Legal Guarantee.

For all the guarantee information, please visit <https://www.asus.com/support>.

## F: Garantie ASUS

- ASUS fournit une garantie commerciale en tant que garantie volontaire du fabricant.
- ASUS se réserve le droit d'interpréter et de clarifier les informations relatives à la garantie commerciale ASUS.
- Cette garantie commerciale ASUS est fournie indépendamment et parallèlement à la garantie légale, elle n'affecte ou ne limite d'aucune façon les droits acquis par la garantie légale.

Pour plus d'informations sur la garantie, consultez le site <https://www.asus.com/fr/support/>.

## G: ASUS Garantieinformationen

- ASUS bietet eine freiwillige Warengarantie des Herstellers an.
- ASUS behält sich das Recht zur Auslegung der Bestimmungen in der ASUS Warengarantie vor.
- Diese ASUS Warengarantie wird unabhängig und zusätzlich zur rechtmäßigen gesetzlichen Garantie gewährt und beeinträchtigt oder beschränkt in keiner Weise die Rechte aus der gesetzlichen Garantie.

Die vollständigen Garantieinformationen finden Sie unter <https://www.asus.com/de/support/>.

## I: Informativa sulla Garanzia ASUS

- ASUS offre una Garanzia Commerciale volontaria del produttore.
- ASUS si riserva il diritto di interpretare le disposizioni della Garanzia Commerciale ASUS.
- La presente Garanzia Commerciale ASUS viene fornita in modo indipendente e in aggiunta alla Garanzia Legale prevista per legge e non pregiudica o limita in alcun modo i diritti previsti dalla Garanzia Legale.

Per tutte le informazioni sulla garanzia, visitate <https://www.asus.com/it/support>.

## R: Информация о гарантии ASUS

- ASUS предлагает добровольную гарантию от производителя.
- ASUS оставляет за собой право интерпретирование положений гарантии ASUS.
- Настоящая гарантия ASUS никоим образом не ограничивает Ваши права, предусмотренные локальным законодательством.

Для получения полной информации о гарантии посетите <https://www.asus.com/ru/support/>.

## BG: Информация за гаранцията от ASUS

- ASUS предлага доброволна търговска гаранция от производителя.
- ASUS си запазва правото да тълкува условията на търговската гаранция на ASUS.
- Тази търговска гаранция на ASUS се предлага независимо от и в допълнение на законовата гаранция. Тя по никакъв начин не оказва влияние върху правата на потребителя в законовата гаранция и по никакъв начин не ги ограничава.

За цялостна информация относно гаранцията, моля, посетете <https://www.asus.com/support>.

## CR: Informacije o ASUS jamstvu

- ASUS dragovoljno nudi komercijalno proizvođačko jamstvo.
- ASUS zadržava prava na tumačenje odredbi ASUS komercijalnog jamstva.
- Ovo ASUS komercijalno jamstvo daje se neovisno i kao dodatak zakonskom jamstvu i na koji način ne ograničuje prava iz okvira zakonskog jamstva.

Sve informacije o jamstvu potražite na <https://www.asus.com/support>.

## CZ: Informace o záruce společnosti ASUS

- Společnost ASUS nabízí dobrovolnou komerční záruku výrobce.
- Společnost ASUS si vyhrazuje právo vykládat ustanovení komerční záruky společnosti ASUS.
- Tato komerční záruka společnosti ASUS je poskytována nezávisle a jako doplněk zákonné záruky a žádným způsobem neovlivňuje ani neomezuje práva vyplývající ze zákonné záruky.

Všechny informace o záruce najdete na adrese <https://www.asus.com/cz/support/>.

## DA: ASUS garantioplysninger

- ASUS tilbyder en valgfri handelsmæssig garanti.
- ASUS forbeholder sig retten til at fortolke bestemmelserne i ASUS' handelsmæssige garanti.
- Denne handelsmæssige garanti fra ASUS tilbydes uafhængigt, som en tilføjelse til den lovbestemte juridiske garanti og den påvirkning eller begrænsning på ingen måde rettighederne i den juridiske garanti.

Alle garantioplysningerne kan findes på <https://www.asus.com/dk/support/>.

## DU: ASUS-garantie-informatie

- ASUS biedt een vrijwillige commerciële garantie van de fabrikant.
- ASUS behoudt zich het recht voor om de bepalingen van de commerciële garantie van ASUS uit te leggen.
- Deze commerciële garantie van ASUS wordt onafhankelijk en als aanvulling op de statutaire Wettelijke garantie geboden en beïnvloedt of beperkt in geen geval de rechten onder de wettelijke garantie.

Voor alle informatie over de garantie, gaat u naar <https://www.asus.com/nl/support/>.

## EE: Teave ASUS-e garantii kohta

- ASUS pakub vabatahtlikku tasulist tootjagarantiid.
- ASUS jätab endale õiguse tõlgendada ASUS-e tasulise garantii tingimusi.
- See ASUS-e tasuline garantiid on sõltumatu lisagarantii seadusega kehtestatud garantiile ega mõjuta mingil määral seadusega kehtestatud garantiid ning seadusega kehtestatud garantiid piiranguid.

Vaadake garantiiga seotud teavet veebisaidilt <https://www.asus.com/ee/>.

## FI: ASUS-takuutiedot

- ASUS tarjoaa vapaaehtoisena valmistajan kaupallisen takuun.
- ASUS pidättää oikeuden tulkita ASUS-kaupallisen takuun ehdot.
- Tämä ASUS-kaupallinen takuu tarjotaan itsenäisesti lakisääteisen oikeudellisen takuun lisäksi eikä se vaikuta millään tavoin laillisen takuun oikeuksiin tai rajoita niitä.

Saadaksesi kaikki takuutiedot, siirry osoitteeseen <https://www.asus.com/fi/support>.

## GK: Πληροφορίες εγγύησης ASUS

- Η ASUS προσφέρει μια εθελοντική Εμπορική εγγύηση κατασκευαστή.
- Η ASUS διατηρεί το δικαίωμα ερμηνείας των διατάξεων της Εμπορικής εγγύησης ASUS.
- Αυτή η Εμπορική εγγύηση ASUS παρέχεται ανεξάρτητα και επιπροσθέτως της θεσμικής Νομικής εγγύησης και σε καμία περίπτωση δεν επηρεάζει ή περιορίζει τα δικαιώματα βάσει της Νομικής εγγύησης.

Για όλες τις πληροφορίες εγγύησης, επισκεφθείτε τη διεύθυνση <https://www.asus.com/gr-el/>.

## HUG: ASUS garanciālis informācija

- Az ASUS önkéntes gyártói kereskedelmi garanciát kínál.
- Az ASUS fenntartja magának a jogot, hogy értelmezze az ASUS kereskedelmi garanciára vonatkozó rendelkezéseket.
- Ezt a kereskedelmi garanciát az ASUS függetlenül és a törvényes garancia mellett nyújtja és semmilyen módon nem befolyásolja, vagy korlátozza a jogi garancia nyújtotta jogokat.

A garanciára vonatkozó teljes körű információért látogasson el a <https://www.asus.com/hu/support/oldalra>.

## LT: Informacija apie ASUS garantiją

- ASUS siūlo savanorišką komercinį gamintojo garantiją.
- ASUS pasilieka teisę savo nuožiumi aiškinti šios komercinės ASUS garantijos nuostatas.
- Ši komercinė ASUS garantija suteikiama nepriklausoma, be įstatymines teisinės garantijos, ir jokiu būdu nepaveikia ar neapriboja teisinės garantijos suteikiamų teisių.

Norėdami gauti visą informaciją apie garantiją, apsilankykite <https://www.asus.com/lt/>.

## LV: ASUS garantijas informācija

- ASUS piedāvā brīvprātīgu ražotāja komerciālo garantiju.
- ASUS patur tiesības interpretēt ASUS komerciālās garantijas noteikumus.
- Šī ASUS komerciālā garantija tiek piedāvāta neatkarīgi un papildus likumā noteiktajai juridiskajai garantijai, un tā nekādā veidā neietekmē vai neierobežo juridiskajai garantijai noteiktās tiesības.

Lai iegūtu informāciju par garantiju, apmeklējiet vietni <https://www.asus.com/lv/>.

**MX: Garantía y Soporte**

Esta Garantía aplica en el país de compra. Usted acepta que en esta garantía:

- Los procedimientos de servicio pueden variar en función del país.
- Algunos servicios y/o piezas de reemplazo pudieran no estar disponibles en todos los países.
- Algunos países pueden tener tarifas y restricciones que se apliquen en el momento de realizar el servicio, visite el sitio de soporte de ASUS en <https://www.asus.com/mx/support/> para ver más detalles.
- Si tiene alguna queja o necesidad de un centro de reparación local o el periodo de garantía del producto ASUS, por favor visite el sitio de Soporte de ASUS en <https://www.asus.com/mx/support/> para mayores detalles.

**Información de contacto ASUS**

Esta garantía está respaldada por:  
ASUSTeK Computer Inc.  
Centro de Atención ASUS +52 (55) 1946-3663

**NW: Informasjon om ASUS-garanti**

- ASUS tilbyr som produsent en frivillig kommersiell garanti.
- ASUS forbeholder seg retten til å tolke bestemmelsene i ASUS sin kommersielle garanti.
- ASUS sin kommersielle garanti gis uavhengig og i tillegg til den lovbestemte juridiske garantien, og verken påvirker eller begrenser rettighetene under den juridiske garantien på noen måte.

Du finner fullstendig informasjon om garanti på <https://www.asus.com/no/support/>.

**PG: Informações de Garantia ASUS**

- A ASUS oferece uma Garantia Comercial voluntária do fabricante.
- A ASUS reserva o direito de interpretar as disposições da Garantia Comercial da ASUS.
- Esta Garantia Comercial da ASUS é fornecida de forma independente além da Garantia Legal estatutária e não afeta nem limita de qualquer forma os direitos estabelecidos na Garantia Legal.

Para consultar todas as informações sobre a garantia, visite <https://www.asus.com/pt/support/>.

**PL: Informacje o gwarancji firmy ASUS**

- Firma ASUS oferuje dobrowolną gwarancję handlową producenta.
- Firma ASUS zastrzega sobie prawo do interpretacji warunków gwarancji handlowej firmy ASUS.
- Niniejsza gwarancja handlowa firmy ASUS jest udzielana niezależnie, jako dodatek do wymaganej ustawowo gwarancji prawnej i w żaden sposób nie wpływa na prawa przysługujące na mocy gwarancji prawnej ani ich nie ogranicza.

Wszelkie informacje na temat gwarancji można znaleźć na stronie <https://www.asus.com/pl/support/>.

**RO: Informații despre garanția ASUS**

- ASUS oferă o garanție comercială voluntară a producătorului.
- ASUS își rezervă dreptul de a interpreta prevederile garanției comerciale ASUS.
- Această garanție comercială ASUS este oferită independent și în plus față de garanția obligatorie legală și nu afectează sau limitează în niciun fel drepturile acordate conform garanției legale.

Pentru toate informațiile legate de garanție, vizitați <https://www.asus.com/ro/support/>

**S: Información de garantía de ASUS**

- ASUS ofrece una garantía comercial voluntaria del fabricante.
- ASUS se reserva el derecho de interpretar las disposiciones de esta garantía comercial de ASUS.
- Esta garantía comercial de ASUS se proporciona de forma independiente y adicional a la garantía estatutaria y de ninguna manera afecta a los derechos bajo la garantía legal ni los limita.

Para obtener toda la información sobre la garantía, visite <https://www.asus.com/ES/support/>.

**SB: Informacije o ASUS garanciji**

- ASUS nudi dobrowoljno proizvođačku komercijalnu garanciju.
- ASUS zadržava pravo da tumači odredbe svoje ASUS komercijalne garancije.
- Ova ASUS komercijalna garancija daje se nezavisno, kao dodatak zakonskoj pravnoj garanciji, i ni ka koji način ne utiče na i ne ograničava prava data pravnom garancijom.

Za sve informacije o garanciji, posetite <https://www.asus.com/support/>.

**SK: Informácie o záruke ASUS**

- ASUS ponúka dobrovoľnú obchodnú záruku výrobcu.
- ASUS si vyhradzuje právo interpretovať ustanovenia obchodnej záruky ASUS.
- Táto obchodná záruka ASUS je poskytnutá nezávisle a navyše k zákonnej záruke a v žiadnom prípade neovplyvňuje ani neobmedzuje tieto práva podľa tejto zákonnej záruky.

Všetky ďalšie informácie o záruke nájdete na <https://www.asus.com/sk/support/>

**SL: Informacije o garanciji ASUS**

- ASUS ponuja prostovoljno tržno garancijo proizvajalca.
- ASUS si pridržuje pravico do razlage določb tržne garancije družbe ASUS.
- Ta tržna garancija družbe ASUS je na voljo neodvisno in kot dodatek zakonsko predpisani pravni garanciji ter na noben način ne vpliva na pravice, ki jih zagotavlja pravna garancija, oziroma jih omejuje.

Vse informacije o garanciji najdete na spletnem mestu <https://www.asus.com/support/>.

**SW: ASUS garantiinformation**

- ASUS erbjuder en frivillig kommersiell tillverkningsgaranti.
- ASUS förbehåller sig rätten att tolka bestämmelserna i ASUS kommersiella garanti.
- Denna kommersiella garanti från ASUS tillhandahålls separat och som tillägg till den lagstadgade garantin, och påverkar eller begränsar på intet sätt rättigheterna under den lagstadgade garantin.

För all garantiinformation, besök <https://www.asus.com/se/support/>.

**TR: ASUS Garanti Bilgileri**

- ASUS, gönüllü olarak üretici Ticari Garantisini sunar.
- ASUS, ASUS Ticari Garantisinin hükümlerini yorumlama hakkını saklı tutar.
- Bu ASUS Ticari Garantisini, bağımsız olarak ve hukuki Yasal Garanti'ye ek olarak sağlanır ve hiçbir şekilde Yasal Garanti kapsamındaki hakları etkilemez veya sınırlamaz.

Tüm garanti bilgileri için lütfen <https://www.asus.com/tr/support/> adresini ziyaret edin.

**UA: Інформація про Гарантію ASUS**

- ASUS пропонує добровільну Комерційну Гарантію виробника.
- ASUS застерігає за собою право тлумачити положення Комерційної Гарантії ASUS.
- Цю Комерційну Гарантію надано незалежно і на додаток до обов'язкової Законної Гарантії, вона жодним чином не впливає на права за Законною Гарантією і не обмежує їх.

Всю інформацію про гарантію подано тут: <https://www.asus.com/ua/support/>.

Компанія ASUS не несе відповідальності за шкоду, заподіяну життю, здоров'ю чи майну користувача або інших осіб внаслідок використання несправного Виробу або такого Виробу, що не пройшов діагностику після закінчення терміну служби.

З метою перевірки технічного стану Виробу та визначення безпеки його подальшого використання після закінчення терміну служби користувачу необхідно припинити використання Виробу та передати його в авторизований сервісний центр компанії ASUS протягом одного місяця з моменту виявлення пошкодження та/або закінчення терміну служби Виробу.

**BP: Informações de garantia ASUS**

Esta garantía aplica-se ao período definido pela garantia legal (90 dias) mais o período de garantia comercial oferecido pela ASUS. Por exemplo: 12M significa 12 meses de garantia no total (3 meses de garantia legal mais 9 meses de garantia contratual), 24 meses significa 24 meses de garantia no total (3 meses de garantia legal mais 21 meses de garantia contratual) e 36 meses significa 36 meses de garantia no total (3 meses de garantia legal e 33 de garantia contratual) a contar da data da garantia declarada (Data de Início da Garantia).

Para todas as informações de garantia, visite <https://www.asus.com/br/support/>.

**VN: Thông tin đảm bảo của ASUS**

- ASUS cung cấp Bảo hành thương mại tự nguyện của nhà sản xuất.
- ASUS bảo lưu quyền giải thích các điều khoản của Bảo hành thương mại của ASUS.
- Bảo hành thương mại này của ASUS được cung cấp độc lập và ngoài Bảo đảm pháp lý theo luật định và không có cách nào ảnh hưởng đến hoặc giới hạn các quyền theo Bảo lãnh pháp lý. Để biết tất cả các thông tin bảo hành, vui lòng truy cập

<https://www.asus.com/vn/support>

**ID: Informasi Garansi ASUS**

Periode garansi untuk Mainboard adalah 0 bulan dan Mainboard Workstation adalah 72 bulan Masa ("Garansi") sejak tanggal produk pertama kali dibeli oleh pelanggan akhir ("Tanggal Pembelian"). \* Silakan kunjungi situs Dukungan ASUS di <https://www.asus.com/id/support/warranty-status-inquiry/> untuk detail lebih lanjut. Jika bukti pembelian tidak dapat diberikan, tanggal produksi yang dicatat oleh ASUS akan dianggap sebagai awal dari Masa Garansi. Silahkan pindai Kode QR di bagian bawah halaman terakhir untuk Kartu Garansi versi Web dalam format PDF untuk lebih informasi jelas mengenai jaminan garansi Produk ASUS. Layanan Call Center Nomor Telepon: 1500128 (Senin-Jumat 09.30-17.00, Sabtu 09.30-12.00)

**מידע על אחריות ASUS :HB**

- ASUS מציעה אחריות מסחרית של יצרן מרצון.
- ASUS שומרת לעצמה את הזכות לפרש את הוראות הערבות המסחרית של ASUS.
- אחריות מסחרית זו של ASUS ניתנת באופן עצמאי ובנוסף לערבות המשפטית הסטטוטורית ואינה משפיעה או מגבילה בשום אופן את הזכויות במסגרת הערבות המשפטית.

למידע אודות האחריות, אנו בקר ב  
<https://www.asus.com/support>

No.	Kota	Provinsi	Alamat	Jam Kerja
1	Jakarta Pusat	Jakarta	Ruko Mangga Dua Mall No. RM-22, Jl. Mangga Dua Raya No.1, RT.1/RW.12, Mangga Dua Sel., Kecamatan Sawah Besar, Kota Jakarta Pusat, Daerah Khusus Ibukota Jakarta 10730	Senin-Jumat 09.30-17.00, Sabtu 09.30-12.00
2	Surabaya	Jawa Timur	Jl. Klampis Jaya No. 39, Surabaya, Jawa Timur, Indonesia, 60117	Senin-Jumat 09.30-17.00, Sabtu 09.30-12.00
3	Denpasar	Bali	Jl. Teuku Umar Barat No.888D, Denpasar, Bali, Indonesia, 80117	Senin-Jumat 09.30-17.00, Sabtu 09.30-12.00



Warranty Card (Online)

## ASUS contact information

### **ASUSTeK COMPUTER INC.**

Address: 1F, No. 15, Lide Rd., Beitou Dist., Taipei City 112  
<https://qr.asus.com/ProductSafety>

### **ASUS COMPUTER INTERNATIONAL (America)**

Address: 48720 Kato Rd., Fremont, CA 94538, USA

### **ASUS COMPUTER GmbH (Germany and Austria)**

Address: Harkortstrasse 21-23, 40880 Ratingen, Germany

### **ASUSTeK (UK) LIMITED**

Address: 1st Floor, Sackville House, 143-149 Fenchurch Street, London, EC3M 6BL, England,  
United Kingdom

### **ASUS GLOBAL PTE. LTD.**

Address: 10 Changi Business Park Central 2 #02-01 Hansapoint Singapore 486030  
<https://qr.asus.com/ProductSafety>

## Service and support

Visit our multi-language website at <https://www.asus.com/support>.



## Product register

Log in and register your device for better product support.

