

**PRIME  
B850M-F  
WIFI /  
PRIME  
B850M-F**

**ASUS**

**Motherboard**

E26910  
First Edition  
August 2025

**Copyright © 2025 ASUSTeK COMPUTER INC. All Rights Reserved.**

No part of this manual, including the products and software described in it, may be reproduced, transmitted, transcribed, stored in a retrieval system, or translated into any language in any form or by any means, except documentation kept by the purchaser for backup purposes, without the express written permission of ASUSTeK COMPUTER INC. ("ASUS").

Product warranty or service will not be extended if: (1) the product is repaired, modified or altered, unless such repair, modification or alteration is authorized in writing by ASUS; or (2) the serial number of the product is defaced or missing.

ASUS PROVIDES THIS MANUAL "AS IS" WITHOUT WARRANTY OF ANY KIND, EITHER EXPRESS OR IMPLIED, INCLUDING BUT NOT LIMITED TO THE IMPLIED WARRANTIES OR CONDITIONS OF MERCHANTABILITY OR FITNESS FOR A PARTICULAR PURPOSE. IN NO EVENT SHALL ASUS, ITS DIRECTORS, OFFICERS, EMPLOYEES OR AGENTS BE LIABLE FOR ANY INDIRECT, SPECIAL, INCIDENTAL, OR CONSEQUENTIAL DAMAGES (INCLUDING DAMAGES FOR LOSS OF PROFITS, LOSS OF BUSINESS, LOSS OF USE OR DATA, INTERRUPTION OF BUSINESS AND THE LIKE), EVEN IF ASUS HAS BEEN ADVISED OF THE POSSIBILITY OF SUCH DAMAGES ARISING FROM ANY DEFECT OR ERROR IN THIS MANUAL OR PRODUCT.

SPECIFICATIONS AND INFORMATION CONTAINED IN THIS MANUAL ARE FURNISHED FOR INFORMATIONAL USE ONLY, AND ARE SUBJECT TO CHANGE AT ANY TIME WITHOUT NOTICE, AND SHOULD NOT BE CONSTRUED AS A COMMITMENT BY ASUS. ASUS ASSUMES NO RESPONSIBILITY OR LIABILITY FOR ANY ERRORS OR INACCURACIES THAT MAY APPEAR IN THIS MANUAL, INCLUDING THE PRODUCTS AND SOFTWARE DESCRIBED IN IT.

Products and corporate names appearing in this manual may or may not be registered trademarks or copyrights of their respective companies, and are used only for identification or explanation and to the owners' benefit, without intent to infringe.

# Contents

Safety information.....	4
About this guide.....	6
Package contents.....	8
PRIME B850M-F WIFI / PRIME B850M-F specifications summary.....	9

## Chapter 1: Product Introduction

1.1	Before you proceed .....	13
1.2	Motherboard layout .....	14
1.2.1	Layout contents .....	14
1.2.2	Rear I/O connection.....	21
1.2.3	LAN port LEDs .....	22
1.2.4	Audio I/O connections.....	22
1.3	CPU installation .....	23
1.4	DIMM installation .....	24
1.5	M.2 module installation .....	26
1.6	Wi-Fi moving antenna installation (only for PRIME B850M-F WIFI) .....	27
1.7	BIOS FlashBack™ .....	28

## Chapter 2: BIOS and RAID Support

2.1	Knowing UEFI BIOS.....	29
2.2	ASUS EZ Flash 3 .....	30
2.3	ASUS CrashFree BIOS 3 .....	31
2.4	RAID configurations .....	32

## Appendix

General notices.....	33
Notices for Wi-Fi model.....	36
Notices for non Wi-Fi model .....	44
Warranty.....	46
ASUS contact information .....	49
Service and support .....	49
Product register .....	49

## Safety information

### Electrical safety



- To prevent electrical shock hazard, disconnect the power cable from the electrical outlet before relocating the system.
- When adding or removing devices to or from the system, ensure that the power cables for the devices are unplugged before the signal cables are connected. If possible, disconnect all power cables from the existing system before you add a device.
- Before connecting or removing signal cables from the motherboard, ensure that all power cables are unplugged.
- Seek professional assistance before using an adapter or extension cord. These devices could interrupt the grounding circuit.
- Ensure that your power supply is set to the correct voltage in your area. If you are not sure about the voltage of the electrical outlet you are using, contact your local power company.
- If the power supply is broken, do not try to fix it by yourself. Contact a qualified service technician or your retailer.

### Operation safety

- Before installing the motherboard and adding devices on it, carefully read all the manuals that came with the package.
- Before using the product, ensure all cables are correctly connected and the power cables are not damaged. If you detect any damage, contact your dealer immediately.
- To avoid short circuits, keep paper clips, screws, and staples away from connectors, slots, sockets and circuitry.
- Avoid dust, humidity, and temperature extremes. Do not place the product in any area where it may become wet.
- Place the product on a stable surface.
- If you encounter technical problems with the product, contact a qualified service technician or your retailer.
- Your motherboard should only be used in environments with ambient temperatures between 10°C and 35°C.
- When removing motherboard components or installing other devices, be sure to handle with care. We recommend wearing gloves or other protective gear to prevent injuries to yourself.

## Button/Coin Batteries Safety Information

1. Remove and immediately recycle or dispose of used batteries according to local regulations and keep out of reach of children. Do not incinerate or dispose of batteries in household trash.
2. If ingested or inserted inside any part of the body, call a local poison control center for treatment information. Even used batteries may cause serious injury or death.
3. This product uses CR2032 type batteries with a nominal voltage of 3V.
4. Do not attempt to recharge non-rechargeable batteries.
5. Do not forcibly discharge, recharge, disassemble, heat above the battery manufacturer's specified temperature rating, or incinerate. Doing so may result in injury or chemical burns caused by venting, leakage, or explosion.
6. This product contains non-replaceable batteries.

 <b>WARNING</b>	
<ul style="list-style-type: none"><li>• <b>INGESTION HAZARD:</b> This product contains a button cell or coin battery.</li><li>• <b>DEATH</b> or serious injury can occur if ingested.</li><li>• A swallowed button cell or coin battery can cause <b>Internal Chemical Burns</b> in as little as <b>2 hours</b>.</li><li>• <b>KEEP</b> new and used batteries <b>OUT OF REACH of CHILDREN</b>.</li><li>• <b>Seek immediate medical attention</b> if a battery is suspected to be swallowed or inserted inside any part of the body.</li></ul>	

## About this guide

This user guide contains the information you need when installing and configuring the motherboard.

## How this guide is organized

This guide contains the following parts:

- **Chapter 1: Product Introduction**  
This chapter describes the features of the motherboard and includes descriptions for each part of the motherboard.
- **Chapter 2: BIOS and RAID Support**  
This chapter tells how to boot into the BIOS, upgrade BIOS using the EZ Flash Utility and support on RAID.

## Where to find more information

Refer to the following sources for additional information and for product and software updates.

1. **ASUS website**  
The ASUS website ([www.asus.com](http://www.asus.com)) provides updated information on ASUS hardware and software products.
2. **Optional documentation**  
Your product package may include optional documentation, such as warranty flyers, that may have been added by your dealer. These documents are not part of the standard package.
3. **Motherboard Installation Guide**  
Please visit <https://www.asus.com/support> for more information on the Motherboard Installation Guide.



#### 4. Driver and Utilities FAQ

Please visit <https://www.asus.com/support> for more information on downloading and installing drivers and utilities for your motherboard.



#### 5. RAID Configuration Guide

Please visit <https://www.asus.com/support> for more information on the RAID Configuration Guide.



#### 6. BIOS FlashBack™ Feature

Please visit <https://www.asus.com/support> for more information on the BIOS FlashBack™ Feature.



## Conventions used in this guide

To ensure that you perform certain tasks properly, take note of the following notes used throughout this user guide.

<b>CAUTION</b>	Information to prevent damage to the components and injuries to yourself when trying to complete a task.
<b>IMPORTANT</b>	Instructions that you <b>MUST</b> follow to complete a task.
<b>NOTE</b>	Tips and additional information to help you complete a task.

## Package contents

Check your motherboard package for the following items.

---

Motherboard	1 x PRIME B850M-F WIFI motherboard OR 1 x PRIME B850M-F motherboard
Cables	2 x SATA 6Gb/s cables
Miscellaneous	1 x ASUS Wi-Fi moving antennas <b>(only for PRIME B850M-F WIFI)</b> 1 x I/O shield 1 x M.2 anchor package
Documentation	1 x Quick start guide

---

**NOTE:**

- If any of the above items is damaged or missing, contact your retailer.
  - Items not listed in the Package contents list above are purchased separately and do not come bundled with your motherboard package.
-

## PRIME B850M-F WIFI / PRIME B850M-F specifications summary

CPU	<p>AMD Socket AM5 for AMD Ryzen™ 9000 &amp; 8000 &amp; 7000 Series Desktop Processors*</p> <p>Supports up to AMD 120W CPU</p> <p>* Refer to <a href="https://www.asus.com/support/download-center/">https://www.asus.com/support/download-center/</a> for CPU support list.</p>
Chipset	<p>AMD B850 Chipset</p>
Memory	<p>2 x DIMM slots, max. 128GB, DDR5</p> <p>Supports up to</p> <p>8200+MT/s(OC) with Ryzen™ 9000 Series Processors, 8400+MT/s(OC) with Ryzen™ 8000 Series Processors, 8000+MT/s(OC) with Ryzen™ 7000 Series Processors, ECC and Non-ECC, Un-buffered DIMM*</p> <p>Dual Channel Memory Architecture</p> <p>Supports AMD Extended Profiles for Overclocking (EXPO™)</p> <p>ASUS Enhanced Memory Profile (AEMP)</p> <p>* Supported memory types, data rate (speed), and number of DRAM modules vary depending on the CPU and memory configuration, for more information please refer to CPU/Memory Support list under the Support tab of product information site or visit <a href="https://www.asus.com/support/download-center/">https://www.asus.com/support/download-center/</a>. Adjustments will be made based on the specifications of mass-produced memory products available on the market.</p> <p>* Non-ECC, un-buffered DDR5 memory supports On-Die ECC function.</p>
Graphics	<p>1 x HDMI™ port**</p> <p>* Graphics specifications may vary between CPU types. Please refer to AMD CPU specifications.</p> <p>** Supports 4K@60Hz as specified in HDMI 2.1.</p>
Expansion Slots	<p><b>AMD Ryzen™ 9000 &amp; 7000 Series Desktop Processors*</b></p> <p>1 x PCIe 5.0 x16 slot (supports x16 mode)</p> <p><b>AMD Ryzen™ 8000 Series Desktop Processors</b></p> <p>1 x PCIe 4.0 x16 slot (supports x8/x4 mode)**</p> <p><b>AMD B850 Chipset</b></p> <p>1 x PCIe 4.0 x1 slot</p> <p>* Please check the PCIe bifurcation table on the support site (<a href="https://www.asus.com/support/FAQ/1037507/">https://www.asus.com/support/FAQ/1037507/</a>).</p> <p>** Specifications vary by CPU types.</p> <p>*** To ensure compatibility of the device installed, please refer to <a href="https://www.asus.com/support/download-center/">https://www.asus.com/support/download-center/</a> for the list of supported peripherals.</p>
Storage	<p><b>Total supports 2 x M.2 slots and 4 x SATA 6Gb/s ports</b></p> <p><b>AMD Ryzen™ 9000 &amp; 7000 Series Desktop Processors</b></p> <p>M.2_1 slot (Key M), type 2280 (supports PCIe 5.0 x4 mode)</p> <p>M.2_2 slot (Key M), type 2242/2260/2280 (supports PCIe 4.0 x4 mode)</p> <p><b>AMD Ryzen™ 8000 Series Desktop Processors</b></p> <p>M.2_1 slot (Key M), type 2280 (supports PCIe 4.0 x4 mode)</p> <p>M.2_2 slot (Key M), type 2242/2260/2280 (supports PCIe 4.0 x4/x2 mode)*</p> <p><b>AMD B850 Chipset</b></p> <p>4 x SATA 6Gb/s ports</p> <p>* Specifications vary by CPU types.</p>

(continued on the next page)

## PRIME B850M-F WIFI / PRIME B850M-F specifications summary

Storage	<p><b>AMD RAIDXpert2 Technology*</b></p> <p>Ryzen™ 9000 Series Processors: RAID 0/1/5/10</p> <p>Ryzen™ 8000 Series Processors: RAID 0/1</p> <p>Ryzen™ 7000 Series Processors: RAID 0/1/10</p> <p>* <b>Specifications vary by CPU types.</b></p>
Ethernet	<p>1 x Realtek 1Gb Ethernet</p> <p>ASUS LANGuard</p>
Wireless & Bluetooth®	<p><b>Wi-Fi 6 (only for PRIME B850M-F WIFI)</b></p> <p>1x1 Wi-Fi 6 (802.11 ax)</p> <p>Supports 2.4/5GHz frequency band</p> <p>Bluetooth® v5.3*</p> <p>* <b>The Bluetooth version may vary, please refer to the Wi-Fi module manufacturer's website for the latest specifications.</b></p>
USB	<p><b>Rear USB (Total 6 ports)</b></p> <p>2 x USB 5Gbps port (2 x Type-A)</p> <p>4 x USB 2.0 ports (4 x Type-A)</p> <p><b>Front USB (Total 7 ports)</b></p> <p>1 x USB 5Gbps connector (supports USB Type-C®)</p> <p>1 x USB 5Gbps header supports 2 additional USB 5Gbps ports</p> <p>2 x USB 2.0 headers support 4 additional USB 2.0 ports</p> <p>* <b>USB Type-C® power delivery output: max. 5V/3A.</b></p>
Audio	<p><b>Realtek 7.1 Surround Sound High Definition Audio CODEC*</b></p> <ul style="list-style-type: none"> <li>- Supports: Jack-detection, Multi-streaming, Front Panel Jack-retasking</li> <li>- Supports up to 24-Bit/192 kHz playback</li> </ul> <p><b>Audio Features</b></p> <ul style="list-style-type: none"> <li>- Audio Shielding</li> <li>- Premium audio capacitors</li> <li>- Dedicated audio PCB layers</li> </ul> <p>* <b>A chassis with an HD audio module in the front panel is required to support 7.1 Surround Sound audio output.</b></p>
Back Panel I/O Ports	<p>2 x USB 5Gbps ports (2 x Type-A)</p> <p>4 x USB 2.0 ports (4 x Type-A)</p> <p>1 x HDMI™ port</p> <p>1 x Wi-Fi module (<b>only for PRIME B850M-F WIFI</b>)</p> <p>1 x Realtek 1Gb Ethernet port</p> <p>3 x Audio jacks</p> <p>1 x BIOS FlashBack™ button</p>
Internal I/O connectors	<p><b>Fan and Cooling Related</b></p> <p>1 x 4-pin CPU Fan header</p> <p>2 x 4-pin Chassis Fan headers</p> <p><b>Power Related</b></p> <p>1 x 24-pin Main Power connector</p> <p>1 x 8-pin +12V CPU Power connector</p>

(continued on the next page)

## PRIME B850M-F WIFI / PRIME B850M-F specifications summary

<p><b>Internal I/O connectors</b></p>	<p><b>Storage Related</b>                  2 x M.2 slots (Key M)                  4 x SATA 6Gb/s ports</p> <p><b>USB</b>                  1 x USB 5Gbps connector (supports USB Type-C®)                  1 x USB 5Gbps header supports 2 additional USB 5Gbps ports                  2 x USB 2.0 headers support 4 additional USB 2.0 ports</p> <p><b>Miscellaneous</b>                  3 x Addressable RGB Gen 2 headers                  1 x Clear CMOS header                  1 x COM Port header                  1 x Front Panel Audio header (F_AUDIO)                  1 x S/PDIF Out header                  1 x SPI TPM header (14-1pin)                  1 x 10-1 pin Front Panel System header</p>
<p><b>Special Features</b></p>	<p><b>ASUS 5X PROTECTION</b>                  - DIGI+ VRM                  - LANGuard                  - Overvoltage protection                  - SafeSlot                  - Stainless-steel back I/O</p> <p><b>ASUS Q-Design</b>                  - Q-Dashboard                  - Q-DIMM                  - Q-LED Core                  - Q-Slot</p> <p><b>ASUS EZ DIY</b>                  - BIOS FlashBack™ button                  - BIOS FlashBack™ LED                  - SafeSlot</p> <p><b>Aura Sync</b>                  - Addressable RGB Gen 2 headers</p>

*(continued on the next page)*

## PRIME B850M-F WIFI / PRIME B850M-F specifications summary

Software Features	<p><b>ASUS Exclusive Software</b></p> <p>Armoury Crate</p> <ul style="list-style-type: none"> <li>- Aura Creator</li> <li>- Aura Sync</li> <li>- Fan Xpert 2+</li> </ul> <p>ASUS AI Advisor</p> <p>ASUS DriverHub</p> <p>ASUS GlideX (<b>only for PRIME B850M-F WIFI</b>)</p> <ul style="list-style-type: none"> <li>- ASUS CPU-Z</li> </ul> <p>TurboV Core</p> <p>Adobe Creative Cloud (Free Trial)**</p> <p>Norton 360 Deluxe (60 Days Free Trial)</p> <p>WinRAR (40 Days Free Trial)</p> <p><b>UEFI BIOS</b></p> <p>AI Cache Boost</p> <p>ASUS EZ DIY</p> <ul style="list-style-type: none"> <li>- ASUS CrashFree BIOS 3</li> <li>- ASUS EZ Flash 3</li> <li>- ASUS UEFI BIOS EZ Mode</li> <li>- ASUS MyHotkey</li> </ul> <p>* For more software features, please visit the asus support site or refer to <a href="http://www.asus.com/support">www.asus.com/support</a> for additional information.</p> <p>** For detailed information on the supported models and restricted regions for this redemption offer, please refer to <a href="https://www.asus.com/content/asus-offers-adobe-creative-cloud/">https://www.asus.com/content/asus-offers-adobe-creative-cloud/</a>.</p>
BIOS	256 Mb Flash ROM, UEFI AMI BIOS
BIOS CAP Filename	<b>PRIME B850M-F WIFI:</b> A5729.CAP <b>PRIME B850M-F:</b> A5730.CAP
Manageability	WOL by PME, PXE
Operating System	Windows 11 Windows 10 64-bit
Form Factor	micro-ATX Form Factor 8.9 inch x 8.75 inch (22.6 cm x 22.2cm)

**NOTE:** Specifications are subject to change without notice. Please refer to the ASUS website for the latest specifications.

# Product Introduction

## 1.1 Before you proceed

Take note of the following precautions before you install motherboard components or change any motherboard settings.

---

**CAUTION!**

- Unplug the power cord from the wall socket before touching any component.
- Before handling components, use a grounded wrist strap or touch a safely grounded object or a metal object, such as the power supply case, to avoid damaging them due to static electricity.
- Hold components by the edges to avoid touching the ICs on them.
- Whenever you uninstall any component, place it on a grounded antistatic pad or in the bag that came with the component.
- Before you install or remove any component, ensure that the power supply is switched off or the power cord is detached from the power supply. Failure to do so may cause severe damage to the motherboard, peripherals, or components.

---

**NOTE:**

- The pin definitions in this chapter are for reference only. The pin names depend on the location of the header/jumper/connector.
  - The illustrations for this chapter are for reference only. The WiFi module is only available on selected models.
-

# 1.2 Motherboard layout

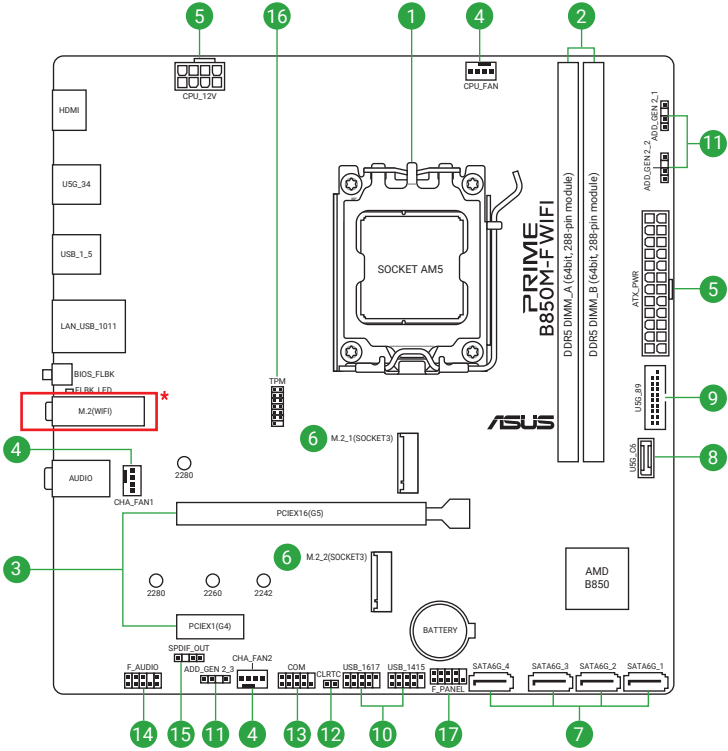

\* The Wi-Fi module is only available on selected models.

## 1.2.1 Layout contents

### 1. CPU socket

The motherboard comes with a Socket AM5 designed for AMD Ryzen™ 9000 & 8000 & 7000 Series Desktop Processors.

**NOTE:** For more details, refer to **CPU installation**.

### 2. DIMM slots

The motherboard comes with Dual Inline Memory Modules (DIMM) slots designed for DDR5 (Double Data Rate 5) memory modules.

**NOTE:** For more details, refer to **DIMM installation**.

### 3. Expansion slots

This motherboard supports one PCIe x16 graphics card and one PCIe x1 network cards, SCSI cards and other cards that comply with the PCI Express specification.

Slot Description	PCIe bifurcation settings in PCIe x16 slots with different Ryzen™ CPUs
	AMD Ryzen™ 9000 & 7000 Series Desktop Processors
PCIEX16(G5)	4(x4+x4+x4+x4)

#### NOTE:

- Hyper M.2 X16 series card sold separately.
- Additional PCIe bifurcation and M.2 settings for RAID function are also supported when a Hyper M.2 X16 series card is installed.
- For more details on the PCIe bifurcation, you may visit the support site at <https://www.asus.com/support/FAQ/1037507/>.
- Adjust the PCIe bifurcation under BIOS settings.
- Enable the Hyper M.2 X16 series card under BIOS settings.
- Creating RAID with the Hyper M.2 X16 series card is limited to a maximum of 10 SSDs.

### 4. Fan headers

The Fan headers allow you to connect fans to cool the system.

CPU\_FAN

CHA\_FAN1

CHA\_FAN2



#### CAUTION!

- DO NOT forget to connect the fan cables to the fan headers. Insufficient air flow inside the system may damage the motherboard components. These are not jumpers! Do not place jumper caps on the fan headers!
- Ensure the cable is fully inserted into the header.

Header	Max. Current	Max. Power	Default Speed	Shared Control
CPU_FAN	1A	12W	Q-Fan Controlled	-
CHA_FAN1	1A	12W	Q-Fan Controlled	-
CHA_FAN2	1A	12W	Q-Fan Controlled	-

## 5. Power connectors

These Power connectors allow you to connect your motherboard to a power supply. The power supply plugs are designed to fit in only one orientation. Find the proper orientation and push down firmly until the power supply plugs are fully inserted.

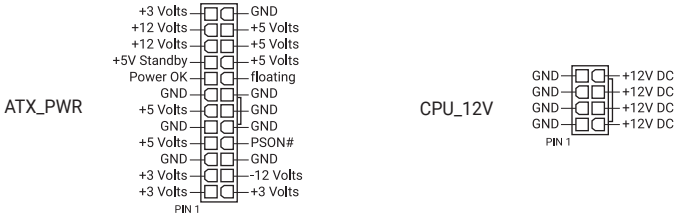

**CAUTION!** Ensure to connect the 8-pin power plug.

### NOTE:

- We recommend that you use a PSU with a higher power output when configuring a system with more power-consuming devices. The system may become unstable or may not boot up if the power is inadequate.
- PSU input: AC 100~240V, 6A/3A, 50/60Hz.

## 6. M.2 slot

The M.2 slot allows you to install M.2 devices such as M.2 SSD modules.

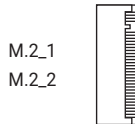

### NOTE:

- **For AMD Ryzen™ 9000 & 7000 Series Desktop Processors**
  - M.2\_1 slot (Key M), type 2280 (supports PCIe 5.0 x4 mode)
  - M.2\_2 slot (Key M), type 2242/2260/2280 (supports PCIe 4.0 x4 mode)
- **For AMD Ryzen™ 8000 Series Desktop Processors**
  - M.2\_1 slot (Key M), type 2280 (supports PCIe 4.0 x4 mode)
  - M.2\_2 slot (Key M), type 2242/2260/2280 (supports PCIe 4.0 x4/x2 mode)\*
- **AMD RAIDXpert2 Technology\***
  - Ryzen™ 9000 Series Processors: RAID 0/1/5/10
  - Ryzen™ 8000 Series Processors: RAID 0/1
  - Ryzen™ 7000 Series Processors: RAID 0/1/10

\* Specifications vary by CPU types.

## 7. SATA 6Gb/s port

The SATA 6Gb/s port allows you to connect SATA devices such as optical disc drives and hard disk drives via a SATA cable.



### NOTE:

- If you installed SATA storage devices to the **SATA6G\_1-4** ports, you can create RAID configurations through the onboard AMD B850 chipset.
- To install a SATA device, please refer to the **Motherboard Installation Guide** on the ASUS support site.
- Before creating a RAID set, refer to the **RAID Configuration Guide**. You can download the **RAID Configuration Guide** from the ASUS support site.

## 8. USB 5Gbps Type-C® Front Panel connector

The USB 5Gbps Type-C® connector allows you to connect a USB 5Gbps Type-C® module for an additional USB 5Gbps Type-C® port. The USB 5Gbps Type-C® connector provides data transfer speeds of up to 5 Gb/s.

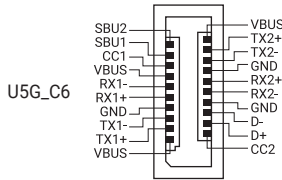

## 9. USB 5Gbps header

The USB 5Gbps header allows you to connect a USB 5Gbps module for additional USB 5Gbps ports. The USB 5Gbps header provides data transfer speeds of up to 5 Gb/s.

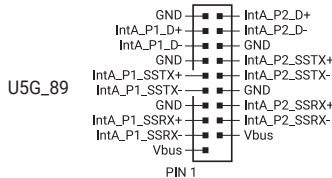

## 10. USB 2.0 header

The USB 2.0 header allows you to connect a USB module for additional USB 2.0 ports. The USB 2.0 header provides data transfer speeds of up to 480 Mb/s.

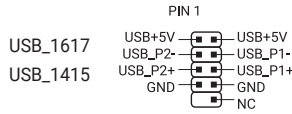

---

**CAUTION!** DO NOT connect a 1394 cable to the USB connectors. Doing so will damage the motherboard!

---

## 11. Addressable RGB Gen 2 header

The Addressable RGB Gen 2 header allows you to connect individually addressable RGB (ARGB) WS2812B LED strips or WS2812B based LED strips.

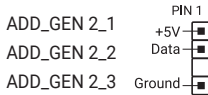

---

**CAUTION!** Before you install or remove any component, ensure that the power supply is switched off or the power cord is detached from the power supply. Failure to do so may cause severe damage to the motherboard, peripherals, or components.

---

### NOTE:

- The Addressable RGB Gen 2 header supports addressable RGB LED strips (5V/Data/Ground), with a maximum power rating of 3A (5V). Additionally, the addressable header on this board can support up to 120 LEDs per header in Gen1 mode, or a combined maximum of 500 LEDs in Gen2 mode.
  - Actual lighting and color will vary with LED strip.
  - If your LED strip does not light up, check if the addressable RGB LED strip is connected in the correct orientation, and the 5V connector is aligned with the 5V header on the motherboard.
  - The addressable RGB LED strip will only light up when the system is powered on.
-

## 12. Clear CMOS header

The Clear CMOS header allows you to clear the Real Time Clock (RTC) RAM in the CMOS, which contains the date, time, system passwords, and system setup parameters.

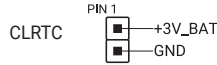

To erase the RTC RAM:

1. Turn OFF the computer and unplug the power cord.
2. Short-circuit pin 1-2 with a metal object or jumper cap for about 5-10 seconds.
3. Plug the power cord and turn ON the computer.
4. Hold down the <Del> key during the boot process and enter BIOS setup to re-enter data.

---

**CAUTION!** DO NOT short-circuit the pins except when clearing the RTC RAM. Short-circuiting or placing a jumper cap will cause system boot failure!

---

## 13. COM Port header

The COM (Serial) Port connector allows you to connect a COM port module. Connect the COM port module cable to this connector, then install the module to a slot opening on the system chassis.

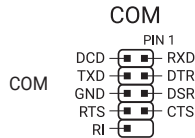

## 14. Front Panel Audio header

The Front Panel Audio header is for a chassis-mounted front panel audio I/O module that supports HD Audio. Connect one end of the front panel audio I/O module cable to this header.

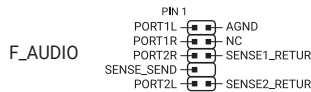

## 15. S/PDIF Out header

The S/PDIF Out header allows you to connect the Sony/Philips Digital Interface (S/PDIF) Out module.



## 16. TPM header

The TPM header allows you to connect a TPM module, which securely stores keys, digital certificates, passwords, and data. A TPM system also helps enhance network security, protect digital identities, and ensures platform integrity.

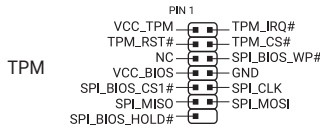

## 17. Front Panel System header

The Front Panel System header supports several chassis-mounted functions.

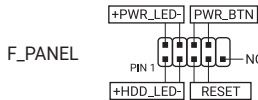

- **System Power LED header (+PWR\_LED-)**

The 2-pin header allows you to connect the System Power LED. The System Power LED lights up when the system is connected to a power source, or when you turn on the system power, and blinks when the system is in sleep mode.

- **Storage Device Activity LED header (+HDD\_LED-)**

The 2-pin header allows you to connect the Storage Device Activity LED. The Storage Device Activity LED lights up or blinks when data is read from or written to the storage device or storage device add-on card.

- **Power Button/Soft-off Button header (PWR\_BTN)**

The 3-1 pin header allows you to connect the system power button. Press the power button to power up the system, or put the system into sleep or soft-off mode (depending on the operating system settings).

- **Reset button header (RESET)**

The 2-pin header allows you to connect the chassis-mounted reset button. Press the reset button to reboot the system.

## 1.2.2 Rear I/O connection

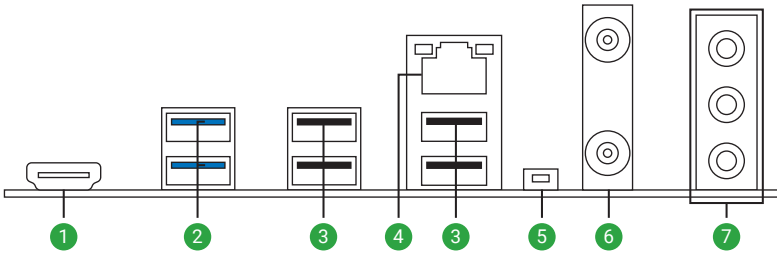

### Rear panel connectors

- |    |   |
|----|---|
| 1. | HDMI™ port  |
| 2. | USB 5Gbps ports 3 and 4                             |
| 3. | USB 2.0 ports 1, 5, 10 and 11                       |
| 4. | Realtek 1Gb Ethernet port*                          |
| 5. | BIOS FlashBack™ button                              |
| 6. | Wi-Fi module ( <b>only for PRIME B850M-F WIFI</b> ) |
| 7. | Audio jacks**                                       |

\* and \*\*: Refer to the tables under LAN port LEDs, and Audio I/O connections sections.

**NOTE:** We strongly recommend that you connect your devices to ports with matching data transfer rate. For example connecting your USB 5Gbps devices to USB 5Gbps ports for faster and better performance for your devices.

### 1.2.3 LAN port LEDs

Realtek 1Gb Ethernet port LED indications

Activity Link LED		Speed LED	
Status	Description	Status	Description
OFF	No link	OFF	10 Mbps connection
ORANGE	Linked	ORANGE	100 Mbps connection
BLINKING	Data activity	GREEN	1 Gbps connection

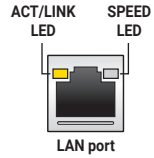

### 1.2.4 Audio I/O connections

Audio 2, 4, 5.1 or 7.1-channel configuration

Port	2-channel	4-channel	5.1-channel	7.1-channel
<b>Rear panel</b>				
LINE IN	-	Rear Speaker Out	Rear Speaker Out	Rear Speaker Out
LINE OUT	Front Speaker Out	Front Speaker Out	Front Speaker Out	Front Speaker Out
MIC IN	-	-	Center/ Subwoofer	Center/ Subwoofer
<b>Front panel</b>				
HEADPHONE (Lime)	-	-	-	Side Speaker Out
MIC IN (Pink)	-	-	-	-

## 1.3 CPU installation

### CAUTION!

- The AM5 socket has a different pinout design. Ensure that you use a CPU designed for the AM5 socket.
- The CPU fits in only one correct orientation. DO NOT force the CPU into the socket to prevent bending the connectors on the socket and damaging the CPU.
- Ensure that all power cables are unplugged before installing the CPU.
- Upon purchase of the motherboard, ensure that the PnP cap is on the socket and the socket contacts are not bent. Contact your retailer immediately if the PnP cap is missing, or if you see any damage to the PnP cap/socket contacts/motherboard components. ASUS will shoulder the cost of repair only if the damage is shipment/transit-related.
- Keep the cap after installing the motherboard. ASUS will process Return Merchandise Authorization (RMA) requests only if the motherboard comes with the cap on the AM5 socket.
- The product warranty does not cover damage to the socket contacts resulting from incorrect CPU installation/removal, or misplacement/loss/incorrect removal of the PnP cap.

**IMPORTANT!** Install a heatsink or AIO cooler after installing the CPU. Please refer to the **Motherboard Installation Guide** on the ASUS support site, or to the user manual of the heatsink/AIO cooler for steps on installing the heatsink/AIO cooler.

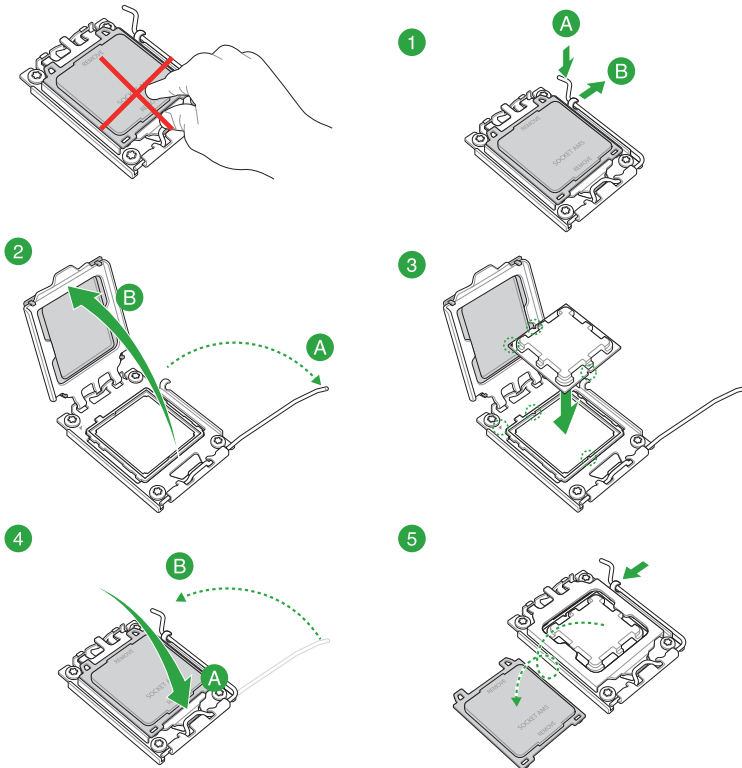

## 1.4 DIMM installation

The figure illustrates the location of the DDR5 DIMM sockets.



---

**CAUTION!** A DDR5 memory module is notched differently from a DDR, DDR2, DDR3, or DDR4 module. DO NOT install a DDR, DDR2, DDR3, or DDR4 memory module to the DDR5 slot.

---

### Recommended memory configurations

Memory configurations	DIMM	
	A	B
1 DIMM	✓	
2 DIMMs	✓	✓

You may install ECC and Non-ECC DDR5 DIMMs into the DIMM sockets.

---

**NOTE:**

- The default memory operation frequency is dependent on its Serial Presence Detect (SPD), which is the standard way of accessing information from a memory module. Under the default state, some memory modules for overclocking may operate at a lower frequency than the vendor-marked value.
  - For system stability, use a more efficient memory cooling system to support a full memory load or overclocking condition.
  - Always install the DIMMs with the same CAS Latency. For an optimum compatibility, we recommend that you install memory modules of the same version or data code (D/C) from the same vendor. Check with the vendor to get the correct memory modules.
  - Visit the ASUS website for the latest QVL.
-

# Installing a DIMM

1

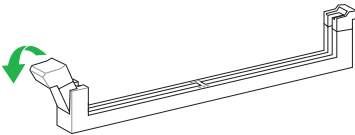

2

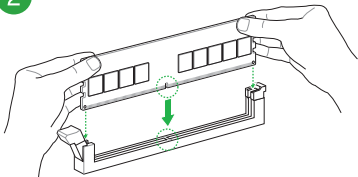

3

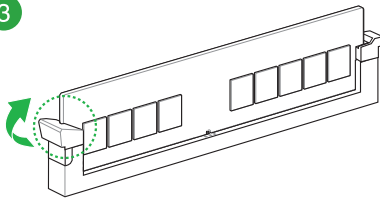

# Removing a DIMM

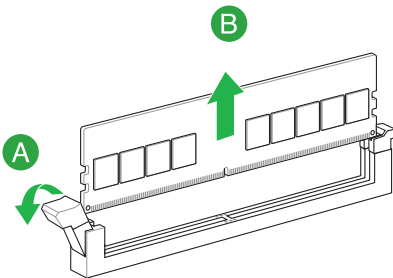

# 1.5 M.2 module installation

**NOTE:**

- The illustration is for reference only. The motherboard layout may vary with models, but the M.2 module installation procedure is the same.
- Supported M.2 type varies per motherboard.

The M.2 Anchor is a tool-less design to easily fasten and secure your M.2 SSD card to your motherboard without using extra tools.

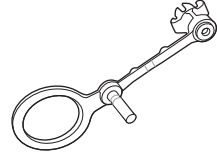

**To install the M.2 SSD card using the M.2 Anchor:**

1. Locate the M.2 mounting hole on your motherboard and firmly insert the M.2 Anchor into the hole.
2. Insert the M.2 SSD card into the M.2 slot. The notch at the end of the M.2 SSD card shall align with the rod of the M.2 Anchor.
3. Firmly insert the pin on the M.2 Anchor into the hole on itself.

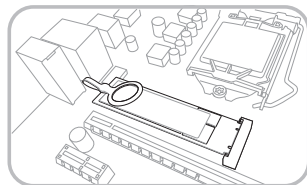
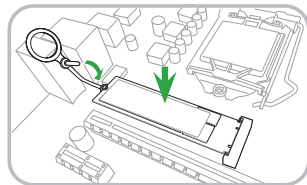
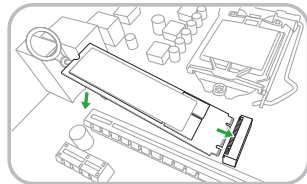
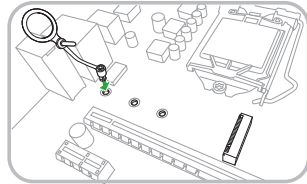

## 1.6 Wi-Fi moving antenna installation (only for PRIME B850M-F WIFI)

### Installing the ASUS Wi-Fi moving antenna

Connect the bundled ASUS Wi-Fi moving antenna connector to the Wi-Fi ports at the back of the chassis.

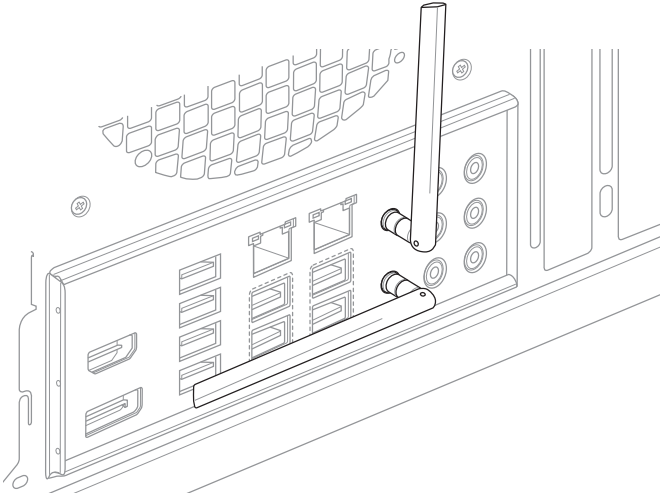

---

#### **IMPORTANT!**

- Ensure that the ASUS Wi-Fi moving antenna is securely installed to the Wi-Fi ports.
  - Ensure that the antenna is at least 20 cm away from all persons.
- 

#### **NOTE:**

- Install the two antennas at a 90-degree angle to each other.
  - The illustration above is for reference only. The I/O port layout may vary with models, but the Wi-Fi moving antenna installation procedure is the same for all models.
-

## 1.7 BIOS FlashBack™

**NOTE:** The illustrations in this section are for reference only. The WiFi module is only available on selected models.

BIOS FlashBack™ allows you to easily update the BIOS without entering the existing BIOS or operating system.

### To use BIOS FlashBack™:

1. Visit <https://www.asus.com/support/> and download the latest BIOS version for this motherboard.
2. Launch the **BIOSRenamer.exe** application to automatically rename the file or manually rename the file to the BIOS CAP filename specified in the **Specifications summary** section, then copy it to your USB storage device.

**NOTE:** The **BIOSRenamer.exe** application is zipped together with your BIOS file when you download a BIOS file for a BIOS FlashBack™ compatible motherboard.

3. Plug the 24-pin power connector to the motherboard and turn on the power supply (no need to power on the system). Insert the USB storage device to the USB port with BIOS FlashBack™ function.
4. Press the BIOS FlashBack™ button for three (3) seconds until the BIOS FlashBack™ LED blinks three times, indicating that the BIOS FlashBack™ function is enabled.

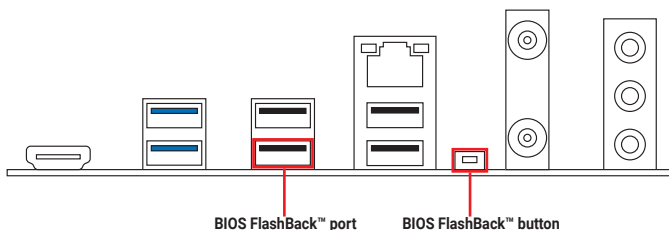

5. Wait until the light goes out, indicating that the BIOS updating process is completed.

**NOTE:** For more BIOS update utilities in BIOS setup, refer to **BIOS and RAID Support** section.

### CAUTION!

- Do not unplug portable disk, power system, press the Clear CMOS button, or short the CLRTC header while BIOS update is ongoing, otherwise update will be interrupted. In case of interruption, please follow the steps again.
- If the light flashes for five seconds and turns into a solid light, this means that the BIOS FlashBack™ is not operating properly. This may be caused by improper installation of the USB storage device and filename/file format error. If this scenario happens, please restart the system to turn off the light.
- Updating BIOS may have risks. If the BIOS program is damaged during the process and results to the system's failure to boot up, please contact your local ASUS Service Center.

# BIOS and RAID Support

---

**NOTE:** For more details on BIOS and RAID configurations, please refer to Manual & Document under the Support tab of the product information site, or visit <https://www.asus.com/support>.

---

## 2.1 Knowing UEFI BIOS

BIOS (Basic Input and Output System) stores system hardware settings such as storage device configuration, overclocking settings, advanced power management, and boot device configuration that are needed for system startup in the motherboard CMOS. In normal circumstances, the default BIOS settings apply to most conditions to ensure optimal performance. **DO NOT change the default BIOS settings** except in the following circumstances:

- An error message appears on the screen during the system bootstrap and requests you to run the BIOS Setup.
- You have installed a new system component that requires further BIOS settings or update.

---

**CAUTION!** Inappropriate BIOS settings may result to instability or boot failure. **We strongly recommend that you change the BIOS settings only with the help of a trained service personnel.**

---

**NOTE:** BIOS settings and options may vary due to different BIOS release versions. Please refer to the latest BIOS version for settings and options.

---

### Entering BIOS at startup

To enter BIOS Setup at startup, press <Delete> or <F2> during the Power-On Self Test (POST). If you do not press <Delete> or <F2>, POST continues with its routines.

---

#### **IMPORTANT!**

- If the system becomes unstable after changing any BIOS setting, load the default settings to ensure system compatibility and stability. Select the **Load Optimized Defaults** item under the **Exit** menu or press the <F5> hotkey.
  - If the system fails to boot after changing any BIOS setting, try to clear the CMOS and reset the motherboard to the default value.
  - The BIOS setup program does not support Bluetooth devices.
- 

### BIOS menu screen

The BIOS Setup program can be used under two modes: **EZ Mode** and **Advanced Mode**. You can change modes from **Setup Mode** in **Boot menu** or by pressing the <F7> hotkey.

## 2.2 ASUS EZ Flash 3

The ASUS EZ Flash 3 feature allows you to update the BIOS without using an OS-based utility.

---

**IMPORTANT!** Ensure to load the BIOS default settings to ensure system compatibility and stability. Select the **Load Optimized Defaults** item under the **Exit** menu or press the <F5> hotkey.

---

### To update the BIOS:

---

**CAUTION!**

- This function can support devices such as a USB flash disk with FAT 32/16 format and single partition only.
  - DO NOT shut down or reset the system while updating the BIOS to prevent system boot failure!
- 

1. Insert the USB flash disk that contains the latest BIOS file to the USB port.
2. Enter the Advanced Mode of the BIOS setup program. Go to the **Tool** menu to select **ASUS EZ Flash 3 Utility** and press <Enter>.
3. Press the Left arrow key to switch to the **Drive** field.
4. Press the Up/Down arrow keys to find the USB flash disk that contains the latest BIOS, and then press <Enter>.
5. Press the Right arrow key to switch to the **Folder** field.
6. Press the Up/Down arrow keys to find the BIOS file, and then press <Enter> to perform the BIOS update process. Reboot the system when the update process is done.

## 2.3 ASUS CrashFree BIOS 3

The ASUS CrashFree BIOS 3 utility is an auto recovery tool that allows you to restore the BIOS file when it fails or gets corrupted during the updating process. You can restore a corrupted BIOS file using a USB flash drive that contains the BIOS file.

### Recovering the BIOS

1. Download the latest BIOS version for this motherboard from <https://www.asus.com/support/>.
2. Rename the file using one of the following methods:
  - Launch the **BIOSRenamer.exe** application to automatically rename the file.
  - Manually rename the file to the BIOS CAP filename specified in the **Specifications summary** section.
  - Manually rename the file to **ASUS.CAP**.
3. Copy the renamed file to your USB storage device.
4. Insert the USB flash drive containing the BIOS file to a USB port.
5. Turn on the system.
6. The utility automatically checks the devices for the BIOS file. When found, the utility reads the BIOS file and enters ASUS EZ Flash 3 automatically.
7. The system requires you to enter BIOS Setup to recover the BIOS setting. To ensure system compatibility and stability, we recommend that you press the <F5> hotkey to load default BIOS values.

---

**CAUTION!** DO NOT shut down or reset the system while updating the BIOS! Doing so may cause system boot failure!

---

## 2.4 RAID configurations

The motherboard supports RAID configurations.

### RAID definitions

**Volume** provides the ability to link-together storage from one or several disks, regardless of the size of the space on those disks. This configuration is useful in scavenging space on disks unused by other disks in the array. This configuration does not provide performance benefits or data redundancy, disk failure will result in data loss.

**RAIDABLE** arrays (also known as RAID Ready) are a special type of Volume (JBOD) that allows the user to add more storage space or create a redundant array after a system is installed.

---

**NOTE:** The ability to create RAIDABLE arrays may vary per system.

---

**RAID 0 (Data striping)** optimizes two identical hard disk drives to read and write data in parallel, interleaved stacks. Two hard disks perform the same work as a single drive but at a sustained data transfer rate, double that of a single disk alone, thus improving data access and storage. Use of two new identical hard disk drives is required for this setup.

**RAID 1 (Data mirroring)** copies and maintains an identical image of data from one drive to a second drive. If one drive fails, the disk array management software directs all applications to the surviving drive as it contains a complete copy of the data in the other drive. This RAID configuration provides data protection and increases fault tolerance to the entire system. Use two new drives or use an existing drive and a new drive for this setup. The new drive must be of the same size or larger than the existing drive.

**RAID 5** stripes both data and parity information across three or more hard disk drives. Among the advantages of RAID 5 configuration include better HDD performance, fault tolerance, and higher storage capacity. The RAID 5 configuration is best suited for transaction processing, relational database applications, enterprise resource planning, and other business systems. Use a minimum of three identical hard disk drives for this setup.

**RAID 10** is data striping and data mirroring combined without parity (redundancy data) having to be calculated and written. With the RAID 10 configuration you get all the benefits of both RAID 0 and RAID 1 configurations. Use four new hard disk drives or use an existing drive and three new drives for this setup.

# Appendix

## General notices

### FCC Compliance Information

Responsible Party: Asus Computer International

Address: 48720 Kato Rd., Fremont, CA 94538, USA

Phone / Fax No: (510)739-3777 / (510)608-4555

This device complies with part 15 of the FCC Rules. Operation is subject to the following two conditions: (1) This device may not cause harmful interference, and (2) this device must accept any interference received, including interference that may cause undesired operation.

This equipment has been tested and found to comply with the limits for a Class B digital device, pursuant to part 15 of the FCC Rules. These limits are designed to provide reasonable protection against harmful interference in a residential installation. This equipment generates, uses and can radiate radio frequency energy and, if not installed and used in accordance with the instructions, may cause harmful interference to radio communications. However, there is no guarantee that interference will not occur in a particular installation. If this equipment does cause harmful interference to radio or television reception, which can be determined by turning the equipment off and on, the user is encouraged to try to correct the interference by one or more of the following measures:

- Reorient or relocate the receiving antenna.
- Increase the separation between the equipment and receiver.
- Connect the equipment into an outlet on a circuit different from that to which the receiver is connected.
- Consult the dealer or an experienced radio/TV technician for help.

### HDMI Trademark Notice

The terms HDMI, HDMI High-Definition Multimedia Interface, HDMI trade dress and the HDMI Logos are trademarks or registered trademarks of HDMI Licensing Administrator, Inc.



### 安全上のご注意

付属品は当該専用品です。他の機器には使用しないでください。機器の破損もしくは、火災や感電の原因となることがあります。

### インターネット回線への接続に関するご注意

本製品は電気通信事業者（移動通信会社、固定通信会社、インターネットプロバイダ等）の通信回線（公衆無線LANを含む）に直接接続することができません。本製品をインターネットに接続する場合は、必ずルーター等を経由し接続してください。

## Australia statement notice

From 1 January 2012 updated warranties apply to all ASUS products, consistent with the Australian Consumer Law. For the latest product warranty details please visit <https://www.asus.com/support/>. Our goods come with guarantees that cannot be excluded under the Australian Consumer Law. You are entitled to a replacement or refund for a major failure and compensation for any other reasonably foreseeable loss or damage. You are also entitled to have the goods repaired or replaced if the goods fail to be of acceptable quality and the failure does not amount to a major failure.

If you require assistance please call ASUS Customer Service 1300 2787 88 or visit us at <https://www.asus.com/support/>.

## Declaration of compliance for product environmental regulation

ASUS follows the green design concept to design and manufacture our products, and makes sure that each stage of the product life cycle of ASUS product is in line with global environmental regulations. In addition, ASUS disclose the relevant information based on regulation requirements.

Please refer to <https://esg.asus.com/Compliance.htm> for information disclosure based on regulation requirements ASUS is complied with:

### EU REACH and Article 33

Complying with the REACH (Registration, Evaluation, Authorisation, and Restriction of Chemicals) regulatory framework, we published the chemical substances in our products at ASUS REACH website at <https://esg.asus.com/Compliance.htm>.

### EU RoHS

This product complies with the EU RoHS Directive. For more details, see <https://esg.asus.com/Compliance.htm>

### India RoHS

This product complies with the "India E-Waste (Management) Rules, 2016" and prohibits use of lead, mercury, hexavalent chromium, polybrominated biphenyls (PBBs) and polybrominated diphenyl ethers (PBDEs) in concentrations exceeding 0.1% by weight in homogenous materials and 0.01% by weight in homogenous materials for cadmium, except for the exemptions listed in Schedule II of the Rule.

### Vietnam RoHS

ASUS products sold in Vietnam, on or after September 23, 2011, meet the requirements of the Vietnam Circular 30/2011/TT-BCT.

Các sản phẩm ASUS bán tại Việt Nam, vào ngày 23 tháng 9 năm 2011 trở về sau, đều phải đáp ứng các yêu cầu của Thông tư 30/2011/TT-BCT của Việt Nam.

### Türkiye RoHS

AEEE Yönetmeliğine Uygundur

### ASUS Recycling/Takeback Services

ASUS recycling and takeback programs come from our commitment to the highest standards for protecting our environment. We believe in providing solutions for you to be able to responsibly recycle our products, batteries, other components as well as the packaging materials. Please go to <https://esg.asus.com/en/Takeback.htm> for detailed recycling information in different regions.



The Waste Electrical and Electronic Equipment (WEEE) Directive (Directive 2012/19/EU) is a European Union law that aims to reduce the environmental impact of electrical and electronic equipment. It mandates producers to take responsibility for the end-of-life management of their products, promoting collection, treatment, and recycling to minimize waste and encourage resource recovery.

Do not throw your electrical and electronic equipment in municipal waste.

The symbol of the crossed-out wheeled bin on the product or packaging indicates that this product (including any batteries it contains) must not be disposed of with your household waste.

To prevent potential harm to the environment and human health, a collection framework should be used to return, recycle, and recover waste electrical and electronic equipment (WEEE), and this product has been designed to enable the reuse of parts and facilitate the recycling of certain materials.

Improper disposal may involve risks due to the presence of hazardous substances within electrical and electronic equipment, such as lead and BFR and other harmful components.

Check your local recycling services for electronic products.

<https://esg.asus.com/en/circular-economy/resource-regeneration/global-take-back-service>



Do not throw the battery in municipal waste. The symbol of the crossed out wheeled bin indicates that the battery should not be placed in municipal waste.



## France sorting and recycling information



FR

Cet appareil  
et ses accessoires  
se recyclent

À DÉPOSER  
EN MAGASIN



OU

À DÉPOSER  
EN DÉCHÈTERIE



Points de collecte sur [www.quefairede mesdechets.fr](http://www.quefairede mesdechets.fr)  
Privilégiez la réparation ou le don de votre appareil !

## Notices for Wi-Fi model

### FCC RF Caution Statement

**WARNING:** Any changes or modifications not expressly approved by the party responsible for compliance could void your authority to operate the equipment.

### FCC 5.925-7.125 GHz Caution Statement

Operation of transmitters in the 5.925-7.125 GHz band is prohibited for control of or communications with unmanned aircraft systems.

### RF exposure warning

This equipment must be installed and operated in accordance with provided instructions and the antenna(s) used for this transmitter must be installed to provide a separation distance of at least 20 cm from all persons and must not be co-located or operating in conjunction with any other antenna or transmitter. End-users and installers must be provided with antenna installation instructions and transmitter operating conditions for satisfying RF exposure compliance.

### Compliance Statement of Innovation, Science and Economic Development Canada (ISED)

This device complies with Innovation, Science and Economic Development Canada licence exempt RSS standard(s). Operation is subject to the following two conditions: (1) this device may not cause interference, and (2) this device must accept any interference, including interference that may cause undesired operation of the device.

Operation in the band 5150–5250 MHz is only for indoor use to reduce the potential for harmful interference to co-channel mobile satellite systems.

CAN ICES(B)/NMB(B)

### Déclaration de conformité de Innovation, Sciences et Développement économique Canada (ISED)

Le présent appareil est conforme aux CNR d'Innovation, Sciences et Développement économique Canada applicables aux appareils radio exempts de licence. L'exploitation est autorisée aux deux conditions suivantes : (1) l'appareil ne doit pas produire de brouillage, et (2) l'utilisateur de l'appareil doit accepter tout brouillage radioélectrique subi, même si le brouillage est susceptible d'en compromettre le fonctionnement.

La bande 5150–5250 MHz est réservée uniquement pour une utilisation à l'intérieur afin de réduire les risques de brouillage préjudiciable aux systèmes de satellites mobiles utilisant les mêmes canaux.

CAN ICES(B)/NMB(B)

## ISED 5.925-7.125 GHz Caution Statement (RLAN devices)

- Devices shall not be used for control of or communications with unmanned aircraft systems.
  - Devices shall not be used on oil platforms.
  - Devices shall not be used on aircraft, except for the low-power indoor access points, indoor subordinate devices, low-power client devices, and very low-power devices operating in the 5925-6425 MHz band, that may be used on large aircraft as defined in the Canadian Aviation Regulations, while flying above 3,048 metres (10,000 feet).
  - Devices shall not be used on automobiles.
  - Devices shall not be used on trains.
  - Devices shall not be used on maritime vessels.
- 
- Les dispositifs ne doivent pas être utilisés pour commander des systèmes d'aéronef sans pilote ni pour communiquer avec de tels systèmes;
  - Les dispositifs ne doivent pas être utilisés sur les plateformes de forage pétrolier;
  - Les dispositifs ne doivent pas être utilisés dans les aéronefs, à l'exception des points d'accès intérieurs de faible puissance, des dispositifs subordonnés intérieurs, des dispositifs clients de faible puissance et des dispositifs de très faible puissance fonctionnant dans la bande de 5 925 à 6 425 MHz, qui peuvent être utilisés dans les gros aéronefs tel qu'il est défini dans le Règlement de l'aviation canadien, et ce, lorsqu'ils volent à une altitude supérieure à 3 048 mètres (10 000 pieds).
  - Les dispositifs ne doivent pas être utilisés dans les automobiles;
  - Les dispositifs ne doivent pas être utilisés dans les trains;
  - Les dispositifs ne doivent pas être utilisés sur les navires maritimes.

### Précautions d'emploi de l'appareil :

- a. Soyez particulièrement vigilant quant à votre sécurité lors de l'utilisation de cet appareil dans certains lieux (les avions, les aéroports, les hôpitaux, les stations-service et les garages professionnels).
- b. Évitez d'utiliser cet appareil à proximité de dispositifs médicaux implantés. Si vous portez un implant électronique (stimulateurs cardiaques, pompes à insuline, neurostimulateurs...), veuillez impérativement respecter une distance minimale de 15 centimètres entre cet appareil et l'implant pour réduire les risques d'interférence.
- c. Utilisez cet appareil dans de bonnes conditions de réception pour minimiser le niveau de rayonnement. Ce n'est pas toujours le cas dans certaines zones ou situations, notamment dans les parkings souterrains, dans les ascenseurs, en train ou en voiture ou tout simplement dans un secteur mal couvert par le réseau.
- d. Tenez cet appareil à distance du ventre des femmes enceintes et du bas-ventre des adolescents.

### NCC: Wireless Statement

取得審驗證明之低功率射頻器材，非經核准，公司、商號或使用者均不得擅自變更頻率、加大功率或變更原設計之特性及功能。低功率射頻器材之使用不得影響飛航安全及干擾合法通信；經發現有干擾現象時，應立即停用，並改善至無干擾時方得繼續使用。前述合法通信，指依電信管理法規定作業之無線電通信。低功率射頻器材須忍受合法通信或工業、科學及醫療用電波輻射性電機設備之干擾。

應避免影響附近雷達系統之操作。

# Japan RF Equipment Statement

## 屋外での使用について

5GHz帯 (W52/53) 及び6GHz帯 (LPI) の屋外での使用は、電波法により禁じられています (法令により許可された場合は除く) (6GHz帯は対応製品のみ)。

## 法律および規制遵守

本製品は電波法及びこれに基づく命令の定めるところに従い使用してください。日本国外では、その国の法律または規制により、本製品の使用ができないことがあります。このような国では、本製品を運用した結果、罰せられることがあります。当社は一切責任を負いかねますのでご了承ください。

### Simplified UKCA Declaration of Conformity

ASUSTek Computer Inc. hereby declares that this device is in compliance with the essential requirements and other relevant provisions of The Radio Equipment Regulations 2017 (S.I. 2017/1206). Full text of UKCA declaration of conformity is available at <https://www.asus.com/support/>.

The WiFi operating in the band 5150-5350MHz shall be restricted to indoor use for the country listed below:

# UK

### UKCA RF Output table (The Radio Equipment Regulations 2017)

Model: RTL8851BE

- Low power indoor (LPI) Wi-Fi 5.945-6.425 GHz devices:  
The device is restricted to indoor use only when operating in the 5925 to 6425 MHz frequency ranges in the UK.
- Very Low Power (VLP) Wi-Fi 5.945-6.425 GHz devices (portable devices):  
The device is not permitted to be used on Unmanned Aircraft Systems (UAS) when operating in the 5925 to 6425 MHz frequency range in the UK.

Function	Frequency	Maximum Output Power EIPR (mW)
WiFi	2.4 - 2.4835 GHz	<100
	5.15 - 5.35 GHz	<200
	5.47 - 5.725 GHz	<200
	5.725 - 5.875 GHz*	<25
	5.925 - 6.425 GHz	<200
Bluetooth	2.4 - 2.4835 GHz	<100

Receiver category 1

\* Non-Intel modules: 5.725 - 5.85 GHz

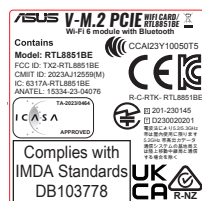

### Simplified EU Declaration of Conformity

ASUSTek Computer Inc. hereby declares that this device is in compliance with the essential requirements and other relevant provisions of Directive 2014/53/EU. Full text of EU declaration of conformity is available at <https://www.asus.com/support/>.

The WiFi operating in the band 5150-5350 MHz shall be restricted to indoor use for countries listed in the table below:

- Low power indoor (LPI) Wi-Fi 5.945-6.425 GHz devices:  
The device is restricted to indoor use only when operating in the 5945 to 6425 MHz frequency range in Austria (AT), Belgium (BE), Bulgaria (BG), Cyprus (CY), Czech Republic (CZ), Estonia (EE), France (FR), Germany (DE), Iceland (IS), Ireland (IE), Latvia (LV), Luxembourg (LU), Netherlands (NL), Norway (NO), Romania (RO), Slovakia (SK), Slovenia (SI), Spain (ES), Switzerland (CH)
- Very Low Power (VLP) Wi-Fi 5.945-6.425 GHz devices (portable devices):  
The device is not permitted to be used on Unmanned Aircraft Systems (UAS) when operating in the 5945 to 6425 MHz frequency range in Austria (AT), Belgium (BE), Bulgaria (BG), Cyprus (CY), Czech Republic (CZ), Estonia (EE), France (FR), Germany (DE), Iceland (IS), Ireland (IE), Latvia (LV), Luxembourg (LU), Netherlands (NL), Norway (NO), Romania (RO), Slovakia (SK), Slovenia (SI), Spain (ES), Switzerland (CH)

### Déclaration de conformité simplifiée de l'UE

ASUSTEK COMPUTER INC. déclare par la présente que cet appareil est conforme aux critères essentiels et autres clauses pertinentes de la directive 2014/53/UE. La déclaration de conformité de l'UE peut être téléchargée à partir du site internet suivant : <https://www.asus.com/fr/support/>.

Dans la plage de fréquences 5150-5350 MHz, le WiFi est restreint à une utilisation en intérieur dans les pays listés ci-dessous :

- Pour les appareils WiFi LPI (Low Power Indoor) dans la plage 5,945-6,425 GHz :  
L'appareil est limité à une utilisation en intérieur uniquement lorsqu'il fonctionne dans la plage de fréquences 5945-6425 MHz en Autriche (AT), Belgique (BE), Bulgarie (BG), Chypre (CY), République tchèque (CZ), Estonie (EE), France (FR), Allemagne (DE), Islande (IS), Irlande (IE), Lettonie (LV), Luxembourg (LU), Pays-Bas (NL), Norvège (NO), Roumanie (RO), Slovaquie (SK), Slovaquie (SK), Espagne (ES), Suisse (CH).
- Pour les appareils portables WiFi VLP (Very Low Power) dans la plage 5,945-6,425 GHz :  
L'appareil n'est pas autorisé à être utilisé sur des systèmes d'aéronefs sans pilote (UAS) lorsqu'il fonctionne dans la plage de fréquences 5945-6425 MHz en Autriche (AT), Belgique (BE), Bulgarie (BG), Chypre (CY), République tchèque (CZ), Estonie (EE), France (FR), Allemagne (DE), Islande (IS), Irlande (IE), Lettonie (LV), Luxembourg (LU), Pays-Bas (NL), Norvège (NO), Roumanie (RO), Slovaquie (SK), Slovaquie (SK), Espagne (ES), Suisse (CH).

### Vereinfachte EU-Konformitätserklärung

ASUSTek Computer Inc. erklärt hiermit, dass dieses Gerät mit den wesentlichen Anforderungen und anderen relevanten Bestimmungen der Richtlinie 2014/53/EU übereinstimmt. Der gesamte Text der EU-Konformitätserklärung ist verfügbar unter: <https://www.asus.com/support/>.

Der WLAN-Betrieb im Band von 5150-5350 MHz ist für die in der unteren Tabelle aufgeführten Länder auf den Innenbereich beschränkt:

- Low Power Indoor (LPI) Wi-Fi 5,945 bis 6,425 GHz-Geräte:  
Das Gerät ist auf den Innenbereich beschränkt, wenn es im Frequenzbereich von 5945 MHz bis 6425 MHz in Österreich (AT), Belgien (BE), Bulgarien (BG), Zypern (CY), der Tschechischen Republik (CZ), Estland (EE), Frankreich (FR), Deutschland (DE), Island (IS), Irland (IE), Lettland (LV), Luxemburg (LU), den Niederlanden (NL), Norwegen (NO), Rumänien (RO), der Slowakei (SK), Slowenien (SI), Spanien (ES) und der Schweiz (CH) betrieben wird.
- Very Low Power (VLP) Wi-Fi 5,945 bis 6,425 GHz-Geräte (tragbare Geräte):  
Das Gerät darf nicht auf unbemannten Luftfahrzeugsystemen (UAS) verwendet werden, wenn es im Frequenzbereich von 5945 MHz bis 6425 MHz in Österreich (AT), Belgien (BE), Bulgarien (BG), Zypern (CY), der Tschechischen Republik (CZ), Estland (EE), Frankreich (FR), Deutschland (DE), Island (IS), Irland (IE), Lettland (LV), Luxemburg (LU), den Niederlanden (NL), Norwegen (NO), Rumänien (RO), der Slowakei (SK), Slowenien (SI), Spanien (ES) und der Schweiz (CH) betrieben wird.

### Dichiarazione di conformità UE semplificata

ASUSTek Computer Inc. con la presente dichiara che questo dispositivo è conforme ai requisiti essenziali e alle altre disposizioni pertinenti con la direttiva 2014/53/UE. Il testo completo della dichiarazione di conformità UE è disponibile all'indirizzo: <https://www.asus.com/support/>.

L'utilizzo della rete Wi-Fi con frequenza compresa nell'intervallo 5150-5350MHz deve essere limitato all'interno degli edifici per i paesi presentati nella seguente tabella:

- Dispositivi LPI (Low Power Indoor) Wi-Fi 5.945-6.425 GHz:  
Il dispositivo è limitato all'uso in ambienti interni quando funziona nella gamma di frequenza da 5945 a 6425 MHz in Austria (AT), Belgio (BE), Bulgaria (BG), Cipro (CY), Repubblica Ceca (CZ), Estonia (EE), Francia (FR), Germania (DE), Islanda (IS), Irlanda (IE), Lettonia (LV), Lussemburgo (LU), Paesi Bassi (NL), Norvegia (NO), Romania (RO), Slovacchia (SK), Slovenia (SI), Spagna (ES), Svizzera (CH).
- Dispositivi VLP (Very Low Power) Wi-Fi 5.945-6.425 GHz (dispositivi portatili):  
Il dispositivo non può essere utilizzato su Unmanned Aircraft Systems (UAS) quando opera nella gamma di frequenza da 5945 a 6425 MHz in Austria (AT), Belgio (BE), Bulgaria (BG), Cipro (CY), Repubblica Ceca (CZ), Estonia (EE), Francia (FR), Germania (DE), Islanda (IS), Irlanda (IE), Lettonia (LV), Lussemburgo (LU), Paesi Bassi (NL), Norvegia (NO), Romania (RO), Slovacchia (SK), Slovenia (SI), Spagna (ES), Svizzera (CH).

### Изделие соответствует основным требованиям директив ЕС

Настоящим, ASUSTEK COMPUTER INC, заявляет, что устройство соответствует основным требованиям и другим соответствующим условиям директивы 2014/53/ЕU. Полный текст декларации соответствия ЕС доступен на <https://www.asus.com/ru/support/>.

Работа WiFi в диапазоне частот 5150-5350 должна быть ограничена использованием в помещениях для стран, перечисленных в таблице ниже:

- Устройства Wi-Fi 5,945–6,425 ГГц для помещений с низким энергопотреблением (LPI): Устройство предназначено для использования внутри помещений только при работе в диапазоне частот от 5945 до 6425 МГц в Австрии (AT), Бельгии (BE), Болгарии (BG), Кипре (CY), Чехии (CZ), Эстонии (EE), Франции (FR), Германии (DE), Исландии (IS), Ирландии (IE), Латвии (LV), Люксембурге (LU), Нидерландах (NL), Норвегии (NO), Румынии (RO), Словакии (SK), Словении (SI), Испании (ES), Швейцарии (CH).
- Устройства Wi-Fi с очень низким энергопотреблением (VLP) 5,945–6,425 ГГц (портативные устройства): Устройство не разрешается использовать в беспилотных авиационных системах (ЕАС) при работе в диапазоне частот от 5945 до 6425 МГц в Австрии (AT), Бельгии (BE), Болгарии (BG), Кипре (CY), Чехии (CZ), Эстонии (EE), Франции (FR), Германии (DE), Исландии (IS), Ирландии (IE), Латвии (LV), Люксембурге (LU), Нидерландах (NL), Норвегии (NO), Румынии (RO), Словакии (SK), Словении (SI), Испании (ES), Швейцарии (CH).

### Опростена декларация за съответствие на ЕС

С настоящото ASUSTEK Computer Inc. декларира, че това устройство е в съответствие със съществени изисквания и другите приложими постановления на свързаната Директива 2014/53/ЕС. Пълният текст на ЕС декларация за съвместимост е достъпен на адрес <https://www.asus.com/support/>.

WiFi, работеща в диапазон 5150-5350MHz, трябва да се ограничи до употреба на закрито за страните, посочени в таблицата до-долу:

- Ниско захранване на закрито (LPI) Wi-Fi 5,945-6,425 GHz устройства:  
Устройството е ограничено до употреба само на закрито, когато работи в честотния диапазон от 5945 до 6425 в Австрия (AT), Бельгия (BE), България (BG), Кипър (CY), Чехия (CZ), Estonia (EE), Франция (FR), Германия (DE), Islandия (IS), Ирландия (IE), Латвия (LV), Люксембург (LU), Нидерландия (NL), Норвегия (NO), Румъния (RO), Словакия (SK), Словения (SI), Испания (ES), Швейцария (CH).
- Много ниско захранване (VLP) Wi-Fi 5,945-6,425 GHz устройства (переносими устройства):  
Устройството не е разрешено за употреба в беспилотни летателни средства (UAS) при работа в честотния диапазон от 5945 до 6425 MHz в Австрия (AT), Бельгия (BE), България (BG), Кипър (CY), Чехия (CZ), Estonia (EE), Франция (FR), Германия (DE), Islandия (IS), Ирландия (IE), Латвия (LV), Люксембург (LU), Нидерландия (NL), Норвегия (NO), Румъния (RO), Словакия (SK), Словения (SI), Испания (ES), Швейцария (CH).

## Pojednostavljena EU Izjava o sukladnosti

ASUSTek Computer Inc. ovim izjavljuje da je ovaj uređaj sukladan s bitnim zahtjevima i ostalim odgovarajućim odredbama direktive 2014/53/EU. Cijeli tekst EU izjave o sukladnosti dostupan je na <https://www.asus.com/support/>.

WiFi koji radi na opsegu frekvencija 5150-5350 MHz bit će ograničen uza potrebu u zatvorenom prostoru u zemljama na donjem popisu:

- Unutarnji uređaji male snage (LPI) Wi-Fi 5,945 – 6,425 GHz:  
Uređaj je ograničen u uporabu u zatvorenom prostoru samo kada radi u frekvencijskom pojasu od 5945 do 6425 MHz u Austrija (AT), Belgija (BE), Bugarskoj (BG), Cipru (CY), Češkoj (CZ), Estoniji (EE), Francuskoj (FR), Njemačkoj (DE), Islandu (IS), Irskoj (IE), Latvija (LV), Luksemburg (LU), Nizozemskoj (NL), Norveška (NO), Rumunjska (RO), Slovačka (SK), Slovenija (SI), Španjolskoj (ES), Švicarska (CH).
- Uređaji vrlo male snage (VLP) Wi-Fi 5,945 – 6,425 GHz (prijenosni uređaji):  
Uređaj nije dopušteno koristiti u sustavima bespilnotnih letjelica (UAS) kada radi u frekvencijskom pojasu od 5945 do 6425 MHz u Austrija (AT), Belgija (BE), Bugarskoj (BG), Cipru (CY), Češkoj (CZ), Estoniji (EE), Francuskoj (FR), Njemačkoj (DE), Islandu (IS), Irskoj (IE), Latvija (LV), Luksemburg (LU), Nizozemskoj (NL), Norveška (NO), Rumunjska (RO), Slovačka (SK), Slovenija (SI), Španjolskoj (ES), Švicarska (CH).

## Zjednodušene prohlášení o shodě EU

Společnost ASUSTek Computer Inc. tímto prohlašuje, že toto zařízení splňuje základní požadavky a další příslušná ustanovení směrnice 2014/53/EU. Plné znění prohlášení o shodě EU je k dispozici na adrese <https://www.asus.com/support/>.

V zemích uvedených v tabulce je provoz sítě Wi-Fi a frekvenciím rozsahu 5 150 - 5 350 MHz povoleno pouze ve vnitřních prostorech:

- Zařízení Wi-Fi s nízkým výkonem („LPI“) pro pásmo 5,945 – 6,425 GHz:  
Při provozu ve frekvenciím pásmu 5945 až 6425 MHz je používání tohoto zařízení omezeno pouze na interiéry v Rakousku (AT), Belgii (BE), Bulharsku (BG), Kypru (CY), České republice (CZ), Estonsku (EE), Francii (FR), Německu (DE), Islandu (IS), Irsku (IE), Lotyšsku (LV), Lucembursku (LU), Nizozemsku (NL), Norsku (NO), Rumunsku (RO), Slovensku (SK), Slovinsku (SI), Španělsku (ES), Švýcarsku (CH).
- Zařízení Wi-Fi s velmi nízkým výkonem („VLP“) pro pásmo 5,945 – 6,425 GHz (přenosná zařízení):  
Při provozu ve frekvenciím pásmu 5945 až 6425 MHz není povoleno používat toto zařízení v systémech bezpilnotních letadel (UAS) v Rakousku (AT), Belgii (BE), Bulharsku (BG), Kypru (CY), České republice (CZ), Estonsku (EE), Francii (FR), Německu (DE), Islandu (IS), Irsku (IE), Lotyšsku (LV), Lucembursku (LU), Nizozemsku (NL), Norsku (NO), Rumunsku (RO), Slovensku (SK), Slovinsku (SI), Španělsku (ES), Švýcarsku (CH).

## Forenklet EU-overensstemmelseserklæring

ASUSTek Computer Inc. erklærer hermed at denne enhed er i overensstemmelse med hovedkravene og øvrige relevante bestemmelser i direktivet 2014/53/EU. Hele EU-overensstemmelseserklæringen kan findes på <https://www.asus.com/support/>.

Wi-Fi, der bruger 5150-5350 MHz skal begrænses til indendørs brug i lande, der er anført i tabellen:

- Lav effekt indendørs (LPI) Wi-Fi 5,945-6,425 GHz-enheder:  
Enheden må kun bruges indendørs, når den bruges inden for frekvensområdet 5945 til 6425 MHz i Østrig (AT), Belgien (BE), Bulgarien (BG), Cypern (CY), Tjekkiet (CZ), Estland (EE), Frankrig (FR), Tyskland (DE), Island (IS), Irland (IE), Letland (LV), Luxembourg (LU), Holland (NL), Norge (NO), Rumænien (RO), Slovakiet (SK), Slovenien (SI), Spanien (ES), Schweiz (CH).
- Meget lav strøm indendørs (VLP) Wi-Fi 5,945-6,425 GHz-enheder (bærbare enheder):  
Enheden må kun bruges i ubemandede flýsystemer (UAS), når den bruges inden for frekvensområdet 5945 til 6425 MHz i Østrig (AT), Belgien (BE), Bulgarien (BG), Cypern (CY), Tjekkiet (CZ), Estland (EE), Frankrig (FR), Tyskland (DE), Island (IS), Irland (IE), Letland (LV), Luxembourg (LU), Holland (NL), Norge (NO), Rumænien (RO), Slovakiet (SK), Slovenien (SI), Spanien (ES), Schweiz (CH).

## Vereenvoudigd EU-conformiteitsverklaring

ASUSTek Computer Inc. verklaart hierbij dat dit apparaat voldoet aan de essentiële vereisten en andere relevante bepalingen van Richtlijn 2014/53/EU. De volledige tekst van de EU-conformiteitsverklaring is beschikbaar op <https://www.asus.com/support/>.

De WiFi op 5150-5350MHz zal beperkt zijn tot binnengebruik voor in de tabel vermelde landen:

- LPI (Low Power Indoor=laag vermogen binnenshuis) Wi-Fi 5.945-6.425 GHz-apparaten:  
Het apparaat is beperkt tot enkel binnengebruik bij bediening in het frequentiebereik van 5945 tot 6425 MHz in Oostenrijk (AT), België (BE), Bulgarije (BG), Cyprus (CY), Tsjechische Republiek (CZ), Estland (EE), Frankrijk (FR), Duitsland (DE), IJsland (IS), Ierland (IE), Letland (LV), Luxemburg (LU), Nederland (NL), Noorwegen (NO), Roemenië (RO), Slowakije (SK), Slovenië (SI), Spanje (ES), Zwitserland (CH).
- VLP (Very Low Power = zeer laag vermogen) Wi-Fi 5.945-6.425 GHz-apparaten (draagbare apparaten):  
Het apparaat mag niet worden gebruikt in onbemande luchtvaartsystemen (UAS) bij bediening in het frequentiebereik van 5945 tot 6425 MHz in Oostenrijk (AT), België (BE), Bulgarije (BG), Cyprus (CY), Tsjechische Republiek (CZ), Estland (EE), Frankrijk (FR), Duitsland (DE), IJsland (IS), Ierland (IE), Letland (LV), Luxemburg (LU), Nederland (NL), Noorwegen (NO), Roemenië (RO), Slowakije (SK), Slovenië (SI), Spanje (ES), Zwitserland (CH).

## Lihstustatud EU vastavusdeklaratsioon

Käesolevaga kinnitab ASUSTek Computer Inc. et seade vastab direktiivi 2014/53/EU oluliste nõuetele ja teiste asjakohaste sätetele. EL vastavusdeklaratsiooni täisteksti on saadaval veebisaidil <https://www.asus.com/support/>.

Sagedusvahemikus 5150-5350 MHz töötava WiFi kasutamine on järgmistes riikides lubatud ainult siseruumides:

- Madala võimsusega (LPI) Wi-Fi 5.945-6.425 GHz seadmed:  
Sagedusalas 5945 kuni 6425 MHz töötavate seadmete kasutamine on siseruumides piiratud järgmistes riikides: Austria (AT), Belgia (BE), Bulgaaria (BG), Kypros (CY), Tšehhi Vabariik (CZ), Eesti (EE), Prantsusmaa (FR), Saksamaa (DE), Island (IS), Iirimaa (IE), Läti (LV), Luksemburg (LU), Holland (NL), Norra (NO), Rumeenia (RO), Slovakkia (SK), Sloveenia (SI), Hispaania (ES), Šveits (CH).
- Väga madala võimsusega (VLP) Wi-Fi 5.945-6.425 GHz seadmed (kantavad seadmed):  
Sagedusalas 5945 kuni 6425 MHz töötavate seadmete kasutamine on mehitanud õhusüsteemides (UAS) keelatud järgmistes riikides: Austria (AT), Belgia (BE), Bulgaaria (BG), Kypros (CY), Tšehhi Vabariik (CZ), Eesti (EE), Prantsusmaa (FR), Saksamaa (DE), Island (IS), Iirimaa (IE), Läti (LV), Luksemburg (LU), Holland (NL), Norra (NO), Rumeenia (RO), Slovakkia (SK), Sloveenia (SI), Hispaania (ES), Šveits (CH).

## Eurooppa - EY-n vaatimustenmukaisuusvakuutus

ASUSTek Computer Inc. ilmoittaa täten, että tämä laite on direktiivin 2014/53/EU olennainen vaatimusten ja muiden asiaankuuluvien lisäysten mukainen. Koko EY:n vaatimustenmukaisuusvakuutuksen teksti on luettavissa osoitteessa <https://www.asus.com/support/>.

5 150 - 5 350 MHz:n taajuudella toimiva WiFi on rajoitettu sisäkäyttöön taulukoissa luetelluissa maissa:

- Pienitehoiset sisäkäyttöön (LPI) Wi-Fi 5,945-6,425 GHz-laitteet:  
Laitte on rajoitettu sisäkäyttöön vain, kun se toimii 5945-6425 MHz taajuusalueella itävalta (AT), Belgiassa (BE), Bulgariassa (BG), Kyproksella (CY), Tšekin tasavallassa (CZ), Virossa (EE), Ranskassa (FR), Saksassa (DE), Islannissa (IS), Irlannissa (IE), Latviassa (LV), Luxemburgissa (LU), Alankomaissa (NL), Norjassa (NO), Romaniassa (RO), Slovakiassa (SK), Sloveniassa (SI), Espanjassa (ES), Sveitsissä (CH).
- Erittäin pienitehoiset (VLP) Wi-Fi 5,945-6,425 GHz-laitteet (kantavat laitteet):  
Laitteita ei saa käyttää miehittämättömissä lentokonejärjestelmissä (UAS) toimittaessa 5945–6425 MHz taajuusalueella itävalta (AT), Belgiassa (BE), Bulgariassa (BG), Kyproksella (CY), Tšekin tasavallassa (CZ), Virossa (EE), Ranskassa (FR), Saksassa (DE), Islannissa (IS), Irlannissa (IE), Latviassa (LV), Luxemburgissa (LU), Alankomaissa (NL), Norjassa (NO), Romaniassa (RO), Slovakiassa (SK), Sloveniassa (SI), Espanjassa (ES), Sveitsissä (CH).

## Απλοποιημένη Δήλωση Συμμόρφωσης ΕΕ

Λιά το παρόντος η ASUSTek Computer Inc. δηλώνει ότι αυτή η συσκευή είναι συμμόρφη με τα βασικά προϋποθέσεις και άλλες σχετικές διατάξεις της οδηγίας 2014/53/ΕΕ. Το πλήρες κείμενο της δήλωσης συμμόρφωσης της ΕΕ είναι διαθέσιμο στη διεύθυνση <https://www.asus.com/support/>.

To WiFi που λειτουργεί στη ζώνη 5150-5350MHz περιορίζεται για χρήση σε εσωτερικούς χώρους για τις χώρες που αναφέρονται στον παρακάτω πίνακα:



- a. Urządzenia Wi-Fi o niskim poziomie mocy w pomieszczeniach (LPI) w zakresie 5,945–6,425 GHz:  
W Austrii (AT), Belgii (BE), Bułgarii (BG), Cyprze (CY), Czechach (CZ), Estonii (EE), Francji (FR), Niemczech (DE), Islandii (IS), Irlandii (IE), Lotwie (LV), Luksemburgu (LU), Holandii (NL), Norwegia (NO), Rumunia (RO), Słowacji (SK), Słowenii (SI), Hiszpanii (ES) i Szwajcarii (CH) działanie urządzenia w zakresie częstotliwości od 5945 do 6425 MHz jest ograniczone do użytku wewnątrz pomieszczeń.
- b. Urządzenia Wi-Fi o bardzo niskim poziomie mocy (VLP) w zakresie 5,945–6,425 GHz (urządzenia przenośne):  
W Austrii (AT), Belgii (BE), Bułgarii (BG), Cyprze (CY), Czechach (CZ), Estonii (EE), Francji (FR), Niemczech (DE), Islandii (IS), Irlandii (IE), Lotwie (LV), Luksemburgu (LU), Holandii (NL), Norwegia (NO), Rumunia (RO), Słowacji (SK), Słowenii (SI), Hiszpanii (ES) i Szwajcarii (CH) urządzenie działające w zakresie częstotliwości od 5945 do 6425 MHz nie może być używane w bezzałogowych systemach latających (UAS).

#### Declaração de Conformidade Simplificada da UE

A ASUSTek Computer Inc. declara que este dispositivo está em conformidade com os requisitos essenciais e outras disposições relevantes da Diretiva 2014/53/UE. O texto integral da declaração de conformidade da UE está disponível em <https://www.asus.com/support/>.

A utilização das frequências WiFi de 5150 a 5350MHz está restrita a ambientes interiores nos países apresentados na tabela:

- a. Dispositivos Wi-Fi 5,945-6,425 GHz de baixa potência para interiores (LPI):  
O dispositivo restringe-se à utilização em locais interiores apenas quando funcionar na gama de frequências de 5945 a 6425 MHz na Áustria (AT), Bélgica (BE), Bulgária (BG), Chipre (CY), República Checa (CZ), Estónia (EE), França (FR), Alemanha (DE), Islandia (IS), Irlanda (IE), Letónia (LV), Luxemburgo (LU), Países Baixos (NL), Noruega (NO), Roménia (RO), Eslováquia (SK), Eslovénia (SI), Espanha (ES), Suíça (CH).
- b. Dispositivos Wi-Fi 5,945-6,425 GHz de muito baixa potência (VLP) (dispositivos portáteis):  
Não é permitida a utilização do dispositivo em veículos aéreos não tripulados (UAS) quando o mesmo funcionar na gama de frequências de 5945 a 6425 MHz na Áustria (AT), Bélgica (BE), Bulgária (BG), Chipre (CY), República Checa (CZ), Estónia (EE), França (FR), Alemanha (DE), Islandia (IS), Irlanda (IE), Letónia (LV), Luxemburgo (LU), Países Baixos (NL), Noruega (NO), Roménia (RO), Eslováquia (SK), Eslovénia (SI), Espanha (ES), Suíça (CH).

#### Declarație de conformitate UE, versiune simplificată

Prin prezenta, ASUSTek Computer Inc. declară că acest dispozitiv este în conformitate cu regulamentele esențiale și cu celelalte prevederi relevante ale Directivei 2014/53/UE. Textul complet al declarației de conformitate UE este disponibil la adresa <https://www.asus.com/support/>.

Pentru țările listate în tabelul de mai jos, rețelele WiFi care funcționează în banda de frecvență de 5.150-5.350 MHz trebuie utilizate doar în interior:

- a. Dispozitive Wi-Fi cu consum redus de energie pentru interior (LPI) de 5,945-6,425 GHz:  
Dispozitivul este restricționat pentru utilizare exclusivă în interior atunci când funcționează în gama de frecvențe de la 5945 la 6425 MHz în Austria (AT), Belgia (BE), Bulgaria (BG), Cipru (CY), Republica Cehă (CZ), Estonia (EE), Franța (FR), Germania (DE), Islanda (IS), Irlanda (IE), Letonia (LV), Luxemburg (LU), Țările de Jos (NL), Norvegia (NO), România (RO), Slovacia (SK), Slovenia (SI), Spania (ES), Switzerland (CH).
- b. Dispozitive Wi-Fi de foarte mică putere (VLP) de 5,945-6,425 GHz (dispozitive portabile):  
Nu este permisă utilizarea dispozitivului pe sisteme de aeronave fără pilot la bord (UAS) atunci când funcționează în gama de frecvențe 5945-6425 MHz în Austria (AT), Belgia (BE), Bulgaria (BG), Cipru (CY), Republica Cehă (CZ), Estonia (EE), Franța (FR), Germania (DE), Islanda (IS), Irlanda (IE), Letonia (LV), Luxemburg (LU), Țările de Jos (NL), Norvegia (NO), România (RO), Slovacia (SK), Slovenia (SI), Spania (ES), Switzerland (CH).

#### Poenodostavljena Deklaracija o usaglašenosti EU

ASUSTek Computer Inc. ovim izjavljuje da je ovaj uređaj usaglašen sa osnovnim zahtevima i drugim relevantnim odredbama Direktive 2014/53/EU. Ceo tekst Deklaracije o usaglašenosti EU dostupan je na lokaciji <https://www.asus.com/support/>.

WiFi koji radi u frekventnom opsegu od 5150 MHz do 5350 MHz ograničen je isključivo na upotrebu u zatvorenom prostoru za zemlje navedene u tabeli ispod:

- a. Wi-Fi 5.945-6.425 GHz uređaji s niskom potrošnjom za zatvoreni prostor (LPI):  
Ovaj uređaj je ograničen na upotrebu samo u zatvorenom prostoru kada radi u frekventnom opsegu od 5945 do 6425 MHz u Austriji (AT), Belgiji (BE), Bugarskoj (BG), Cipru (CY), Češkoj Republici (CZ), Estoniji (EE), Francuskoj (FR), Nemačkoj (DE), Islandu (IS), Irskoj (IE), Letoniji (LV), Luksemburgu (LU), Holandiji (NL), Norveška (NO), Rumuniji (RO), Slovačka (SK), Sloveniji (SI), Španiji (ES), Švajcarska (CH).
- b. Wi-Fi 5.945-6.425 GHz uređaji s veoma niskom potrošnjom (VLP) (prenosivi uređaji):  
Nije dozvoljeno da se ovaj uređaj koristi na sistemima bespilotnih letelica (UAS) kada radi u frekventnom opsegu od 5945 do 6425 MHz u Austriji (AT), Belgiji (BE), Bugarskoj (BG), Cipru (CY), Češkoj Republici (CZ), Estoniji (EE), Francuskoj (FR), Nemačkoj (DE), Islandu (IS), Irskoj (IE), Letoniji (LV), Luksemburgu (LU), Holandiji (NL), Norveška (NO), Rumuniji (RO), Slovačka (SK), Sloveniji (SI), Španiji (ES), Švajcarska (CH).

#### Zjednodušené vyhlásenie o zhode platné pre EÚ

Spoločnosť ASUSTek Computer Inc. týmto vyhlasuje, že toto zariadenie je v súlade so základnými požiadavkami a ďalšími príslušnými ustanoveniami smernice č. 2014/53/EU. Plné znenie vyhlásenia o zhode pre EÚ je k dispozícii na lokalite <https://www.asus.com/support/>.

Činnosť WiFi v pásme 5150 - 5350 MHz bude obmedzená na použitie vo vnútornom prostredí pre krajiny uvedené v tabuľke nižšie:

- a. Zariadenia s Wi-Fi 5,945 - 6,425 GHz s nízkym výkonom určené do vnútorného prostredia (LPI):  
Toto zariadenie je obmedzené len na použitie vo vnútornom prostredí pri prevádzke vo frekvenčnom pásme 5945 až 6425 MHz v Rakúsku (AT), Belgicku (BE), Bulharsku (BG), na Cypru (CY), v Českej republike (CZ), Estónsku (EE), vo Francúzsku (FR), Nemecku (DE), na Islande (IS), v Irsku (IE), Lotyšsku (LV), Luxemburgu (LU), Holandsku (NL), Nórsku (NO), Rumunsku (RO), Slovensku (SK), Slovensku (SI), Španielsku (ES), Švajčiarsku (CH).
- b. Zariadenia s Wi-Fi 5,945 - 6,425 GHz s veľmi nízkym výkonom (VLP) (prenosné zariadenia):  
Toto zariadenie sa nesmie používať v bezpilotných leteckých systémoch (UAS) pri prevádzke vo frekvenčnom pásme 5945 až 6425 MHz v Rakúsku (AT), Belgicku (BE), Bulharsku (BG), na Cypru (CY), v Českej republike (CZ), Estónsku (EE), vo Francúzsku (FR), Nemecku (DE), na Islande (IS), v Irsku (IE), Lotyšsku (LV), Luxemburgu (LU), Holandsku (NL), Nórsku (NO), Rumunsku (RO), Slovensku (SK), Slovensku (SI), Španielsku (ES), Švajčiarsku (CH).

#### Poenostavljena izjava EU o skladnosti

ASUSTek Computer Inc. tukaj izjavlja, da je ta naprava skladna s temeljnimi zahtevami in drugimi relevantnimi določili Direktive 2014/53/EU. Polno besedilo izjave EU o skladnosti je na voljo na <https://www.asus.com/support/>.

WiFi, ki deluje v pasovnem območju 5150–5350 MHz, mora biti v državah, navedenih v spodnjem seznamu, omejen na notranjo uporabo:

- a. Notranje naprave z nizko močjo (LPI) Wi-Fi 5,945–6,425 GHz:  
Naprava je omejena na uporabo v zaprtih prostorih, kadar deluje v frekvenčnem območju 5945 do 6425 MHz v Avstriji (AT), Belgiji (BE), Bolgariji (BG), na Cipru (CY), Češkem (CZ), v Estoniji (EE), Franciji (FR), Nemčiji (DE), na Islandiji (IS), Irskem (IE), v Latviji (LV), Luksemburgu (LU), na Nizozemskem (NL), Norveški (NO), Romuniji (RO), Slovaški (SK), Sloveniji (SI), Španiji (ES), Švica (CH).
- b. Naprave z zelo nizko močjo (VLP) Wi-Fi 5,945–6,425 GHz (prenosne naprave):  
Naprave ni dovoljeno uporabljati v sistemih brezpilotnih zrakoplovov (UAS), kadar delujejo v frekvenčnem območju 5945 do 6425 MHz v Avstriji (AT), Belgiji (BE), Bolgariji (BG), na Cipru (CY), Češkem (CZ), v Estoniji (EE), Franciji (FR), Nemčiji (DE), na Islandiji (IS), Irskem (IE), v Latviji (LV), Luksemburgu (LU), na Nizozemskem (NL), Norveški (NO), Romuniji (RO), Slovaški (SK), Sloveniji (SI), Španiji (ES), Švica (CH).

### Declaración de conformidad simplificada para la UE

Por la presente, ASUSTek Computer Inc. declara que este dispositivo cumple los requisitos básicos y otras disposiciones pertinentes de la directiva 2014/53/EU. En <https://www.asus.com/support/> está disponible el texto completo de la declaración de conformidad para la UE.

La conexión WiFi con una frecuencia de funcionamiento de 5150-5350 MHz se restringirá al uso en interiores para los países enumerados en tabla:

- Dispositivos con Wi-Fi de baja potencia para interiores (LPI) de 5,945-6,425 GHz.  
El dispositivo está restringido al uso en interiores únicamente cuando funciona en el intervalo de frecuencias de 5945 a 6425 MHz en Austria (AT), Bélgica (BE), Bulgaria (BG), Chipre (CY), República Checa (CZ), Estonia (EE), Francia (FR), Alemania (DE), Islandia (IS), Irlanda (IE), Letonia (LV), Luxemburgo (LU), Países Bajos (NL), Noruega (NO), Rumanía (RO), Eslovaquia (SK), Eslovenia (SI), España (ES) y Suiza (CH).
- Dispositivos con Wi-Fi de muy baja potencia (VLP) de 5,945-6,425 GHz (dispositivos portátiles):  
No está permitido usar el dispositivo en sistemas de aeronaves no tripuladas cuando funciona en el intervalo de frecuencias de 5945 a 6425 MHz en Austria (AT), Bélgica (BE), Bulgaria (BG), Chipre (CY), República Checa (CZ), Estonia (EE), Francia (FR), Alemania (DE), Islandia (IS), Irlanda (IE), Letonia (LV), Luxemburgo (LU), Países Bajos (NL), Noruega (NO), Rumanía (RO), Eslovaquia (SK), Eslovenia (SI), España (ES) y Suiza (CH).

### Förenklad EU-försäkran om överensstämmelse

ASUSTek Computer Inc. deklarerar härmed att denna enhet överensstämmer med de grundläggande kraven och andra relevanta bestämmelser i direktiv 2014/53/EU. Fullständig text av EU-försäkran om överensstämmelse finns på <https://www.asus.com/support/>.

Wi-Fi som använder 5150-5350 MHz kommer att begränsas för användning inomhus i de länder som anges i tabellen:

- Wi-Fi-enheter 5,945-6,425 GHz med låg effekt inomhus (LPI):  
Enheten är begränsad till användning inomhus enbart när den använder 5 945 till 6 425 MHz frekvensband i Österrike (AT), Belgien (BE), Bulgarien (BG), Cypern (CY), Tjeckien (CZ), Estland (EE), Frankrike (FR), Tyskland (DE), Island (IS), Irland (IE), Lettland (LV), Luxemburg (LU), Nederländerna (NL), Norge (NO), Rumänien (RO), Slovakien (SK), Slovenien (SI), Spanien (ES), Schweiz (CH).
- Wi-Fi-enheter 5,945-6,425 GHz med mycket låg effekt (VLP) (bärbara enheter):  
Enheten får inte användas på obemannade luftfartyg (UAS) när den använder 5 945 till 6 425 MHz frekvensband i Österrike (AT), Belgien (BE), Bulgarien (BG), Cypern (CY), Tjeckien (CZ), Estland (EE), Frankrike (FR), Tyskland (DE), Island (IS), Irland (IE), Lettland (LV), Luxemburg (LU), Nederländerna (NL), Norge (NO), Rumänien (RO), Slovakien (SK), Slovenien (SI), Spanien (ES), Schweiz (CH).

### Basistestirilmis AB Uyumluluk Bildirimi

ASUSTek Computer Inc., bu aygıtın 2014/53/EU Yönergesinin temel gereksinimlerine ve diğer ilgili hükümlerine uygun olduğunu bildirir. AB uygunluk bildiriminin tam metni şu adreste bulunabilir: <https://www.asus.com/support/>.

5150-5350 MHz arasındaki Wi-Fi çalışması, tabloda listelenen ülkeler için iç mekan kullanımla kısıtlanacaktır.

- Düşük Güç İç Mekan (LPI) Wi-Fi 5.945-6.425 GHz cihazları:  
Avusturya (AT), Belçika (BE), Bulgaristan (BG), Kıbrıs (CY), Çek Cumhuriyeti (CZ), Estonya (EE), Fransa (FR), Almanya (DE), İzlanda (IS), İrlanda (IE), Letonya (LV), Lüksemburg (LU), Hollanda (NL), Norveç (NO), Romanya (RO), Slovakya (SK), Slovenya (SI), İspanya (ES), İsviçre (CH)'da 5945 ile 6425 Mhz frekans aralığında çalışırken cihaz yalnızca iç mekanda kullanılır ile sınırlandırılmıştır.
- Çok Düşük Güç (VLP) Wi-Fi 5.945-6.425 GHz cihazları (taşınabilir cihazlar):  
Avusturya (AT), Belçika (BE), Bulgaristan (BG), Kıbrıs (CY), Çek Cumhuriyeti (CZ), Estonya (EE), Fransa (FR), Almanya (DE), İzlanda (IS), İrlanda (IE), Letonya (LV), Lüksemburg (LU), Hollanda (NL), Norveç (NO), Romanya (RO), Slovakya (SK), Slovenya (SI), İspanya (ES), İsviçre (CH)'da 5945 ile 6425 Mhz frekans aralığında çalışırken cihazın İnsansız Hava Aracı Sistemleri (UAS)'ta kullanımını izini değildir.

### Спрощена декларація про відповідність нормам ЄС

ASUSTek Computer Inc. заявляє, що цей пристрій відповідає основним вимогам та іншим відповідним вимогам Директиви 2014 / 53 / EU. Повний текст декларації відповідності нормам ЄС доступний на <https://www.asus.com/support/>.

Робота Wi-Fi на частоті 5150-5350 МГц обмежується використанням у приміщенні для країн, поданих у таблиці нижче:

- Пристрої низької потужності для приміщень (LPI) Wi-Fi 5,945–6,425 ГГц.  
Використання пристрою обмежено лише приміщенням із діапазоном частот від 5945 МГц до 6425 МГц у Австрії (AT), Бельгії (BE), Болгарії (BG), на Кіпрі (CY), у Чеській Республіці (CZ), Естонії (EE), Франції (FR), Німеччині (DE), Ісландії (IS), Ірландії (IE), Латвії (LV), Люксембурзі (LU), Нідерландах (NL), Норвегії (NO), Румунії (RO), Словаччині (SK), Словенії (SI), Іспанії (ES), Швейцарії (CH).
- Пристрої дуже низької потужності (VLP) Wi-Fi 5,945–6,425 ГГц (портативні пристрої).  
Використання пристрою не дозволено на безпілотних літальних апаратах (UAS) із діапазоном частот від 5945 МГц до 6425 МГц у Австрії (AT), Бельгії (BE), Болгарії (BG), на Кіпрі (CY), у Чеській Республіці (CZ), Естонії (EE), Франції (FR), Німеччині (DE), Ісландії (IS), Ірландії (IE), Латвії (LV), Люксембурзі (LU), Нідерландах (NL), Норвегії (NO), Румунії (RO), Словаччині (SK), Словенії (SI), Іспанії (ES), Швейцарії (CH).



AT	BE	BG	CZ	DK	EE	FR
DE	IS	IE	IT	EL	ES	CY
LV	LI	LT	LU	HU	MT	NL
NO	PL	PT	RO	SI	SK	TR
FI	SE	CH	HR	UK(NI)		

### CE RED RF Output table (Directive 2014/53/EU)

Model: RTL8515BE

Function	Frequency	Maximum Output Power EIRP (mW)
WiFi	2.4 - 2.4835 GHz	<100
	5.15 - 5.35 GHz	<200
	5.47 - 5.725 GHz	<200
	5.725 - 5.875 GHz*	<25
	5.925 - 6.425 GHz	<200
Bluetooth	2.4 - 2.4835 GHz	<100

Receiver category 1

\* Non-Intel modules: 5.725 - 5.85 GHz

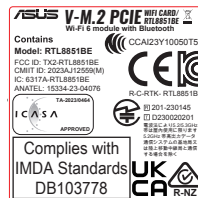

# Notices for non Wi-Fi model

## Compliance Statement of Innovation, Science and Economic Development Canada (ISED)

This device complies with Innovation, Science and Economic Development Canada licence exempt RSS standard(s). Operation is subject to the following two conditions: (1) this device may not cause interference, and (2) this device must accept any interference, including interference that may cause undesired operation of the device.

CAN ICES(B)/NMB(B)

## Déclaration de conformité de Innovation, Sciences et Développement économique Canada (ISED)

Le présent appareil est conforme aux CNR d'Innovation, Sciences et Développement économique Canada applicables aux appareils radio exempts de licence. L'exploitation est autorisée aux deux conditions suivantes : (1) l'appareil ne doit pas produire de brouillage, et (2) l'utilisateur de l'appareil doit accepter tout brouillage radioélectrique subi, même si le brouillage est susceptible d'en compromettre le fonctionnement.

CAN ICES(B)/NMB(B)

## Simplified UKCA Declaration of Conformity

ASUSTeK Computer Inc. hereby declares that this device is in compliance with the essential requirements and other relevant provisions of related UKCA Directives. Full text of UKCA declaration of conformity is available at: [www.asus.com/support](http://www.asus.com/support)

## Simplified EU Declaration of Conformity

English ASUSTeK Computer Inc. hereby declares that this device is in compliance with the essential requirements and other relevant provisions of related Directives. Full text of EU declaration of conformity is available at: [www.asus.com/support](http://www.asus.com/support)

Français ASUSTeK Computer Inc. déclare par la présente que cet appareil est conforme aux critères essentiels et autres clauses pertinentes des directives concernées. La déclaration de conformité de l'UE peut être téléchargée à partir du site Internet suivant : [www.asus.com/support](http://www.asus.com/support)

Deutsch ASUSTeK Computer Inc. erklärt hiermit, dass dieses Gerät mit den wesentlichen Anforderungen und anderen relevanten Bestimmungen der zugehörigen Richtlinien übereinstimmt. Der gesamte Text der EU-Konformitätserklärung ist verfügbar unter: [www.asus.com/support](http://www.asus.com/support)

Italiano ASUSTeK Computer Inc. con la presente dichiara che questo dispositivo è conforme ai requisiti essenziali e alle altre disposizioni pertinenti con le direttive correlate. Il testo completo della dichiarazione di conformità UE è disponibile all'indirizzo: [www.asus.com/support](http://www.asus.com/support)

Русский Компания ASUS заявляет, что это устройство соответствует основным требованиям и другим соответствующим условиям соответствующих директив. Подробную информацию, пожалуйста, смотрите на [www.asus.com/support](http://www.asus.com/support)

Български С настоящото ASUSTeK Computer Inc. декларира, че това устройство е в съответствие със съществените изисквания и другите приложими постановления на свързаните директиви. Пълният текст на декларацията за съответствие на ЕС е достъпна на адрес: [www.asus.com/support](http://www.asus.com/support)

Hrvatski ASUSTeK Computer Inc. ovim izjavljuje da je ovaj uređaj sukladan s bitnim zahtjevima i ostalim odgovarajućim odredbama vezanih direktiva. Cijeli tekst EU izjave o sukladnosti dostupan je na: [www.asus.com/support](http://www.asus.com/support)

Čeština Společnost ASUSTeK Computer Inc. tímto prohlašuje, že toto zařízení splňuje základní požadavky a další příslušná ustanovení souvisejících směrnic. Plné znění prohlášení o shodě EU je k dispozici na adrese: [www.asus.com/support](http://www.asus.com/support)

Dansk ASUSTeK Computer Inc. erklærer hermed, at denne enhed er i overensstemmelse med hovedkravene og andre relevante bestemmelser i de relaterede direktiver. Hele EU-overensstemmelseserklæringen kan findes på: [www.asus.com/support](http://www.asus.com/support)

Nederlands ASUSTeK Computer Inc. verklaart hierbij dat dit apparaat voldoet aan de essentiële vereisten en andere relevante bepalingen van de verwante richtlijnen. De volledige tekst van de EU-verklaring van conformiteit is beschikbaar op: [www.asus.com/support](http://www.asus.com/support)

Eesti Käesolevaga kinnitab ASUSTeK Computer Inc. et see seade vastab asjakohaste direktiivide olulistele nõuetele ja teistele asjassepuutuvatele sätetele. EL vastavusdeklaratsiooni täielik tekst on saadaval järgmisel aadressil: [www.asus.com/support](http://www.asus.com/support)

Suomi ASUSTeK Computer Inc. ilmoittaa täten, että tämä laite on asiaankuuluvien direktiivien olennaisten vaatimusten ja muiden tätä koskevien säädösten mukainen. EU-yhdenmukaisuusilmoituksen koko teksti on luettavissa osoitteessa: [www.asus.com/support](http://www.asus.com/support)

Ελληνικά Με το παρόν, η ASUSTeK Computer Inc. δηλώνει ότι αυτή η συσκευή συμμορφώνεται με τις θεμελιώδεις απαιτήσεις και άλλες σχετικές διατάξεις των οδηγιών της ΕΕ. Το πλήρες κείμενο της δήλωσης συμμόρφωσης είναι διαθέσιμο στη διεύθυνση: [www.asus.com/support](http://www.asus.com/support)

Magyar Az ASUSTeK Computer Inc. ezennel kijelenti, hogy ez az eszköz megfelel a kapcsolódó irányelvek lényeges követelményeinek és egyéb vonatkozó rendelkezéseinek. Az EU megfelelőségi nyilatkozat teljes szövege innen letölthető: [www.asus.com/support](http://www.asus.com/support)

Latviski ASUSTeK Computer Inc. ar šo paziņo, ka šī ierīce atbilst saistīto Direktīvu būtiskajām prasībām un citiem citiem saistošajiem nosacījumiem. Pilns ES atbilstības paziņojuma teksts pieejams šeit: [www.asus.com/support](http://www.asus.com/support)

**Lietuvių** „ASUSTeK Computer Inc.“ šiuo tvirtina, kad šis įrenginys atitinka pagrindinius reikalavimus ir kitas svarbias susijusių direktyvų nuostatas. Visą ES atitikties deklaracijos tekstą galima rasti: [www.asus.com/support](http://www.asus.com/support)

**Norsk** ASUSTeK Computer Inc. erklærer herved at denne enheten er i samsvar med hovedsaklige krav og andre relevante forskrifter i relaterte direktiver. Fullstendig tekst for EU-samsvarserklæringen finnes på: [www.asus.com/support](http://www.asus.com/support)

**Polski** Firma ASUSTeK Computer Inc. niniejszym oświadcza, że urządzenie to jest zgodne z zasadniczymi wymogami i innymi właściwymi postanowieniami powiązanych dyrektyw. Pełny tekst deklaracji zgodności UE jest dostępny pod adresem: [www.asus.com/support](http://www.asus.com/support)

**Português** A ASUSTeK Computer Inc. declara que este dispositivo está em conformidade com os requisitos essenciais e outras disposições relevantes das Diretivas relacionadas. Texto integral da declaração da UE disponível em: [www.asus.com/support](http://www.asus.com/support)

**Română** ASUSTeK Computer Inc. declară că acest dispozitiv se conformează cerințelor esențiale și altor prevederi relevante ale directivelor conexe. Textul complet al declarației de conformitate a Uniunii Europene se găsește la: [www.asus.com/support](http://www.asus.com/support)

**Srpski** ASUSTeK Computer Inc. ovim izjavljuje da je ovaj uređaj u saglasnosti sa osnovnim zahtevima i drugim relevantnim odredbama povezanih Direktiva. Pun tekst EU deklaracije o usaglašenosti je dostupan na adresi: [www.asus.com/support](http://www.asus.com/support)

**Slovensky** Spoločnosť ASUSTeK Computer Inc. týmto vyhlasuje, že toto zariadenie vyhovuje základným požiadavkám a ostatným príslušným ustanoveniam príslušných smerníc. Celý text vyhlásenia o zhode pre štáty EÚ je dostupný na adrese: [www.asus.com/support](http://www.asus.com/support)

**Slovenščina** ASUSTeK Computer Inc. izjavlja, da je ta naprava skladna z bistvenimi zahtevami in drugimi ustreznimi določbami povezanih direktiv. Celotno besedilo EU-izjave o skladnosti je na voljo na spletnem mestu: [www.asus.com/support](http://www.asus.com/support)

**Español** Por la presente, ASUSTeK Computer Inc. declara que este dispositivo cumple los requisitos básicos y otras disposiciones pertinentes de las directivas relacionadas. El texto completo de la declaración de la UE de conformidad está disponible en: [www.asus.com/support](http://www.asus.com/support)

**Svenska** ASUSTeK Computer Inc. förklarar härmed att denna enhet överensstämmer med de grundläggande kraven och andra relevanta föreskrifter i relaterade direktiv. Fulltext av EU-försäkran om överensstämmelse finns på: [www.asus.com/support](http://www.asus.com/support)

**Türkçe** ASUSTeK Computer Inc., bu aygıtın temel gereksinimlerle ve ilişkili Yönergelerin diğer ilgili koşullarına uyumlu olduğunu beyan eder. AB uygunluk bildiriminin tam metni şu adreste bulunabilir: [www.asus.com/support](http://www.asus.com/support)

**Українська** ASUSTeK Computer Inc. заявляє, що цей пристрій відповідає основним вимогам та іншим відповідним положенням відповідних Директив. Повний текст декларації відповідності стандартам ЄС доступний на: [www.asus.com/support](http://www.asus.com/support)

**Bosnian** ASUSTeK Computer Inc. ovim izjavljuje da je ovaj uređaj usklađen sa bitnim zahtjevima i ostalim odgovarajućim odredbama vezanih direktiva. Kompletan tekst EU deklaracije o usklađenosti dostupan je na: [www.asus.com/support](http://www.asus.com/support)

**עברית** בזאת, ASUSTeK Computer Inc. מתחירה כי תואם לדרשות החיוביות ולתאים הרלוונטיים האחרים של ההחיות הקשורות. הטקסט המלא של הצהרת התאימות של האיחוד האיחופי זמין בכתובת: [www.asus.com/support](http://www.asus.com/support)

# Warranty

## EN: ASUS Guarantee Information

- ASUS offers a voluntary manufacturer's Commercial Guarantee.
- ASUS reserves the right to interpret the provisions of the ASUS Commercial Guarantee.
- This ASUS Commercial Guarantee is provided independently and in addition to the statutory Legal Guarantee and in no way affects or limits the rights under the Legal Guarantee.

For all the guarantee information, please visit <https://www.asus.com/support>.

## FR: Garantie ASUS

- ASUS fournit une garantie commerciale en tant que garantie volontaire du fabricant.
- ASUS se réserve le droit d'interpréter et de clarifier les informations relatives à la garantie commerciale ASUS.
- Cette garantie commerciale ASUS est fournie indépendamment et parallèlement à la garantie légale, elle n'affecte ou ne limite d'aucune façon les droits acquis par la garantie légale.

Pour plus d'informations sur la garantie, consultez le site <https://www.asus.com/fr/support/>.

## G: ASUS Garantieinformationen

- ASUS bietet eine freiwillige Warengarantie des Herstellers an.
- ASUS behält sich das Recht zur Auslegung der Bestimmungen in der ASUS Warengarantie vor.
- Diese ASUS Warengarantie wird unabhängig und zusätzlich zur rechtmäßigen gesetzlichen Garantie gewährt und beeinträchtigt oder beschränkt in keiner Weise die Rechte aus der gesetzlichen Garantie.

Die vollständigen Garantieinformationen finden Sie unter <https://www.asus.com/de/support/>.

## I: Informativa sulla Garanzia ASUS

- ASUS offre una Garanzia Commerciale volontaria del produttore.
- ASUS si riserva il diritto di interpretare le disposizioni della Garanzia Commerciale ASUS.
- La presente Garanzia Commerciale ASUS viene fornita in modo indipendente e in aggiunta alla Garanzia Legale prevista per legge e non pregiudica o limita in alcun modo i diritti previsti dalla Garanzia Legale.

Per tutte le informazioni sulla garanzia, visitare <https://www.asus.com/it/support>.

## R: Информация о гарантиии ASUS

- ASUS предлагает добровольную гарантию от производителя.
- ASUS оставляет за собой право интерпретирования положений гарантии ASUS.
- Настоящая гарантия ASUS никоим образом не ограничивает Ваши права, предусмотренные локальным законодательством.

Для получения полной информации о гарантии посетите <https://www.asus.com/ru/support/>.

## BG: Информация за гаранцията от ASUS

- ASUS предлага доброволна търговска гаранция от производителя.
- ASUS си запазва правото да тълкува условията на търговската гаранция на ASUS.
- Тази търговска гаранция на ASUS се предлага независимо от и в допълнение на законната гаранция. Тя по никакъв начин не оказва влияние върху правата на потребителя в законната гаранция и по никакъв начин не ги ограничава.

За цялостна информация относно гаранцията, моля, посетете <https://www.asus.com/support>.

## CR: Informacije o ASUS jamstvu

- ASUS dragovoljno nudi komercijalno proizvođačko jamstvo.
- ASUS zadržava prava na tumačenje odredbi ASUS komercijalnog jamstva.
- Ovo ASUS komercijalno jamstvo daje se neovisno i kao dodatka zakonskom jamstvu i ni na koji način ne ograničuje prava iz okvira zakonskog jamstva.

Sve informacije o jamstvu potražite na <https://www.asus.com/support>.

## CZ: Informace o záruce společnosti ASUS

- Společnost ASUS nabízí dobrovolnou komerční záruku výrobce.
- Společnost ASUS si vyhrazuje právo vykládat ustanovení komerční záruky společnosti ASUS.
- Tato komerční záruka společnosti ASUS je poskytována nezávisle a jako doplněk zákonné záruky a žádným způsobem neovlivňuje ani neomezuje práva vyplývající ze zákonné záruky.

Všechny informace o záruce najdete na adrese <https://www.asus.com/cz/support/>.

## DA: ASUS garantioplysninger

- ASUS tilbyder en valgfri handelsmæssig garanti.
- ASUS forbeholder sig retten til at fortolke bestemmelserne i ASUS' handelsmæssige garanti.
- Denne handelsmæssige garanti fra ASUS tilbydes uafhængigt, som en tilføjelse til den lovbestemte juridiske garanti og den påvirkede eller begrænser på ingen måde rettighederne i den juridiske garanti.

Alle garantioplysningerne kan findes på <https://www.asus.com/dk/support/>.

## DU: ASUS-garantie-informatie

- ASUS biedt een vrijwillige commerciële garantie van de fabrikant.
- ASUS behoudt zich het recht voor om de bepalingen van de commerciële garantie van ASUS uit te leggen.
- Deze commerciële garantie van ASUS wordt onafhankelijk en als aanvulling op de statutaire Wettelijke garantie geboden en beïnvloedt of beperkt in geen geval de rechten onder de wettelijke garantie.

Voor alle informatie over de garantie, gaat u naar <https://www.asus.com/nl/support/>.

## EE: Teave ASUS-e garantii kohta

- ASUS pakub vabatahtlikku tasulist tootjagarantiid.
- ASUS jätab endale õiguse tõlgendada ASUS-e tasulise garantii tingimusi.
- See ASUS-e tasuline garanti on sõltumatu lisagarantiid seadusega kehtestatud garantiile ega mõjuta mingil määral seadusega kehtestatud garantiid ning seadusega kehtestatud garantiid piiranguid.

Vaadake garantiga seotud teavet veebisaidil <https://www.asus.com/ee/>.

## FI: ASUS-takuutiedot

- ASUS tarjoaa vapaaehtoisien valmistajan kaupallisen takuun.
- ASUS pidättää oikeuden tulkita ASUS-kaupallisen takuun ehdot.
- Tämä ASUS-kaupallinen takuu tarjotaan itsenäisesti lakisäätöiden oikeudellisten takuun lisäksi eikä se vaikuta millään tavoin laillisen takuun oikeuksiin tai rajoita niitä.

Saadaksesi kaikki takuutiedot, siirry osoitteeseen <https://www.asus.com/fi/support/>.

## GK: Πληροφορίες εγγύησης ASUS

- Η ASUS προσφέρει μια εθελοντική Εμπορική εγγύηση κατασκευαστή.
- Η ASUS διατηρεί το δικαίωμα ερμηνείας των διατάξεων της Εμπορικής εγγύησης ASUS.
- Αυτή η Εμπορική εγγύηση ASUS παρέχεται ανεξάρτητα και επιπροσβέτως της θεσμικής Νομικής εγγύησης και σε καμία περίπτωση δεν επηρεάζει ή περιορίζει τα δικαιώματα βάσει της Νομικής εγγύησης.

Για όλες τις πληροφορίες εγγύησης, επισκεφθείτε τη διεύθυνση <https://www.asus.com/gr/el/>.

## HUG: ASUS garanciális információk

- Az ASUS önkéntes gyártói kereskedelmi garanciát kínál.
- Az ASUS fenntartja magának a jogot, hogy értelmezze az ASUS kereskedelmi garanciára vonatkozó rendelkezéseket.
- Ezt a kereskedelmi garanciát az ASUS függetlenül és a törvényes garancia mellett nyújtja és semmilyen módon nem befolyásolja, vagy korlátozza a jogi garancia nyújtotta jogokat.

A garanciára vonatkozó teljes körű információkért látogasson el a <https://www.asus.com/hu/support/oldira>.

## LT: Informacija apie ASUS garantiją

- ASUS siūlo savanorišką komercinę gamintojo garantiją.
- ASUS pasilikta teisę savo nuožūria aiškinti šios komercinės ASUS garantijos nuostatas.
- Ši komercinė ASUS garantija suteikiama nepriklausoma, be įstatyminės teisinės garantijos, ir joki būdu nepaveikia ar neapriboja teisinės garantijos suteikiamų teisių.

Norėdami gauti visa informaciją apie garantiją, apsilankykite <https://www.asus.com/lt/>.

## LV: ASUS garantijas informācija

- ASUS piedāvā brīvprātīgu ražotāja komerciālo garantiju.
- ASUS patur tiesības interpretēt ASUS komerciālās garantijas noteikumus.
- Šī ASUS komerciālā garantija tiek piedāvāta neatkarīgi un papildus likumā noteiktajai juridiskajai garantijai, un tā nekādā mērķē veidā neierobežo juridiskajai garantijai noteiktās tiesības.

Lai iegūtu informāciju par garantiju, apmeklējiet vietni <https://www.asus.com/lv/>.

**MX: Garantía y Soporte**

Esta Garantía aplica en el país de compra. Usted acepta que en esta garantía:

- Los procedimientos de servicio pueden variar en función del país.
- Algunos servicios y/o piezas de reemplazo pueden no estar disponibles en todos los países.
- Algunos países pueden tener tarifas y restricciones que se apliquen en el momento de realizar el servicio, visite el sitio de soporte de ASUS en <https://www.asus.com/mx/support/> para ver más detalles.
- Si tiene alguna queja o necesidad de un centro de reparación local o el periodo de garantía del producto ASUS, por favor visite el sitio de Soporte de ASUS en <https://www.asus.com/mx/support/> para mayores detalles.

**Información de contacto ASUS**

Esta garantía está respaldada por:  
ASUSTeK Computer Inc.  
Centro de Atención ASUS +52 (55) 1946-3663

**NO: Informasjon om ASUS-garanti**

- ASUS tilbyr som produsent en frivillig kommersiell garanti.
- ASUS forbeholder seg retten til å tolke bestemmelsene i ASUS sin kommersielle garanti.
- ASUS sin kommersielle garanti gir uavhengig og i tillegg til den lovbestemte juridiske garantien, og verken påvirker eller begrenser rettighetene under den juridiske garantien på noen måte.

Du finner fullstendig informasjon om garanti på <https://www.asus.com/no/support/>.

**PG: Informações de Garantia ASUS**

- A ASUS oferece uma Garantia Comercial voluntária do fabricante.
- A ASUS reserva o direito de interpretar as disposições da Garantia Comercial da ASUS.
- Esta Garantia Comercial da ASUS é fornecida de forma independente além da Garantia Legal estatutária e não afeta nem limita de qualquer forma os direitos estabelecidos na Garantia Legal.

Para consultar todas as informações sobre a garantia, visite <https://www.asus.com/pt/support/>.

**PL: Informacje o gwarancji firmy ASUS**

- Firma ASUS oferuje dobrowolną gwarancję handlową producenta.
- Firma ASUS zastrzega sobie prawo do interpretacji warunków gwarancji handlowej firmy ASUS.
- Niniejsza gwarancja handlowa firmy ASUS jest udzielana niezależnie, jako dodatek do wymaganej ustawowo gwarancji prawnej i w żaden sposób nie wpływa na prawa przysługujące na mocy gwarancji prawnej ani ich nie ogranicza.

Wszelkie informacje na temat gwarancji można znaleźć na stronie <https://www.asus.com/pl/support>.

**RO: Informații despre garanția ASUS**

- ASUS oferă o garanție comercială voluntară a producătorului.
- ASUS își rezervă dreptul de a interpreta prevederile garanției comerciale ASUS.
- Această garanție comercială ASUS este oferită independent și în plus față de garanția obligatorie legală și nu afectează sau limitează în niciun fel drepturile acordate conform garanției legale.

Pentru toate informațiile legate de garanție, vizitați <https://www.asus.com/ro/support>.

**S: Información de garantía de ASUS**

- ASUS ofrece una garantía comercial voluntaria del fabricante.
- ASUS se reserva el derecho de interpretar las disposiciones de esta garantía comercial de ASUS.
- Esta garantía comercial de ASUS se proporciona de forma independiente y adicional a la garantía estatutaria y de ninguna manera afecta a los derechos bajo la garantía legal ni los limita.

Para obtener toda la información sobre la garantía, visite <https://www.asus.com/ES/support/>.

**SB: Informacje o ASUS gwarancji**

- ASUS nudi dobrowolnu proizvođačku komercijalnu gwaranciju.
- ASUS zadržava pravo da tumači odredbe svoje ASUS komercijalne gwarancije.
- Ova ASUS komercijalna gwarancija daje se nezavisno, kao dodatak zakonskoj pravnoj gwaranciji, i ni ka koji način ne utiče na i ne ograničava prava data pravnom gwarancijom.

Za sve informacije o gwaranciji, posetite <https://www.asus.com/support/>.

**SK: Informácie o záruke ASUS**

- ASUS ponúka dobrovoľnú obchodnú záruku výrobcu.
- ASUS si vyhradzuje právo interpretovať ustanovenia obchodnej záruky ASUS.
- Táto obchodná záruka ASUS je poskytnutá nezávisle a navyše k zákonnej záruke a v zhladnom prípade neovplyvňuje ani neobmedzuje tieto práva podľa tejto zákonnej záruky.

Všetky ďalšie informácie o záruke nájdete na <https://www.asus.com/sk/support>.

**SL: Informacije o garanciji ASUS**

- ASUS ponuja prostovoljno tržno garancijo proizvajalca.
- ASUS si pridržuje pravico do razlage določb tržne garancije družbe ASUS.
- Ta tržna garancija družbe ASUS je na voljo neodvisno in kot dodatek zakonsko predpisani pravni garanciji ter na noben način ne vpliva na pravice, ki jih zagotavlja pravna garancija, oziroma jih omejuje.

Vse informacije o garanciji najdete na spletnem mestu <https://www.asus.com>.

**SW: ASUS garantinformasjon**

- ASUS erbjuder en frivillig kommersiell tilkenningsgaranti.
- ASUS forbeholder sig retten att tolka bestemmelserna i ASUS kommersielle garanti.
- Denna kommersielle garanti från ASUS tillhandahålles separat och som tillägg till den lagstadgade garantin, och påverkar eller begränsar på intet sätt rättigheterna under den lagstadgade garantin.

För all garantiformation, besök <https://www.asus.com/se/support/>.

**TR: ASUS Garanti Bilgileri**

- ASUS, gönüllü olarak üretici Ticari Garantisini sunar.
- ASUS, ASUS Ticari Garantisinin hükümlerini yorumlama hakkını saklı tutar.
- Bu ASUS Ticari Garantisini, bağımsız olarak ve hukuki Yasal Garanti'ye ek olarak sağlar ve hiçbir şekilde Yasal Garanti kapsamındaki hakları etkilemez veya sınırlamaz.

Tüm garanti bilgileri için lütfen <https://www.asus.com/tr/support> adresini ziyaret edin.

**UA: Інформація про Гарантію ASUS**

- ASUS пропонує добровільну Комерційну Гарантію виробника.
- ASUS застерігає за собою право тлумачити положення Комерційної Гарантії ASUS.
- Цю Комерційну Гарантію надано незалежно і на додаток до обов'язкової Законної Гарантії; вона жодним чином не впливає на права за Законом Гарантію і не обмежує їх.

Всю інформацію про гарантію подано тут: <https://www.asus.com/ua/support>.

Компанія ASUS не несе відповідальності за шкodu, заподіяну життя, здоров'ю чи майну користувача або інших осіб внаслідок використання несправного Виробу або такого Виробу, що не пройшов діагностику після закінчення терміну служби.

З метою перевірки технічного стану Виробу та визначення безпеки його подальшого використання після закінчення терміну служби користувачу необхідно припинити використання Виробу та передати його в авторизований сервісний центр компанії ASUS протягом одного місяця з моменту виявлення пошкодження та/або закінчення терміну служби Виробу.

**BP: Informações de garantia ASUS**

Esta garantia aplica-se ao período definido pela garantia legal (90 dias) mais o período de garantia comercial oferecido pela ASUS. Por exemplo: 12M significa 12 meses de garantia no total (3 meses de garantia legal mais 9 meses de garantia contratual). 24 meses significa 24 meses de garantia no total (3 meses de garantia legal mais 21 meses de garantia contratual) e 36 meses significa 36 meses de garantia no total (3 meses de garantia legal e 33 de garantia contratual) a contar da data da garantia declarada (Data de Inicio da Garantia).

Para todas as informações de garantia, visite <https://www.asus.com/br/support/>.

**VN: Thông tin đảm bảo của ASUS**

- ASUS cung cấp Bảo hành thương mại tự nguyện của nhà sản xuất.
- ASUS bảo lưu quyền giải thích các điều khoản của Bảo hành thương mại của ASUS.
- Bảo hành thương mại này của ASUS được cung cấp độc lập và ngoài Bảo đảm pháp lý theo luật định và không có cách nào ảnh hưởng đến hoặc giới hạn các quyền theo Bảo lãnh pháp lý. Để biết tất cả các thông tin bảo hành, vui lòng truy cập

<https://www.asus.com/vn/support>

**ID: Informasi Garansi ASUS**

Periode garansi untuk Mainboard adalah 0 bulan dan Mainboard Workstation adalah 72 bulan Masa ("Garansi") sejak tanggal produk pertama kali dibeli oleh pelanggan akhir ("Tanggal Pembelian"). \* Silakan kunjungi situs Dukungan ASUS di <https://www.asus.com/id/support/warranty-status-inquiry/> untuk detail lebih lanjut. Jika bukti pembelian tidak dapat diberikan, tanggal produksi yang dicatat oleh ASUS akan dianggap sebagai awal dari Masa Garansi. Silahkan pindai Kode QR di bagian bawah halaman terakhir untuk Kartu Garansi versi Web dalam format PDF untuk lebih informasi jelas mengenai jaminan garansi Produk ASUS. Layanan Call Center Nomor Telepon: 1500128 (Senin-Jumat 09.30-17.00, Sabtu 09.30-12.00)

**:HB מידע על אחריות ASUS**

- ASUS מציעה אחריות מסחרית של יצרן מרצון.
- ASUS שומרת לעצמה את הזכות לפרש את הוראות הערבות המסחרית של ASUS
- אחריות מסחרית זו של ASUS ניתנת באופן עצמאי ויבוסף לערבות המשפטית ההסטורית ואינה משפיעה או מגבילה בשום אופן את הזכויות במסגרת הערבות המשפטית.

למידע אודות האחריות, אנא בקר ב  
<https://www.asus.com/support>

No.	Kota	Provinsi	Alamat	Jam Kerja
1	Jakarta Pusat	Jakarta	Ruko Manggo Dua Mall No. RM-22, Jl. Mangga Dua Raya No.1, RT.1/RW.12, Mangga Dua Sel., Kecamatan Sawah Besar, Kota Jakarta Pusat, Daerah Khusus Ibukota Jakarta 10730	Senin-Jumat 09.30-17.00, Sabtu 09.30-12.00
2	Surabaya	Jawa Timur	Jl. Klampis Jaya No. 39, Surabaya, Jawa Timur, Indonesia, 60117	Senin-Jumat 09.30-17.00, Sabtu 09.30-12.00
3	Denpasar	Bali	Jl. Teuku Umar Barat No.888D, Denpasar, Bali, Indonesia, 80117	Senin-Jumat 09.30-17.00, Sabtu 09.30-12.00



Warranty Card (Online)

## ASUS contact information

### **ASUSTeK COMPUTER INC.**

Address: 1F., No. 15, Lide Rd., Beitou Dist., Taipei City 112  
<https://qr.asus.com/ProductSafety>

### **ASUS COMPUTER INTERNATIONAL (America)**

Address: 48720 Kato Rd., Fremont, CA 94538, USA

### **ASUS COMPUTER GmbH (Germany and Austria)**

Address: Harkortstrasse 21-23, 40880 Ratingen, Germany

### **ASUSTeK (UK) LIMITED**

Address: 1st Floor, Sackville House, 143-149 Fenchurch Street, London, EC3M 6BL, England,  
United Kingdom

### **ASUS GLOBAL PTE. LTD.**

Address: 10 Changi Business Park Central 2 #02-01 Hansapoint Singapore 486030  
<https://qr.asus.com/ProductSafety>

## Service and support

Visit our multi-language website at <https://www.asus.com/support>.



## Product register

Log in and register your device for better product support.

